



**DEPARTMENT OF THE NAVY**  
HEADQUARTERS UNITED STATES MARINE CORPS  
2 NAVY ANNEX  
WASHINGTON, DC 20380-1775

MCO P5060.20  
C 06  
5 May 03

MARINE CORPS ORDER P5060.20 W/CH 1

From: Commandant of the Marine Corps  
To: Distribution List

Subj: MARINE CORPS DRILL AND CEREMONIES MANUAL

Ref: (a) Marine Corps Manual

Encl: (1) Locator Sheet

1. Purpose. The Marine Corps Drill and Ceremonies Manual is designed to provide uniformity and standardization for all Marine Corps organizations. This Manual prescribes procedures for all close order drill and military ceremonial evolutions.

2. Cancellation. NAVMC 2691.

3. Summary of Revision. This Manual has been revised to incorporate minor changes to existing procedures and rearrange material more logically. Additionally, a large amount of new information has been added to the Manual. This Manual should be reviewed in its entirety.

4. Scope. This Manual encompasses all close order drill procedures for use by Marine Corps organizations with the exception of Marine Barracks, Washington, DC. The ceremonies outlined in this Manual are those traditionally executed by Marine Corps units. The only deviation from procedures outlined in this Manual are those authorized by specific provisions of the Manual.

5. Recommendation of Modification. Recommendations for improving or modifying the Marine Corps Drill and Ceremonies Manual are invited. Recommended changes will be submitted to the CG, Training and Education Command (TECOM), Quantico, VA.

**DISTRIBUTION STATEMENT A: Approved for public release; distribution is unlimited**

MCO P5060.20

5 May 03

6. Action. COs and all personnel shall familiarize themselves with this Manual.

7. Reserve Applicability. This Manual is applicable to the Marine Corps Reserve.

8. Certification. Reviewed and approved this date.

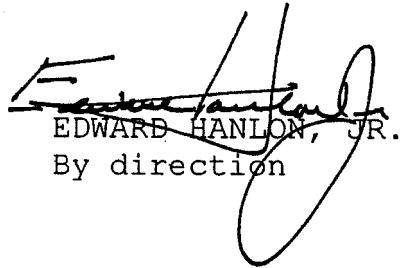
  
EDWARD HANLON, JR.  
By direction

DISTRIBUTION: PCN 10207170600

Copy to: 8145001 (1)



DEPARTMENT OF THE NAVY  
HEADQUARTERS UNITED STATES MARINE CORPS  
2 NAVY ANNEX  
WASHINGTON, DC 20380-1775

MCO P5060.20 Ch 1  
C 06  
04 OCT 2006

MARINE CORPS ORDER P5060.20 Ch 1

From: Commandant of the Marine Corps  
To: Distribution List

Subj: MARINE CORPS DRILL AND CEREMONIES MANUAL

Encl: (1) New page inserts to MCO P5060.20

1. Purpose. To transmit new pages to MCO P5060.20.

2. Action

a. Remove pages 5-8, 5-15, 5-16, 5-20, and 5-26 of the basic order and replace with pages 5-8, 5-15, 5-16, 5-20, and 5-26 of the enclosure.

b. Remove page 6-10 of the basic order and replace with 6-10 of the enclosure.

c. Remove pages 7-5, 7-6, 7-7, 7-9, 7-12, 7-13, 7-28, 7-33, 7-40, and 7-47 of the basic order and replace with pages 7-5, 7-6, 7-7, 7-9, 7-12, 7-13, 7-28, 7-33, 7-40, and 7-47 of the enclosure.

d. Remove pages 10-4 and 10-18 of the basic order and replace with pages 10-4 and 10-18 of the enclosure.

e. Remove page 11-6 of the basic order and replace with page 11-6 of the enclosure.

f. Remove page 13-7 of the basic order and replace with page 13-7 of the enclosure.

g. Remove pages 14-3, 14-4, 14-5, 14-7, 14-8, 14-9, 14-10, and 14-11 of the basic order and replace with pages 14-3, 14-4, 14-5, 14-7, 14-8, 14-9, 14-10, and 14-11 of the enclosure.

h. Remove page 15-6 of the basic order and replace with page 15-6 of the enclosure.

i. Remove pages 16-5, 16-7, 16-8, 16-10, and 16-11 of the basic order and replace with pages 16-5, 16-7, 16-8, 16-10, and 16-11 of the enclosure.

DISTRIBUTION STATEMENT A: Approved for public release; distribution is unlimited.

j. Remove pages 17-4, 17-5, 17-7, 17-8, 17-10, 17-11, 17-13, 17-14, 17-15, 17-16, 17-17, 17-18, 17-19, 17-20, 17-25, 17-26 of the basic order and 17-20 and replace with pages 17-4, 17-5, 17-7, 17-8, 17-10, 17-11, 17-13, 17-14, 17-15, 17-16, 17-17, 17-18, 17-19, 17-20, 17-25, 17-26 of the enclosure.

k. Remove pages 18-6, 18-7, 18-8, 18-9, 18-10, 18-12, and 18-16 of the basic order and replace with pages 18-6, 18-7, 18-8, 18-9, 18-10, 18-12, and 18-16 of the enclosure.

l. Remove pages 20-3, 20-4, 20-6, and 20-8 of the basic order and replace with pages 20-3, 20-4, 20-6, and 20-8 of the enclosure.

m. Remove pages 22-4 and 22-7 of the basic order and replace with pages 22-4 and 22-7 of the enclosure.

n. Remove pages 23-3, 23-4, 23-5, 23-6, 23-8, and 23-15 of the basic order and replace with pages 23-3, 23-4, 23-5, 23-6, 23-8, and 23-15 of the enclosure.

o. Remove pages 24-3 and 24-4 of the basic order and replace with pages 24-3 and 24-4 of the enclosure

p. Remove pages 25-11, 25-17, 25-18, and 25-19 of the basic order and replace with pages 25-11, 25-17, 25-18, and 25-19 of the enclosure.

3. Change Notation. Paragraphs denoted by an arrow (➔) symbol contain changes not previously published.

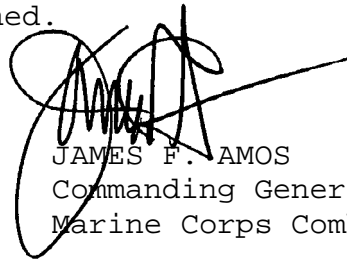

JAMES F. AMOS  
Commanding General  
Marine Corps Combat Development Command

DISTRIBUTION: PCN 10207170601

Copy to: 8145001 (1)

LOCATOR SHEET

Subj: MARINE CORPS DRILL AND CEREMONIES MANUAL

Location: \_\_\_\_\_  
(Indicate the location(s) of the copy(ies) of this Manual.)

MARINE CORPS DRILL AND CEREMONIES MANUAL

RECORD OF CHANGES

Log completed change action as indicated.

Change Number	Date of Change	Date Entered	Signature of Person Incorporating Change



MARINE CORPS DRILL AND CEREMONIES MANUAL

CONTENTS

CHAPTER

INTRODUCTION

PART I: DRILL

- 1 INTRODUCTION TO DRILL
- 2 INDIVIDUAL INSTRUCTIONS WITHOUT ARMS
- 3 MANUAL OF ARMS WITH THE M16 RIFLE
- 4 MANUAL OF ARMS WITH THE HANDGUN
- 5 SWORD MANUAL
- 6 GUIDON MANUAL
- 7 NATIONAL AND ORGANIZATIONAL FLAGS
- 8 SQUAD DRILL
- 9 PLATOON DRILL
- 10 COMPANY DRILL
- 11 BATTALION DRILL
- 12 REGIMENTAL DRILL
- 13 INSPECTIONS
- 14 ORGANIZATIONAL AND PARADE STAFF

PART II: CEREMONIES

- 15 GENERAL INFORMATION
- 16 REVIEWS
- 17 PARADES



# MARINE CORPS DRILL AND CEREMONIES MANUAL

## CONTENTS

### CHAPTER

- 18 PRESENTATION OF DECORATIONS AND INDIVIDUAL RETIREMENT
- 19 CHANGE OF COMMAND CEREMONY
- 20 RELIEF AND APPOINTMENT OF THE SERGEANT MAJOR
- 21 ACTIVATION AND DEACTIVATION CEREMONY
- 22 HONORS
- 23 MARINE CORPS BIRTHDAY CAKE CUTTING CEREMONY
- 24 MESS NIGHT
- 25 FUNERALS AND MEMORIAL SERVICES
- 26 LOADING AND CEREMONIAL FIRING OF THE M16 RIFLE

### APPENDIX

- A MANUAL OF ARMS WITH THE M1 SERVICE RIFLE
- B MANUAL OF ARMS WITH THE M14 SERVICE RIFLE
- C CEREMONIAL PROPERTY
- D HISTORY, CUSTOMS AND COURTESIES, AND TRADITIONS OF THE MESS NIGHT

# MARINE CORPS DRILL AND CEREMONIES MANUAL

## INTRODUCTION

One of the cornerstones of Marine Corps customs, courtesies and traditions is our execution of close order drill and ceremonies. These traditions are perpetuated from one generation to the next through constant use and practice. The "esprit de corps" of every Marine has been brought about by their ever-present feeling of pride, not only in their unit, but also in themselves. The preservation of traditional discipline, our customs and courtesies, and the heritage of our Corps is our duty. It is our further duty to see that the same high standard of discipline and esprit de corps is not only preserved, but also further strengthened. These intangibles must be passed on to the future Marines who will take their place among the ranks our Corps.

The object of close order drill is to teach Marines by exercise to obey orders and to do so immediately in the correct way. Close order drill is one foundation of discipline and esprit de corps. Additionally, it is still one of the finest methods for developing confidence and troop leading abilities in our subordinate leaders.

Ceremonial duties are written deep into our history as a Corps. It is no coincidence that among the units famous for ceremonial prowess and spit-and-polish are also to be found some of the worlds most redoubtable fighting formations. The hallmark of the world's fighting organizations, the Roman legions, the Spartans, the Foreign Legion, the British Brigade of Guards and many others is that they are as good on parade as they are in the field or in the attack. While we no longer use drill and formations to align the ranks as was done for the phalanxes of Rome or the squares of Waterloo, drill and ceremony is still the foundation of instilling and developing discipline in any size unit and the individual.

The Marine Corps has long enjoyed a worldwide reputation for sharp appearance and soldierly performance of duties. Our reputation as a Corps is built upon the legacy of those that came before us and puts us on par with the finest military organizations in the world's history. This reputation has been enhanced by continually demonstrating that our execution of peacetime functions is excelled only by our performance in battle.

The special distinction that the Marine Corps has today in regards to drill and ceremonies is best exemplified by the saying "*First on foot, and right on the line.*" This privilege bestowed on the Corps by the Secretary of the Navy on 9 August 1876, gives Marines the place of honor in any Naval formation.

Today we continue the tradition of excellence associated with drill. Beginning with OCS and recruit training we continue to use close order drill as the foundation for developing discipline and esprit de corps. This process is the first step that transforms the civilian into a Marine and then develops the teamwork and unit cohesion. This process then continues in the operating forces through the proper execution of drill and ceremonies to maintain the same level of discipline and esprit de corps found at entry-level training.

This Manual has been the work of many dedicated Marines, past and present. The members of the current drill committee owe all those who have contributed to this collaborative effort a debt of gratitude. Because of this the members of the drill committee in reviewing and updating this Manual have attempted to remain true to this heritage and the traditions of our Corps. This is the first drill manual of the 21<sup>st</sup> century and we have attempted to provide for the needs of a modern Marine Corps while remaining faithful to the traditions of our past. Extensive research was done to ensure historical accuracy for terms and procedures. Changes were made only to standardize usage and in some cases ensure compliance with other Marine Corps directives. Finally, the intent was to produce a manual that would be easy to use.

MARINE CORPS DRILL AND CEREMONIES MANUAL

PART I: DRILL

CHAPTER 1

INTRODUCTION TO DRILL

	<u>PARAGRAPH</u>	<u>PAGE</u>
GENERAL . . . . .	1000	1-3
DEFINITIONS . . . . .	1001	1-4
INSTRUCTING DRILL . . . . .	1002	1-10
INSTRUCTION GROUPS . . . . .	1003	1-11
COMMANDS AND THE COMMAND VOICE . . . . .	1004	1-11
GENERAL RULES FOR DRILL . . . . .	1005	1-14
DRILL BY THE NUMBERS . . . . .	1006	1-15
MASS COMMANDS AND INDIVIDUAL COMMANDS FROM RANKS . . . . .	1007	1-17
ADVANCED DRILL PROCEDURES . . . . .	1008	1-18
TABLE OF SYMBOLS USED IN THIS MANUAL . . . . .	1009	1-18

FIGURE

1-1a	CENTER (ODD NUMBER OF ELEMENTS), DEPTH, AND FRONT. . . . .	1-4
1-1b	CENTER, EVEN NUMBER OF ELEMENTS . . . . .	1-5
1-2	DISTANCE AND FILE . . . . .	1-6
1-3	INTERVAL AND RANK . . . . .	1-7
1-4	STRONG GRIP ON THE STAFF . . . . .	1-9
1-5	"V" GRIP ON THE STAFF . . . . .	1-9
1-6	CORRECT POSITION FOR GIVING COMMANDS . . . . .	1-13

TABLE

1-1	SUGGESTED FOOT TO GIVE MARCHING COMMANDS ON . . . . .	1-16
1-2	DRILL SYMBOLS . . . . .	1-19



# MARINE CORPS DRILL AND CEREMONIES MANUAL

## PART I: DRILL

### CHAPTER 1

#### INTRODUCTION TO DRILL

#### 1000. GENERAL

1. The Marine Corps Drill and Ceremonies Manual is designed to provide uniformity and standardization for all Marine Corps organizations. This Manual prescribes procedures for all close order drill and military ceremonial evolutions. Commanders will only deviate from prescribed procedures when expressly authorized for specific provisions of this Manual. The use of ceremonial drill movements authorized for Marine Barracks, Washington DC are not authorized for any other Marine Corps organization.

2. Online Access. In addition to the information found in this Manual, organizations and individuals may access the Marine Corps Drill web site by linking from Marine LINK at <http://www.usmc.mil/>. This web site not only contains an electronic version of this Manual but also sample LOIs for the various ceremonies described in this Manual.

3. Purpose of Drill. Commanders use drill to:

- a. Move units from one place to another in a standard, orderly manner.
- b. Provide simple formations from which combat formations may be readily assumed.
- c. Teach discipline by instilling habits of precision and automatic response to orders.
- d. Increase the confidence of junior officers and noncommissioned officers through the exercise of command, by the giving of proper commands, and by the control of drilling troops.
- e. Give troops an opportunity to handle individual weapons.

4. Purpose of Formations

- a. To build unit cohesion and esprit de corps by recognizing Marines during awards and promotion ceremonies.
- b. To maintain continuous accountability and control of personnel.
- c. To provide frequent opportunities to observe the appearance and readiness of the uniforms, arms, and equipment of the individual Marine.
- d. To keep the individual Marine informed by providing the means to pass the word.
- e. To develop command presence in unit leaders.
- f. To instill and maintain high standards of military bearing and appearance in units and in the individual Marine.

g. To add color and dignity to the daily routine by reinforcing the traditions of excellence associated with close order drill.

5. Scope. This Manual prescribes drill for general use. Diagrams shown must be adapted to the strength of the unit and available space. Unless otherwise stated, whenever the masculine or feminine gender is used, both men and women are included.

1001. DEFINITIONS. The following definitions are standard terms used throughout this Manual.

1. Alignment. The dressing of several elements on a straight line.
2. Assembly Area. A designated location for forming units of platoon size or larger in preparation for a parade, review or ceremony.
3. Arms. A term used to normally designate the service rifle but can refer to any weapon. When in formation and a mix of weapons is carried the term arms will be used to designate all types of weapons.
4. Base. The element on which a movement is regulated.
5. Cadence. A rhythmic rate of march at a uniform step.
6. Center. The middle element of a formation with an odd number of elements (See figure 1-1a) or the left center element of a formation with an even number of elements. (See figure 1-1b.)

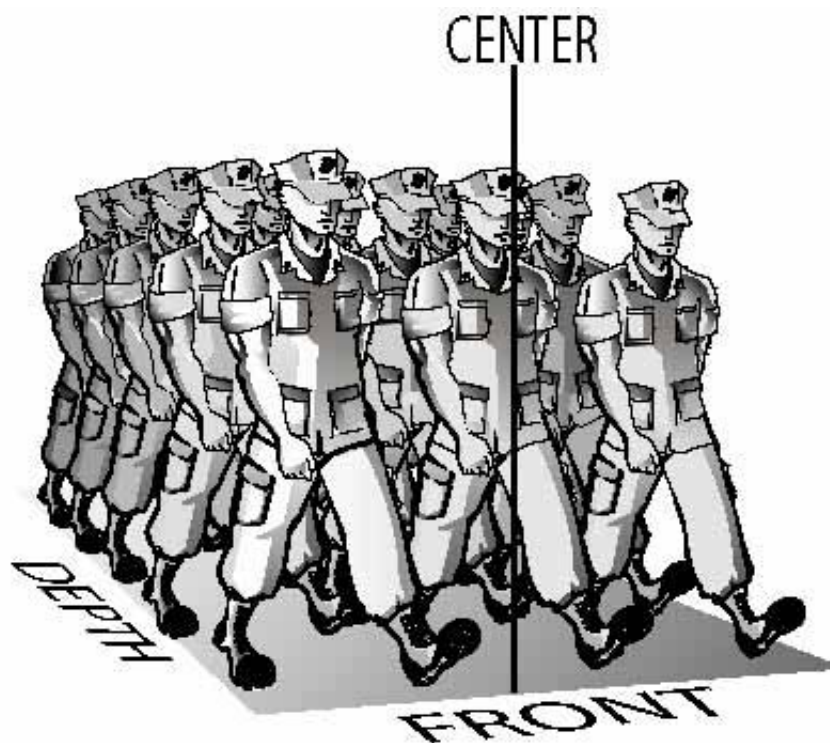

Figure 1-1a.--Center (Odd Number of Elements), Depth, and Front.

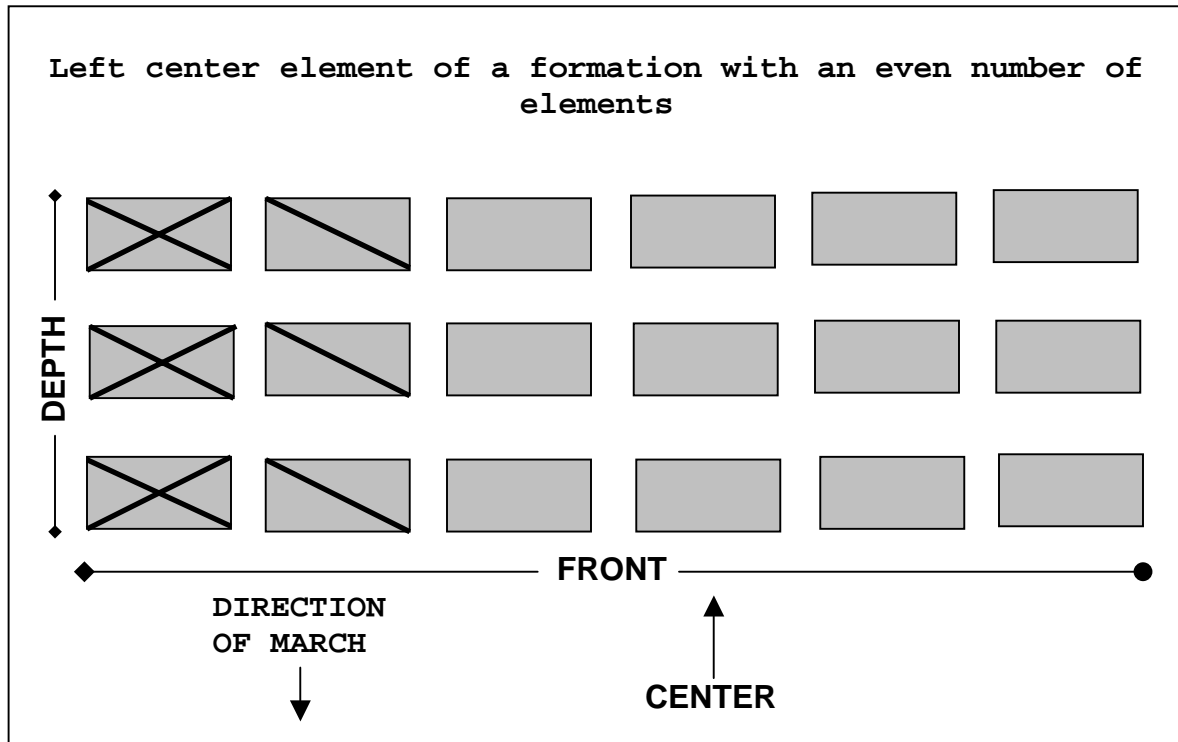

Figure 1-1b.--Center, Even Number of Elements.

7. Ceremony. A formal military formation designated to observe a specific occasion.
8. Column. A formation in which elements are placed one behind the other. A section or platoon is in column when members of each squad are one behind the other with the squads abreast of each other.
9. Commander of Troops (COT). The COT is the senior officer taking part in the ceremony. If an enlisted ceremony the COT is the senior enlisted.
10. Depth. The space from head to rear of an element or a formation. (See figure 1-1a.) The depth of an individual is considered to be 12 inches.
11. Distance. The space between elements in the direction of depth. Between individuals, the space between your chest and the person to your front. Between vehicles, the space between the front end of a vehicle and the rear of the vehicle to its front. Between troops in formation (either on foot, mounted, or in vehicles), the space from the front of the rear unit to the rear of the unit in front. Platoon commanders, guides, and others whose positions in a formation are 40 inches from a rank are, themselves, considered a rank. Otherwise, commanders and those with them are not considered in measuring distance between units. The color guard is not considered in measuring distance between subdivisions of the unit with which it is posted. In troop formations, the distance between ranks is 40 inches. (See figure 1-2.)



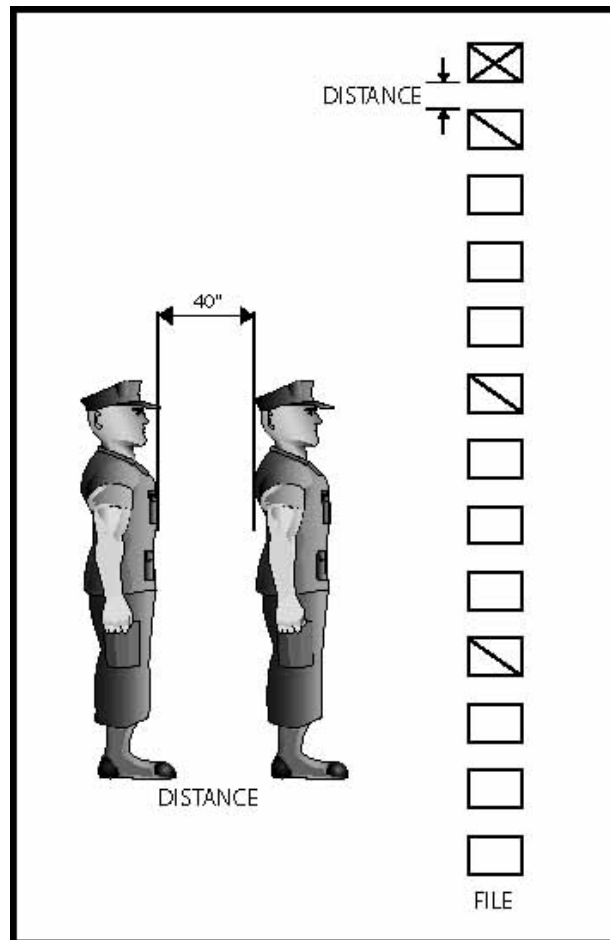

Figure 1-2.--Distance and File.

12. Double Time. Cadence at 180 steps (36 inches in length) per minute.
13. Element. An individual, squad, section, platoon, company, or other unit that is part of a larger unit.
14. Extended Mass Formation. The formation of a company or larger unit in which major elements are in column at close or normal interval and abreast at a specified interval greater than normal interval.
15. File. A single column of troops or vehicles one behind the other.
16. Flank. The right or left extremity of a unit, either in line or in column. The element on the extreme right or left of the line. A direction at a right angle to the direction an element or a formation is facing.
17. Formation. Arrangement of elements of a unit in line, in column, or in any other prescribed manner.
18. Front. The space occupied by an element or a formation, measured from one flank to the other. (See figure 1-1a.) The front of an individual is considered to be 22 inches.

1001

19. Guide. The individual (base) upon whom a formation, or other elements thereof, regulates its march. To guide: to regulate interval, direction, or alignment; to regulate cadence on a base file (right, left, or center).

20. Head. The leading element of a column.

21. Interval. The lateral space between elements on the same line. (See figure 1-3.) Interval is measured between individuals from shoulder to shoulder and between vehicles from hub to hub or track to track. It is measured between elements other than individuals and between formations from flank to flank. Unit commanders and those with them are not considered in measuring interval between elements of the unit. Normal interval between individuals is one arm's length. Close interval is the horizontal distance between shoulder and elbow when the left hand is placed on the left hip.

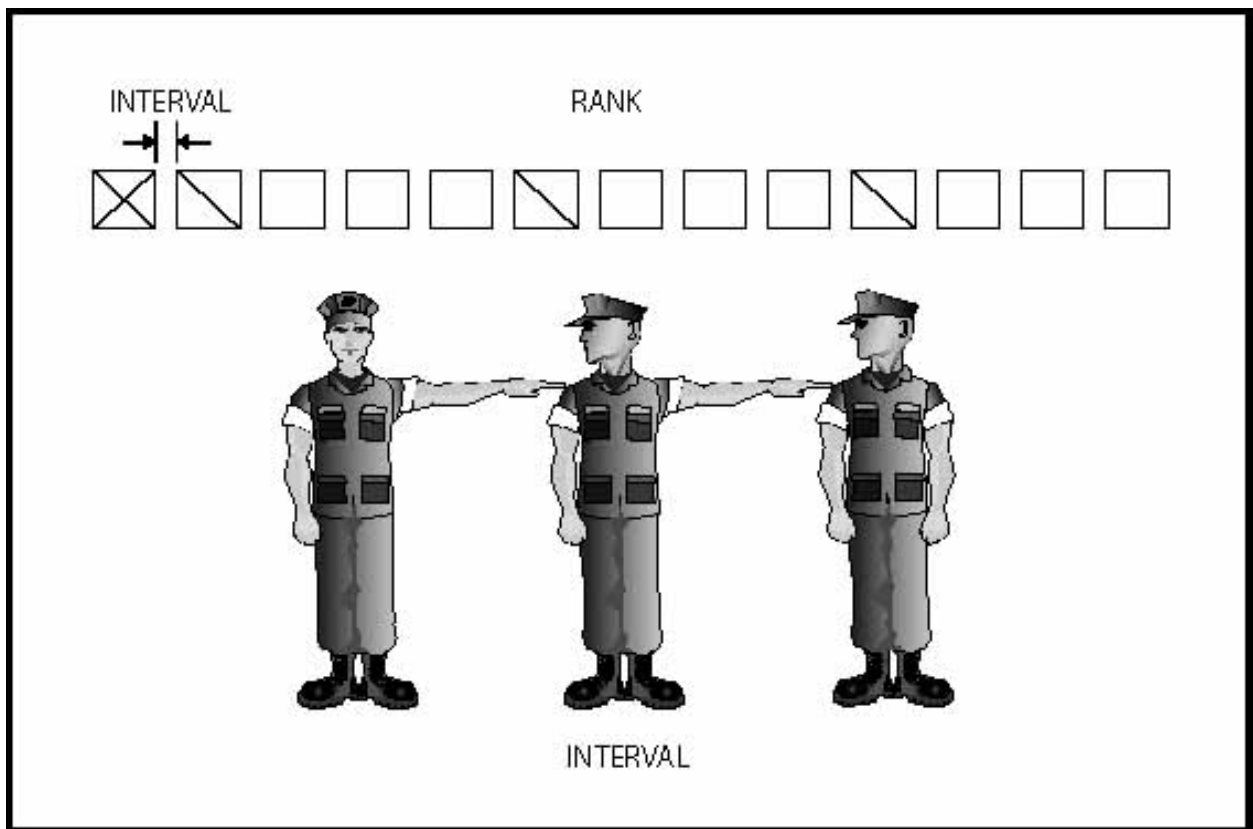

Figure 1-3.--Interval and Rank.

22. Left (Right). Extreme left (right) element or edge of a body of troops.

23. Line. A formation in which the elements are side by side or abreast of each other. A section or platoon is in line when its squads are in line and one behind the other.

24. Line of March. The line on which individuals or units are to march on.

25. Line of Troops. The line on which troops are to form when in formation.

26. Loosened Sling. Indicates a sling adjusted for the movement sling arms.
27. Mass Formation. The formation of a company or larger unit in which the major elements are in column at close interval and abreast at close interval.
28. Muffling. The procedure of draping colors for mourning with a mourning streamer or black bunting. It also refers to the process of muffling the musical instruments of a band for specific types of ceremonies.
29. Pace. The length of a full step in quick time, 30 inches.
30. Parade. A parade is a ceremony that involves the movement of marching units.
31. Parade Sling. A sling that has all excess slack removed and is taught. The keeper is adjusted and locked in a position next to the sling tip. The sling lies on the left side of the rifle.
32. Piece. An individual firearm such as a rifle.
33. Point of Rest. The point toward which all elements of a unit establish their dress or alignment.
34. Quick Time. Cadence at 112 to 120 steps (12, 15, or 30 inches in length) per minute. It is the normal cadence for drills and ceremonies.
35. Rank. A line of troops or vehicles placed side by side.
36. Review. A review is a type of ceremony that omits certain elements found in a parade, but includes an inspection (trooping the line) not found in a parade.
37. Rigged. This term refers to the condition when uniforms and equipment are properly fitted out in the manner for which they were intended for use. Swords are considered rigged when attached to the frog (noncommissioned officers) or sword sling (commissioned officer). A Marine is rigged when wearing the prescribed uniform or equipment.
38. Slow Time. Cadence at 60 steps per minute. Used for funerals only.
39. Snap. In commands or signals, the quality that inspires immediate response. In drill the immediate and smart execution of a movement.
40. Step. The distance from heel to heel between the feet of a marching individual. The half step and back step are 15 inches. The right and left steps are 12 inches. The steps in quick and double time are 30 and 36 inches, respectively.
41. Strong Grip. The strong grip is when the thumb is wrapped around the front of the staff with the fingers wrapped to the rear. (See figure 1-4.)
42. Unit Leader. Is the individual who is drilling the unit. This can be any individual who is conducting drill or can be those assigned a specific billet such as squad leader, platoon sergeant, platoon commander, etc.
43. "V" Grip. The "V" grip is with the staff placed in the "V" formed by the thumbs and forefinger with the fingers extended and joined. (See figure 1-5.)



Figure 1-4.--Strong Grip on the Staff.



Figure 1-5.--"V" Grip on the Staff.

1002. INSTRUCTING DRILL

1. Training personnel in drill is an important duty. From the beginning of their career, officers and noncommissioned officers should take pride in being considered efficient drill instructors. If they know the drill regulations and how to instruct, they will gain the respect and confidence of those they command.
2. In addition, good drill instructors must:
  - a. Follow regulations strictly, as an example to the personnel under instruction.
  - b. Have energy, patience, and spirit.
  - c. Have military neatness and bearing.
  - d. Observe personnel closely, immediately correcting any mistakes noted.
3. When instructing drill movements the system described by the acronym P.C.W.C. will be used to ensure all required information is provided. P.C.W.C. stands for:
  - (P) Purpose of the movement.
  - (C) Number of Counts involved in its execution.
  - (W) When the movement may be executed.
  - (C) Commands to cause the movement to be executed.
4. When instructing drill movements for unit movement the system described by the acronym P.F.W.C will be used to ensure all required information is provided. P.F.W.C. stands for:
  - (P) Purpose of the movement.
  - (F) Formation from which the movement is executed.
  - (W) When the movement may be executed.
  - (C) Commands to cause the movement to be executed.
5. When the instructor corrects a movement, the individual or unit should immediately be required to repeat the movement properly.
6. Before a drill period, an instructor should thoroughly study the movements to be executed.
7. Instructors may place themselves wherever they can best control the troops, make corrections, and ensure proper performance.
8. The instructor briefly explains and demonstrates each new movement prior to its execution by the troops. The troops should take proper positions unassisted. Each position or movement must be thoroughly understood before another is attempted.
9. Drill periods should be short but frequent. Snap should be required in every movement.

1003. INSTRUCTION GROUPS

1. The basic instruction group is the squad. Its size facilitates individual instruction.
2. Individuals who learn slowly should be placed in special squads. The best instructors available should drill these squads.

1004. COMMANDS AND THE COMMAND VOICE

1. There are four types of commands: preparatory commands, commands of execution, combined commands, and supplementary commands. All commands in this Manual are shown in quotation marks, e.g., **"Present, ARMS"** and **bold print**.

a. The preparatory command indicates a movement is to be made and may also indicate the direction of the movement. In this Manual, preparatory commands are shown beginning with a capital letter followed by lower case letters. The comma indicates a pause between the preparatory command and the command of execution. Examples would be **"Forward," "Left," "Platoon," "About,"** etc.

b. The command of execution causes the desired movement to be executed. In this Manual, commands of execution are shown in **CAPITAL LETTERS**. Examples would be **"MARCH," "FACE," "ATTENTION,"** etc.

c. With the combined command, the preparatory command and the command of execution are combined. In this Manual combined commands are shown in **CAPITAL LETTERS**. Examples would be **"AT EASE," "REST," "FALL IN,"** etc.

d. Supplementary commands are commands that cause the component units to act individually. An example would be the commands squad leaders would give to their individual squads following the platoon commander's preparatory command, **"Column of Files From the Right,"** and before the command of execution **"MARCH."** In this Manual supplementary commands may be shown as preparatory commands, commands of execution or combined commands, depending on the movement.

2. When giving commands, commanders face their troops.

a. For company formations or larger, when commanding marching troops from the head of a column or massed formations, commanders march backward while giving commands.

b. When commanding a unit that is part of a larger unit, commanders turn their heads to give commands, but do not face about except when the unit is halted and the smaller units are in line. In this case, the leader faces about to give all commands except to repeat preparatory commands, for which turning the head is sufficient.

3. Commanders of platoons and larger units, when drilling as a part of a still larger unit, repeat all preparatory commands or give the proper new command or warning. There are three exceptions to this.

a. The first is that no repetition is necessary for combined commands such as **"FALL IN," "FALL OUT," "REST,"** or **"AT EASE."**

b. The second is that no repetition of command is necessary when a unit is in mass formation.

c. The third exception is that no repetition of command is necessary during parades and ceremonies where the commander of troops, adjutant, etc., may be clearly heard by all hands or the commander of troops and adjutant, give combined commands and subordinate unit commanders cause their units to execute the command independently. (e.g., when the regimental commander gives the combined command to **"PORT ARMS"** subordinate battalion commanders would give the command of **"Port, ARMS"** so that their battalion would execute the command as an independent unit of the regiment.)

4. If at a halt, the commands for movements, which involve marching at quick time in a direction other than to the direct front, such as **"Column Right, MARCH,"** are not prefaced by the preparatory command, **"Forward."**

5. The only commands that use unit designations, such as "Battalion" or "Company," as preparatory commands are **"ATTENTION"** and **"HALT."** Such commands shall have no further designation added (e.g., "First Battalion, ATTENTION" or "Company C, HALT"). Commands shall be given only as stated herein.

6. A command must be given loud enough to be heard by all members of a unit.

a. Good posture, proper breathing, and the correct use of throat and mouth muscles help develop a commander's voice.

b. Projecting the voice enables one to be heard at maximum range without undue strain. To project a command, commanders must focus their voices on the most distant individuals. Good exercises for voice projection are:

(1) Yawning to get the feel of the open mouth and throat.

(2) Counting and saying the vowel sounds "oh" and "ah" in a full, firm voice.

(3) Giving commands at a uniform cadence, prolonging each syllable.

(4) When practicing, stand erect, breathe properly, keep the mouth open wide, and relax the throat.

c. The diaphragm is the most important muscle in breathing. It is the large horizontal muscle that separates the chest from the abdomen. It automatically controls normal breathing, but must be developed to give commands properly. Deep breathing exercises are one good method of developing the diaphragm. Another is to take a deep breath, hold it, open the mouth, relax the throat muscles, and snap out a series of fast "hats" or "huts." Expelling short puffs of air from the lungs should make these sounds. If properly done, you can feel the stomach muscles tighten as the sounds are made.

d. The throat, mouth, and nose act as amplifiers. They give fullness to and help project the voice. In giving commands, the throat should be relaxed. The lower jaw and lips should be loose. The mouth should be open wide and the vowel sounds (a, e, i, o, u) should be prolonged. Consonants (letters other than vowels) and word endings should be curt and sharply cut off.

e. The position of attention is the proper position for giving commands (See figure 1-6a). A leader's bearing will be emulated. If it is military, junior personnel will be inspired to respond to commands with snap and precision.

f. Distinct commands inspire troops. Indistinct commands confuse them. All commands can be given correctly without loss of effect or cadence. To give distinct commands, you must emphasize enunciation; make full use of the tongue, lips, and lower jaw; practice giving commands slowly, carefully, and in cadence; and then increase the rate of delivery until the proper rhythm (112 to 120 beats per minute) is reached and each syllable is distinct. Raising the hand to the mouth to aid in projecting commands is not proper.

g. Inflection is the rise and fall in pitch, the tone changes of the voice.

(1) Preparatory commands should be delivered with a rise and inflection in the voice. (e.g., "BaaaTAL ion," "PlaaaTOON," "FooreWARD," "TO the REAR," etc.) In particular those preparatory commands that cause supplemental movements should be heavily accentuated on the last syllable. (e.g., The command "**Present, ARMS**" the preparatory command Preee(pause) ZENT" causes those armed with swords to execute the first count of the movement and the national color to go to the carry. Another example is "**Officers, Center, MARCH.**" On the preparatory command of "OfficERS" those armed with swords go to the carry, on the preparatory command of "CennnTER" the officer's step and/or face)

(2) A command of execution is given in a sharper and higher pitch than the tone of the preparatory command's last syllable. A good command of execution has no inflection, but it must have snap. It should be delivered with sharp emphasis, ending like the crack of a whip. If properly given, troops will react to it with snap and precision.

(3) Combined commands such as "**FALL IN**" are delivered without inflection. They are given in the uniform high pitch and loudness of a command of execution.



a. Position of Attention.



b. Right Shoulder Arms.

Figure 1-6.--Correct Position for Giving Commands.



1005. GENERAL RULES FOR DRILL

1. Certain drill movements may be made toward either flank. This Manual explains such movements in one direction only. To move to the other direction, it is necessary to substitute the word "left" for "right" as shown in parentheses.
2. The command, "AS YOU WERE," cancels a movement or order started but not completed. At this command, troops should resume their former positions.
3. While marching, alignment is maintained toward the right, except:
  - a. Upon the command "GUIDE LEFT" or "GUIDE CENTER," alignment is maintained toward the left or center until the command "GUIDE RIGHT" is given.
  - b. Regardless of the direction in which alignment is established, at the command of execution for a drill movement involving marching, the direction of alignment is toward direction of the movement. (e.g., if the command of "Column Left, MARCH" is given, the unit aligns to the left until the column movement is completed.) Upon completion of the drill movement, alignment will be in the direction established prior to commencing the movement.
  - c. In a column of platoons, the guide of the leading platoon controls direction and distance, and maintains the cadence counted by the commander. Guides of the following platoons control distances and follow the direction and cadence set by the leading guide.
4. Slight changes in direction are made by:
  - a. Adding "Half" to the preparatory command for turning or column movements; for example, "Column Half Right (Left), MARCH," changes direction 45 degrees.
  - b. At the command "INCLINE TO THE RIGHT (LEFT)," guides change their direction of march slightly to the right (left).
5. Platoons in a company and individuals in a squad are numbered from right to left in line, and from front to rear in column. Squads in a platoon are numbered from front to rear in line and from left to right in column.
6. Posts of officers, noncommissioned officers, guidon bearers, and special units are shown in figures or explained later in this Manual.
  - a. Changes of post are made by the most direct route unless specifically prescribed. The movement is made as soon as possible after the command of execution. Persons who have duties in connection with the movement take their new posts after those duties have been performed. Individuals moving from one post to another or aligning units must maintain military bearing. All necessary facings and changes of direction must be made as if drilling.
  - b. After the initial formation, guidon bearers and special units maintain their positions with respect to the flank or end of the organization with which they were originally posted.
  - c. All officers or noncommissioned officers commanding armed troops will be armed. When giving commands, drilling troops, or making reports, the rifle will be carried at right shoulder arms (See figure 1-6b), the sword will be carried at the

carry sword position, and the pistol will be carried in the holster. Facing movements by commanders of armed troops may be executed while at right shoulder arms.

7. Whenever drill movements are executed while troops are marching, the command of execution is given as the left foot strikes the deck if the movement is to the left, and as the right foot strikes the deck if the movement is to the right. The one exception is when executing left shoulder arms from port arms; the command of execution will be given on the right foot. (See table 1-1 for the suggested foot to give commands on while marching.)

8. The cadence of commands should be that of quick time, even though no marching is involved. The pause between preparatory commands and commands of execution should be adapted to the size and formation of the unit.

a. The best pause to allow for a squad or platoon while marching is one count or step between the two commands. (See table 1-1 for the suggested foot to give commands on while marching.)

(1) To develop the proper cadence for commands at a halt, count ONE, TWO, THREE, FOUR in quick time. Then give commands, such as **"Right, FACE,"** without interrupting the cadence:

ONE	TWO	THREE	FOUR
<b>"Right,</b>	(Pause)	<b>FACE"</b>	

(2) Marching commands, such as **"By the Right Flank, MARCH,"** must be started so the preparatory command will end as the foot in the desired direction of movement strikes the deck. There is then a full count before the command of execution, which is given on the same foot. (See table 1-1 for the suggested foot to give commands on while marching.)

b. For a company or larger unit, the intervals must be longer. This is necessary for leaders of component units to repeat preparatory commands, give warning, or supplementary commands. The following example shows the proper cadence for the command **"Right, FACE"** to a company:

ONE	TWO	THREE	FOUR
(Company Commander)	(Platoon Commander)		(Company Commander)
<b>"Right,</b>	{ <b>"Right"</b> }		<b>FACE"</b>

#### 1006. DRILL BY THE NUMBERS

1. Drill movements may be divided into individual motions for instruction. When drill is executed by the numbers, the first motion is made on the command of execution. Subsequent motions are made in proper order on the commands TWO, THREE, FOUR, the number of counts depending upon the number of motions in the movement. To use this method, the command **"BY THE NUMBERS"** precedes the preparatory command. All movements are then executed by the numbers until the command **"WITHOUT NUMBERS"** is given.

RIGHT	LEFT	RIGHT	LEFT	RIGHT	LEFT	WHEN GIVEN
		"Squad,	(Step)	HALT"		From column or flank
	"Pla	toon,	(Step)	HALT"		From column or flank
	"Com pa ney		(Step)	HALT"		From column or flank
	"Right	Turn,	(Step)	MARCH"		While marching in company mass the color guard or staff
"Left	Turn,	(Step)	MARCH"			" " " " " " " "
"Counter	March,	(Step)	MARCH"			For color guards.
"Mark	Time,	(Step)	MARCH"			May be given as either foot strikes the deck from line, column or oblique
	"Mark	Time,	(Step)	MARCH"		
"Half	Step,	(Step)	MARCH"			May be given as either foot strikes the deck from line, column or oblique
	"Half	Step,	(Step)	MARCH"		
"For	ward,	(Step)	MARCH"			From mark time or half step in column or flank
"By Right	the	Flank,	(Step)	MARCH"		From column or flank
	"By Left	the	Flank,	(Step)	MARCH"	From column or flank
RIGHT	LEFT	RIGHT	LEFT	RIGHT	LEFT	WHEN GIVEN
	"Column	Right,	(Step)	MARCH"		From column
"Column	Left,	(Step)	MARCH"			From column
"Column	Half	Right,	(Step)	MARCH"		From column
	"Column	Half	Left,	(Step)	MARCH"	From column
	"To Rear,	the	(Step)	MARCH"		From column or flank
	"Right blique,	O	(Step)	MARCH"		From column
"For	ward,	(Step)	MARCH"			From right oblique
"Pla	toon,	(Step)	HALT"			From right oblique
	"In	Place,	(Step)	HALT"		To halt in the right oblique while marching at quick time, mark time or half step.
"Re	sume,	(Step)	MARCH"			To resume marching in the left/right oblique from in place halt, mark time or half step
"Left blique,	O	(Step)	MARCH"			From column
	"For	ward,	(Step)	MARCH"		From left oblique
	"Pla	toon,	(Step)	HALT"		From left oblique
	"In	Place,	(Step)	HALT"		To halt in the left oblique while marching at quick time, mark time or half step.

Table 1-1.--Suggested Foot to Give Marching Commands On.

RIGHT	LEFT	RIGHT	LEFT	RIGHT	LEFT	WHEN GIVEN
"Close,	(Step)	MARCH"				To close the interval in column marching
"Ex	tend,	(Step)	MARCH"			To extend the interval in column marching
"Count	Cad	ence,	(Step)	COUNT"		From column
"De	lay	Cad	ence,	(Step)	COUNT"	From column
ed						
COMMANDS FOR THE MANUAL OF ARMS WHILE MARCHING						
"Port,	(Step)	ARMS"				From left shoulder
"Left	Shoul	der,	(Step)	ARMS"		From port arms
	"Left	Shoul	der,	(Step)	ARMS"	From right shoulder
"Right	Shoul	der,	(Step)	ARMS"		From left shoulder or port
	"Port,	(Step)	ARMS"			From right shoulder
RIGHT	LEFT	RIGHT	LEFT	RIGHT	LEFT	WHEN GIVEN

Table 1-1.--Suggested Foot to Give Marching Commands On--Continued.

1007. MASS COMMANDS AND INDIVIDUAL COMMANDS FROM RANKS

1. Mass Commands. The use of mass commands in drill develops confidence and team spirit. It also teaches troops to give and execute commands properly.

a. The initial command is **"At Your Command."** The instructor then gives a preparatory command that describes the movement, for example, **"At Your Command, Face the Platoon to the Right, COMMAND."** After this, all members of the platoon command, **"Right, FACE"** together and execute it. Another mass command example is **"At Your Command, Call the Platoon to Attention, COMMAND."** The troops command, **"Platoon, ATTENTION."**

b. Marching movements may be conducted in a similar manner as follows: **"ALL MOVEMENTS UNTIL FURTHER NOTICE WILL BE AT YOUR COMMAND."**

(1) INSTRUCTOR: **"Call the Platoon to Attention, COMMAND."** TROOPS: **"Platoon, ATTENTION."**

(2) INSTRUCTOR: **"Forward, COMMAND."** TROOPS: **"Forward, MARCH."**

(3) INSTRUCTOR: **"By the Right Flank, COMMAND."** TROOPS: **"By the Right Flank, MARCH."**

c. Only simple movements with short preparatory commands are used for mass commands. Preparatory commands that require supplemental commands by subordinate leaders are not used.

d. In order to return to normal drill methods, the instructor orders **"At My Command."**

2. Individual Commands From Ranks. As an aid in training individuals to give commands properly, personnel in ranks may be designated to give individual commands. This should be done only after a unit has learned to execute commands and give mass commands. The instructor designates the individual who is to give the command by name or place in ranks. He may be designated while the unit is

marching or halted. The instructor describes the movement to be made, as in mass commands, but does not add **"COMMAND."** The designated individual remains in position and gives the appropriate command, executing the command with the unit.

3. Counting Cadence. Counting cadence by troops in ranks teaches them group coordination and rhythm. The command is **"Count Cadence, COUNT"** or **"Delayed Cadence, COUNT."** The command of execution being given as the left foot hits the deck. Everyone then counts cadence for 8 steps, starting when the left foot next strikes the deck. They should be required to do so in a firm, vigorous manner.

<b>"Count Cadence, COUNT"</b>								
Step	LEFT	RIGHT	LEFT	RIGHT	LEFT	RIGHT	LEFT	RIGHT
Count	One	Two	Three	Four	One	Two	Three	Four

<b>"Delayed Cadence, COUNT"</b>										
Step	LEFT	RIGHT	LEFT	RIGHT	LEFT	RIGHT	LEFT	RIGHT	LEFT	RIGHT
Count	One		Two		Three		Four		One	
	Two		Three		Four		One	Two	Three	Four
	One	Two	Three	Four	(United)	(States)	(Marine)	(Corps)		

#### 1008. ADVANCED DRILL PROCEDURES

1. Cadence Drill (Speed Drill). Cadence drill is an advanced form of drill. It is used only with Marines who have learned basic drill as prescribed in this Manual. It provides variety for well-trained troops and "liven up" a drill period. In cadence drill, the commander, abbreviates preparatory commands and deletes the pause between the preparatory command and the command of execution. Each time a commander uses this form of drill, he must explain that the unit is departing from prescribed drill. Cadence drill is suitable for platoon and smaller units. Examples of cadence drill are:

Count One	Two	Three	Four	One
Step	LEFT	RIGHT	LEFT	RIGHT
Command (s)	<b>"Left</b>	<b>Flank</b>	<b>Flank</b>	<b>MARCH"</b>
	<b>"Rear</b>	<b>MARCH"</b>		

2. Trick Drill. As with cadence drill, this form of drill is used only with troops who have thoroughly learned all prescribed drill and cadence drill. Additionally, it may be used as a motivating device for well-trained troops. It is extremely complex and requires extensive training and rehearsals. Trick drills are not described in this Manual. They are limited only by the imagination of the drill instructor.

#### 1009. TABLE OF SYMBOLS USED IN THIS MANUAL

1. Table 1-2 shows the symbols used in this Manual.

























	Reviewing Officer				First Sergeant
	Regimental Commander	DIRECTION OF MARCH			Sergeant Major
	Battalion Commander	DIRECTION FACING			Gunnery Sergeant
	Commander of Troops (COT)		Color Guard		Platoon Sergeant
	Commander's Staff		Company Guide		Platoon Guide
	Adjutant		Band or Music		Squad Leader
	Company Commander		Dress Guidon		Section Leader
	Company XO		Field Marker		Fire Team Leader
	Platoon Commander				Rifleman
					File Closer

Table 1-2.--Drill Symbols.

MARINE CORPS DRILL AND CEREMONIES MANUAL

PART I: DRILL

CHAPTER 2

INDIVIDUAL INSTRUCTIONS WITHOUT ARMS

	<u>PARAGRAPH</u>	<u>PAGE</u>
GENERAL . . . . .	2000	2-3
SECTION 1: POSITIONS		
ATTENTION . . . . .	2100	2-5
REST . . . . .	2101	2-6
EYES RIGHT (LEFT) . . . . .	2102	2-7
FACING MOVEMENTS . . . . .	2103	2-8
HAND SALUTES . . . . .	2104	2-9
SECTION 2: STEPS AND MARCHING		
GENERAL . . . . .	2200	2-11
QUICK TIME . . . . .	2201	2-11
DOUBLE TIME . . . . .	2202	2-11
HALT . . . . .	2203	2-12
MARK TIME . . . . .	2204	2-13
DOUBLE TIME IN PLACE . . . . .	2205	2-13
HALF STEP . . . . .	2206	2-14
SIDE STEP . . . . .	2207	2-14
BACK STEP . . . . .	2208	2-14
TO FACE TO THE RIGHT (LEFT) IN MARCHING . . . . .	2209	2-15
TO FACE TO THE REAR WHILE MARCHING . . . . .	2210	2-15
TO MARCH TO THE FLANK . . . . .	2211	2-16
TO CHANGE STEP . . . . .	2212	2-17
TO MARCH AT EASE . . . . .	2213	2-17
TO MARCH AT ROUTE STEP . . . . .	2214	2-17
TO RESUME MARCHING AT QUICK TIME FROM ROUTE STEP OR AT EASE . . . . .	2215	2-17

MARINE CORPS DRILL AND CEREMONIES MANUAL+

	<u>PAGE</u>
	FIGURE
2-1 POSITION OF ATTENTION . . . . .	2-6
2-2 POSITION OF PARADE REST . . . . .	2-7
2-3 RIGHT FACE . . . . .	2-8
2-5 ABOUT FACE . . . . .	2-9
2-6 HAND SALUTE . . . . .	2-10



MARINE CORPS DRILL AND CEREMONIES MANUAL

PART I: DRILL

CHAPTER 2

INDIVIDUAL INSTRUCTIONS WITHOUT ARMS

2000. GENERAL

1. Individual movements form the basis for building unit formations and movements.
2. Movements that can be executed from both the halt and while on the march should be explained, demonstrated, and practiced from the halt first.



SECTION 1: POSITIONS

2100. ATTENTION. The position of attention (see figure 2-1) is the basic military position from which most other drill movements are executed. There are no counts, however, there are seven steps in describing the position:

1. Smartly bring your left heel against the right.
2. Turn your feet out equally to form an angle of 45 degrees. Keep your heels on the same line and touching.
3. Your legs should be straight, but not stiff at the knees.
4. Keep your hips and shoulders level and your chest lifted.
5. Your arms should be straight, but not stiff at the elbows; thumbs along the trouser seams, palms facing inward toward your legs, and fingers joined in their natural curl.
6. Keep your head and body erect. Look straight ahead. Keep your mouth closed and your chin pulled in slightly.
7. Stand still and do not talk.
8. The movement may be executed when halted, at any position of rest, or while marching at route step or at ease. The commands are "FALL IN" and "ATTENTION." On the command "FALL IN," you would assume your position in ranks at the position of attention. The command "ATTENTION" is always preceded by a preparatory command designated by the size of the unit, such as "Squad, Platoon," or "Company." For example, when drilling a squad the command to bring them to attention would be "Squad, ATTENTION." Thereafter, they move only as ordered until given "AT EASE," "REST," "FALL OUT," or they are dismissed.
9. When at a position of rest or while marching at route step or at ease and the command "ATTENTION" is given, the following applies:
  - a. When given at parade rest, come to attention.
  - b. When given at ease or rest, assume the position of parade rest on the preparatory command "Squad." When "ATTENTION" is given go to that position.
  - c. When given while marching at route step or at ease, get in step as soon as possible and continue to march at attention.



a. Front View.

b. Side View.

c. Rear View.

Figure 2-1.--Position of Attention.

2101. REST. There are four positions of rest for halted troops. They are parade rest, at ease, rest, and fall out. The purpose of rest is to give troops a rest from the position of attention. Parade rest, at ease, and rest, are one-count movements. Fall out is not a precision movement and has no counts. All are executed from the position of attention. The commands are "**Parade, REST;**" "**AT EASE;**" "**REST;**" and "**FALL OUT.**"

1. Parade Rest. On the preparatory command "**Parade,**" shift the weight of your body to the right leg without noticeable movement. On the command of execution "**REST,**" and for the count of one, move the left foot twelve inches (measured from the inside of each heel) smartly to the left. The heels remain on line and the body weight rests equally on both legs. At the same time the left foot is moved, clasp the hands behind the back. The left hand is placed just below the belt and the right hand is placed inside the left. The thumb of the right hand lightly grasps the thumb of the left. All fingers are extended and joined with the palms to the rear. The elbows will be in line with the body. Silence and immobility are required. (See figure 2-2.) The only command you may receive while at parade rest is "**ATTENTION.**"

2. At Ease. The command is "**AT EASE.**" It is executed in one count. At the command, keep your right foot in place. You may move about, but must not talk. You may also be given this command when not in ranks. In this case, it means cease talking, but continue whatever you were doing before the command. When in ranks, the only command you may receive while at ease is "**ATTENTION.**"

3. Rest. The command is "**REST.**" It is executed in one count. At the command, you may move and talk; however, you must keep your right foot in place. The only command you may receive while at rest is "**ATTENTION.**"

4. Fall Out. The command is "**FALL OUT.**" At the command, leave your position in ranks, but remain nearby or proceed to a pre-designated area. When "**FALL IN**" is given, return to your place in ranks at the position of attention.

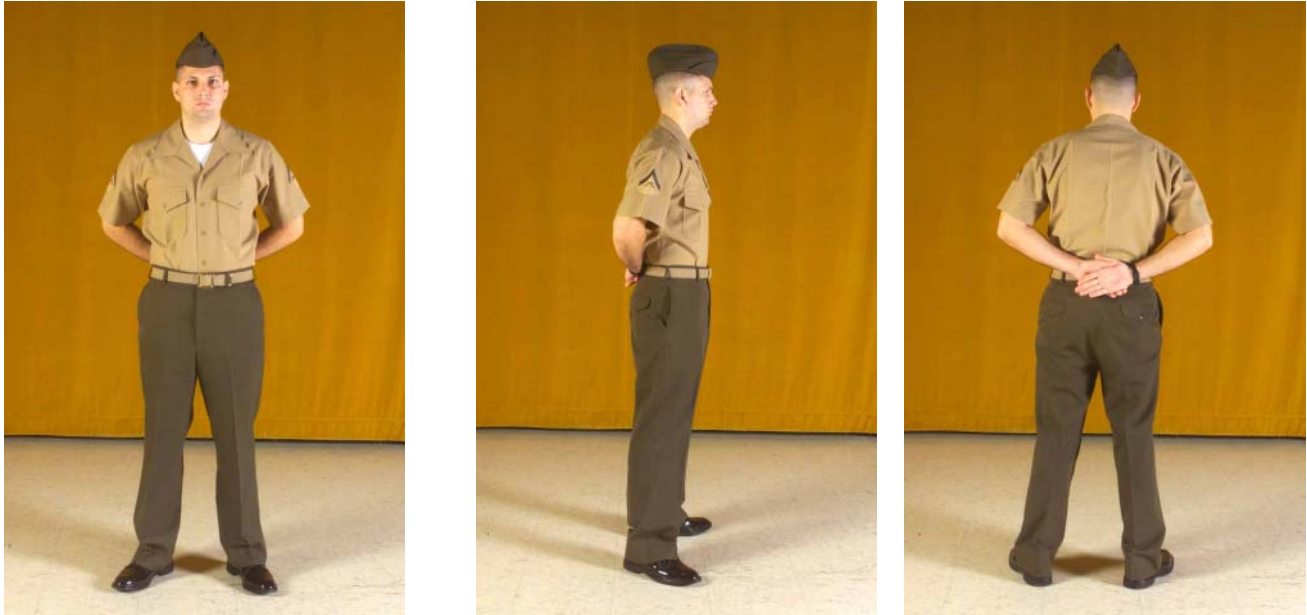

a. Front View.

b. Side View.

c. Rear View.

Figure 2-2.--Position of Parade Rest.

2102. EYES RIGHT (LEFT). The purpose of eyes right (left) is to demonstrate military courtesy to reviewing officers and dignitaries during parades and ceremonies. It is executed in one count when halted at attention or marching at quick time. The command is "**Eyes, RIGHT (LEFT).**" The command to turn the head back to the position of attention is "**Ready, FRONT.**"

1. When the command of execution "**RIGHT (LEFT)**" is given, turn your head smartly and look 45 degrees to the right (left) keeping your shoulders square to the front.
2. On the command of execution "**FRONT,**" turn your head and eyes smartly back to the front. During reviews at which the reviewing officer troops the line, ready front will not be given after eyes right. At such ceremonies, turn your head and eyes smartly toward the reviewing officer upon the command of execution "**RIGHT.**" As he passes to the left, follow the reviewing officer with your head and eyes until you are looking directly to the front.
3. When marching, give the command, "**Eyes, RIGHT**" so that the command of execution is given as the right foot strikes the deck and the command "**Eyes, LEFT**" so that the command of execution is given as the left foot strikes the deck. Give the command "**Ready, FRONT**" from eyes right so that the command of execution is given as the left foot strikes the deck and "**Ready, FRONT**" from eyes left so that the command of execution is given as the right foot strikes the deck. For example:

<u>LEFT</u>	<u>RIGHT</u>	<u>LEFT</u>	<u>RIGHT</u>
"Ready,	"Eyes,	(Step)	<b>RIGHT"</b>
	(Step)	<b>FRONT"</b> (From " <b>Eyes, RIGHT</b> ")	
"Eyes,	(Step)	<b>LEFT"</b>	
	"Ready,	(Step)	<b>FRONT"</b> (From " <b>Eyes, LEFT</b> ")

2103. **FACING MOMENTS.** The purpose of facing movements is to face a unit to the right, left or about. Facing movements are executed in two counts when halted at attention. The commands are **"Right, FACE;"** **"Left, FACE;"** and **"About, FACE."** Facing movements are executed in the cadence of quick time. While facing, your arms should not swing out from your sides, but remain at the position of attention.

1. **"Right, FACE"** is a two-count movement. (See figure 2-3.)

a. On count one, (see figure 2-3b) at the command **"FACE,"** raise your left heel and right toe slightly. Turn to the right on your right heel and left toe. Keep your left leg straight but not stiff.

b. On count two (see figure 2-3c), place the left foot smartly beside the right and stand at attention.

2. **"Left, FACE"** is executed in the same manner described in 2103.1 above, substituting left for right and right for left.



a. Start.

b. Count One.

c. Count Two.

Figure 2-3.--Right Face.

3. **"About, FACE"** is a two-count movement. (See figure 2-5.)

a. At the command **"About,"** shift your weight to your left leg without noticeable movement. (See figure 2-5a.)

b. On count one (see figure 2-5b) at the command **"FACE,"** place our right toe half a foot length behind and slightly to the left of your heel. Do not change the position of your left foot. Rest your weight evenly on the left heel and the ball of the right foot.

c. On count two (see figure 2-5c), turn smartly to the right until facing rear. The turn is made on the left heel and ball of the right foot. The knees remain straight, but not locked during the movement. Your thumbs will remain on the seams of your trousers. If properly executed you will be at the position of attention facing in the opposite direction.



a. Count One.



b. Count Two.



c. Finish.

Figure 2-5.--About Face.

#### 2104. HAND SALUTES

1. The purpose of the hand salute is to demonstrate mutual respect and courtesy between members of military organizations and to show respect to national colors. It is executed in one count when halted at attention, marching at quick time, or seated in a vehicle. The command is "**Hand, SALUTE.**" To return to the position of attention the command is "**Ready, TWO.**"

a. When "**SALUTE**" is given, raise your right hand smartly in the most direct manner until the tip of your forefinger touches the lower part of the headdress above and slightly right of your right eye. Your fingers should be extended straight and joined with the thumb along the forefinger. You should be able to see your entire palm when looking straight ahead. Your upper arm should be parallel with the deck with the elbow in line with the body and your forearm at a 45-degree angle. Your wrist and hand should be straight, a continuation of the line made by your forearm. At the same time, if not in ranks, turn your head and eyes toward the person or colors you are saluting.

b. At the command "**TWO,**" return to attention. Move your hand smartly in the most direct manner back to its normal position by your side.

c. To ensure simultaneous execution of the second movement of the hand salute when troops are in formation, the preparatory command "**Ready,**" will be used prior to the command of execution "**TWO.**"

2. You may salute without command from attention, while walking, or while seated in a vehicle. When walking, it is not necessary to halt to salute. Keep walking, but at attention. The salute is rendered when the person or colors to be saluted is at a 6-pace distance, or at the nearest point of approach if it is apparent that the person or color is not going to approach within 6 paces. The salute will not be rendered if the person (color) to be saluted does not approach within 30 paces.

Hold the first position of the salute until the person (color) saluted has passed or the salute is returned, then execute the second movement of the hand salute.

3. When the command "**Present, ARMS**" is given, if not armed, you execute the hand salute on the command "**ARMS.**" Stay at that position until the command "**Ready, TWO**" or "**Order, ARMS**" is given.

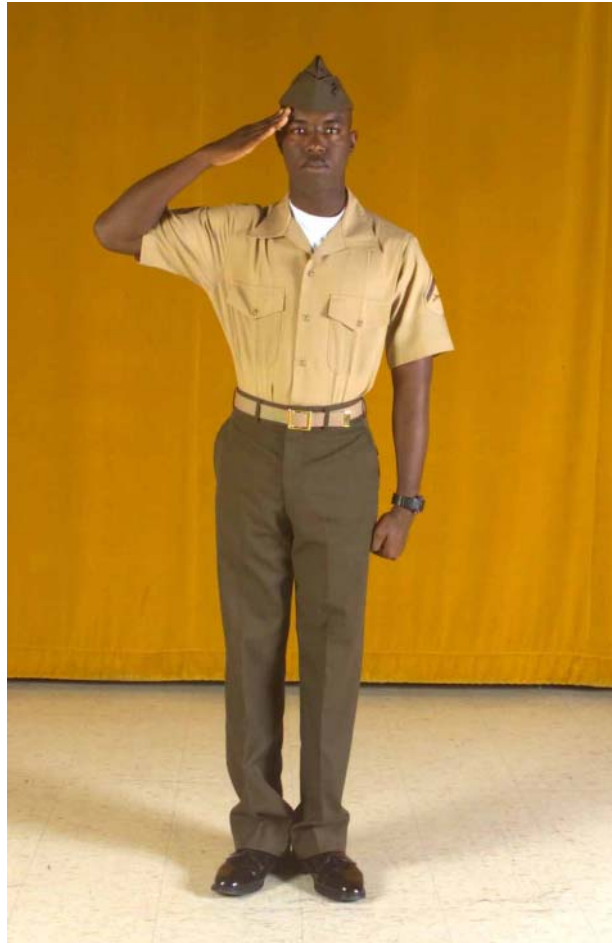

Figure 2-6.--Hand Salute.



2202

## SECTION 2: STEPS AND MARCHING

2200. GENERAL

1. With the exception of right step, all steps and marching movements beginning from a halt start with the left foot.
2. The instructor indicates the proper rhythm by counting cadence.
3. To change direction on the march, the command of execution is given as the foot in the desired direction of the turn strikes the deck.

2201. QUICK TIME. The purpose of quick time is to march at 112 to 120 steps per minute taking 30-inch steps. It may be executed when halted at attention, marking time, marching forward at double time, or marching at half step. The commands are **"Forward, MARCH"** or **"Quick Time, MARCH."**

1. When halted, the command to march forward at quick time is **"Forward, MARCH."**
2. On **"Forward,"** shift your weight to the right leg without noticeable movement.
3. On **"MARCH,"** step off smartly, left foot first, and march straight ahead with 30-inch steps. Swing your arms easily in their natural arcs, 6 inches straight to the front and 3 inches to the rear. Do not exaggerate movements.

2202. DOUBLE TIME. The purpose of double time is to march at 180 steps per minute taking 36-inch steps. It may be executed when halted at attention, marking time, double timing in place, or marching forward at quick time. The command is **"Double Time, MARCH."** When given while marching, the command **"MARCH"** may be given as either foot strikes the deck.

1. When Halted

- a. At the command **"Double Time,"** shift your weight to your right leg without noticeable movement.
- b. On **"MARCH,"** step off on the left foot and begin an easy run, taking 180, 36-inch steps per minute. At the same time raise your forearms until parallel with the deck and make fists of your hands.

2. When Marching at Quick Time

- a. When the command **"MARCH"** is given, take one more 30-inch step.
  - b. Step off in double time.
3. To Resume Quick Time, the Command is "Quick Time, MARCH"
- a. On **"MARCH,"** take one more 36-inch step.
  - b. Lower your arms and slow to quick time.

#### 4. When Marching in Place

- a. Take one more step in mark time (or double time in place).
- b. Step off forward in double time.

2203. HALT. The purpose of halt is to stop the movement of a marching unit. It is executed in two counts when marching at quick time, and three counts when marching at double time. It may be executed when marching at quick time, half step, double time, side step, back step, mark time, and double time in place. The command of execution is "**HALT**," which is always preceded by a preparatory command designated by the size of the unit, such as "**Squad, Platoon**," or "**Company**." The command of execution may be given as either foot strikes the deck except for side step.

#### 1. While Marching at Quick Time or Half Step

- a. Take one more step after "**HALT**."
- b. Bring the rear heel forward against the other.

#### 2. While Marching at Double Time

- a. Take one more double time step after "**HALT**."
- b. Take another at quick time.
- c. Bring the rear heel forward against the other.

#### 3. While Marching at Right (Left) Step

- a. The command "**HALT**" is given when the heels are together.
- b. Take one more side step after "**HALT**."
- c. Bring the heels together.

#### 4. While Backward Marching

- a. Take one more back step after "**HALT**."
- b. Bring the forward heel back against the other.

#### 5. While Marching at Mark Time

- a. Take one more step in place after the command "**HALT**."
- b. Bring the heels together.

#### 6. While Marching at in Place Double Time

- a. Take one more in place double time step after the command "**HALT**."
- b. Take another at quick time.
- c. Bring the heels together.

2204. MARK TIME. The purpose of mark time is to march in place at quick time cadence. It may be executed when halted at attention, double timing in place, marching at half step and marching forward at quick time. While marching, the command may be given as either foot strikes the deck. The command is **"Mark Time, MARCH."**

1. When Halted

a. On the command **"Mark Time,"** shift your weight to your right leg slightly without noticeable movement.

b. On the command **"MARCH,"** beginning with your left foot, then alternating, raise each foot so that the ball of the foot is approximately 2 inches and the heel approximately 4 inches from the deck at a cadence of quick time. At the same time, swing your arms naturally as in marching.

2. When Marching at Quick Time

a. On the command **"MARCH,"** take one more 30-inch step as if coming to a halt.

b. Bring your heels together. Begin marking time without loss of cadence with the opposite foot.

3. To Resume the March at Quick Time, The Command is "Forward, MARCH"

a. On the command **"MARCH,"** take one more step in place.

b. Step off with a 30-inch step.

4. When Marching at Double Time in Place

a. On the command **"MARCH,"** take one more step in place at double time.

b. Commence marking time.

2205. DOUBLE TIME IN PLACE. The purpose of double time in place is to march in place at double time cadence. It may be executed when halted at attention, marking time, or marching forward at double time. The command is **"In Place Double Time, MARCH."**

1. When Halted

a. On the command **"In Place Double Time,"** shift your weight to your right leg without noticeable movement.

b. On the command **"MARCH,"** raise your arms for double time. Starting with the left foot, alternating and in place, raise your feet 6 inches above the deck at 180 steps per minute.

2. When Marching at Double Time

a. After **"MARCH,"** take two more double time steps.

b. Bring your feet together and begin double timing in place without loss of cadence.

3. The Command "Double Time, MARCH" Resumes the March at Double Time
  - a. At "MARCH," take two more steps in place.
  - b. Step off with 180, 36-inch steps per minute.
4. When Marking Time
  - a. On the command "MARCH," take one more step in mark time.
  - b. Commence marching at double time in place.

2206. HALF STEP. The purpose of half step is to march forward at quick time taking 15-inch steps. It may be executed when halted at attention or marching forward at quick time. While marching it may be given as either foot strikes the deck. The command is "Half Step, MARCH."

1. At the Halt

- a. On the command "Half Step," shift your weight to your right leg without noticeable movement.
- b. On the command "MARCH," step off forward in quick time cadence with 15-inch steps. The balls of your feet should strike the deck before your heels. At the same time begin swinging your arms 6 inches to the front and 3 inches to the rear.

2. Marching in Quick Time

- a. On the command "MARCH," take one more 30-inch step.
  - b. Begin the 15-inch steps as explained above. (See paragraph 2206.1.)
3. To resume quick time from half step, the command is "Forward, MARCH." It may be given as either foot strikes the deck.
    - a. On "MARCH," take one more half step.
    - b. Step off at quick time.

2207. SIDE STEP. The purpose of side step is to move the unit a short distance to the right or left. There are no counts, however there is a cadence of 1-2.

1. The command "Right (Left) Step, MARCH" is given only when you are at a halt.
2. At the command "MARCH," move your right foot 12 inches to the right, then place your left foot smartly beside your right. Repeat this movement at quick time. Keep your legs straight, but not stiff. Hold your arms at your sides as in the position of attention.

2208. BACK STEP. The purpose of back step is to march the unit backwards for a short distance.

1. The command "Backward, MARCH" is given only when you are at a halt.

2. At the command **"MARCH,"** step off to the rear with your left foot and take 15-inch steps at quick time. At the same time swing your arms 6 inches to the front and 3 inches to the rear.

2209. TO FACE TO THE RIGHT (LEFT) IN MARCHING

1. This is an important part of the following movements: column right (left), by the right (left) flank, close, take interval, and extend. For instructional purposes, the command is **"By The Right (Left) Flank, MARCH."**

2. From a Halt, on the Command "MARCH"

a. For right flank, turn 90 degrees to the right by pivoting on the ball of the right foot and (using a cross over step) stepping off with the left foot 30 inches in the new direction of march.

b. For left flank, turn 90 degrees to the left by pivoting on the ball of the right foot and stepping off 30 inches with the left foot in the new direction of march.

3. While marching, the command of execution is given as the foot of the desired direction of movement strikes the deck.

a. On **"MARCH,"** without losing cadence, take one more step in the original direction.

b. Pivot to the right (left) and step off in the new direction. If commanded and executed properly, the pivot will be on the foot away from the desired direction of movement, and the first step in the new direction will be with the other foot. The pivot and step are done together in one count. When marching to the flank the only other movement that can be given is a flanking movement in the opposite direction that will bring the individual or unit back to the original front.

2210. TO FACE TO THE REAR WHILE MARCHING. The purpose of this movement is to march the unit to the rear for a short distance.

1. The command is **"To the Rear, MARCH."** It may be executed when halted or while marching at either quick time or double time. When marching the command of execution **"MARCH"** is given when the right foot strikes the deck. When marching to the rear, the only movement that can be given is **"To the Rear, MARCH"** in order to bring the individual or unit back to its' original front.

2. To March to the Rear From a Halt

a. The command is **"To the Rear, MARCH."**

b. On **"MARCH,"** step forward with the left foot.

c. Turn about to the right on the balls of both feet and immediately step out to the rear with the left foot. This is done without loss of cadence. When turning, the feet should be about 15 inches apart.

3. When at Quick Time

a. On the command "**MARCH**," take one more step.

b. Turn about to the right on the balls of both feet and immediately step off to the rear with your left foot. This is done without loss of cadence. When turning, the feet should be about 15 inches apart.

4. When at Double Time

a. On "**MARCH**," follow the sequence of steps and actions below.

**As this foot strikes the deck****Take the following action**

RIGHT	" <b>MARCH</b> " is given.
LEFT	36-inch step.
RIGHT	36-inch step. Then in place double time.
LEFT	Pivot 90 degrees to the right
RIGHT	Heels together.
LEFT	Pivot 90 degrees to the right.
RIGHT	Heels together.
LEFT	36-inch step in the new direction.

2211. TO MARCH TO THE FLANK. The purpose of this movement is to march the entire unit to the right (left) for a short distance. It may be executed when halted or while marching at either quick time or double time. The command is "**By the Right (Left) Flank, MARCH.**" When marching the command of execution is given as the foot in the direction of the movement strikes the deck.

1. From a Halt

a. For right flank, turn 90 degrees to the right by pivoting on the ball of the right foot and (using a cross over step) stepping off with the left foot 30 inches in the new direction of march.

b. For left flank, turn 90 degrees to the left by pivoting on the ball of the right foot and stepping off 30 inches with the left foot in the new direction of march.

2. While at Quick Time

a. On "**MARCH**," take one more step.

b. Turn to the right (left) on the ball of the left (right) foot. At the same time, step off 30 inches in the new direction with the right (left) foot.

3. While Double Timing

a. On "**MARCH**," use the following sequence and actions.

<b>By the Left Flank</b>		<b>By the Right Flank</b>	
<b>Step</b>	<b>Action</b>	<b>Step</b>	<b>Action</b>
LEFT	" <b>MARCH</b> " is given.	RIGHT	" <b>MARCH</b> " is given.
RIGHT	36-inch step.	LEFT	36-inch step in
LEFT	in place double timing.		place double timing.
RIGHT	Pivot 90 degrees to the left.	LEFT	Pivot 90 degrees to the
LEFT	36-inch step in new direction.		right.
		RIGHT	36-inch step in new direction.

2212. TO CHANGE STEP. The purpose of this movement is to change the cadence count without changing the rhythm of the cadence.

1. The command is "**Change Step, MARCH.**" It may be given while marching at quick or double time, marking time, or double timing in place. The command of execution is given as the right foot strikes the deck.

2. While Marching at Quick Time or Double Time

a. On "**MARCH,**" take one more step, 30 or 36 inches, as appropriate.

b. As your right foot comes forward to the next step, place the toe near the left heel and step out again with the left foot. This changes the cadence count, but not the rhythm.

3. While Marking Time

a. On "**MARCH,**" lift and lower the left foot twice in succession.

b. The second time it touches the deck, raise the right foot and continue marking time.

4. While Double Timing in Place

a. On "**MARCH,**" hop twice on the left foot.

b. Continue double timing in place.

2213. TO MARCH AT EASE. The purpose of this movement is to give troops a rest from marching at attention or when keeping in step becomes difficult due to rough terrain.

1. The command is "**At Ease, MARCH.**" It is given as either foot strikes the deck and only while marching at quick time.

2. After "**MARCH,**" you are no longer required to march in cadence, but must keep interval and distance. Do not talk.

2214. TO MARCH AT ROUTE STEP

1. The command is "**Route Step, MARCH.**" It is commanded as either foot strikes the deck and only while marching at quick time.

2. After "**MARCH,**" you are no longer required to march in cadence, but must keep interval and distance. You may talk, but in a low voice.

2215. TO RESUME MARCHING AT QUICK TIME FROM ROUTE STEP OR AT EASE

1. The command is "**Squad (Platoon, Company, Detail, etc.), ATTENTION.**"

2. After commanding "**ATTENTION,**" the unit leader will count cadence until all troops are in step. Pick up the step as soon as possible and continue marching at attention.
3. Commands that involve precision in execution will not be given until the command to resume marching at quick time has been given and all members of the formation have picked up the step and cadence.



MARINE CORPS DRILL AND CEREMONIES MANUAL

PART I: DRILL

CHAPTER 3

MANUAL OF ARMS WITH THE M16 RIFLE

	<u>PARAGRAPH</u>	<u>PAGE</u>
GENERAL . . . . .	3000	3-5

SECTION 1: MANUAL OF ARMS WITH A PARADE SLING

GENERAL . . . . .	3100	3-7
ORDER ARMS . . . . .	3101	3-9
REST POSITIONS . . . . .	3102	3-10
TRAIL ARMS . . . . .	3103	3-11
PORT ARMS FROM ORDER ARMS . . . . .	3104	3-12
MOVEMENTS FROM PORT ARMS . . . . .	3105	3-13
RIGHT SHOULDER ARMS FROM ORDER ARMS . . . . .	3106	3-16
MOVEMENTS FROM RIGHT SHOULDER ARMS . . . . .	3107	3-18
LEFT SHOULDER ARMS FROM ORDER ARMS . . . . .	3108	3-21
MOVEMENTS FROM LEFT SHOULDER ARMS . . . . .	3109	3-22
PRESENT ARMS FROM ORDER ARMS . . . . .	3110	3-23
MOVEMENTS FROM PRESENT ARMS . . . . .	3111	3-24
RIFLE SALUTE . . . . .	3112	3-26
INSPECTION ARMS (WITH AND WITHOUT MAGAZINE) . . . . .	3113	3-28
PORT ARMS FROM INSPECTION ARMS (WITH AND WITHOUT MAGAZINE) . . . . .	3114	3-30
FIX AND UNFIX BAYONETS . . . . .	3115	3-31
AUTHORIZED MANUAL OF ARMS WITH THE M16 RIFLE . . . . .	3116	3-31

SECTION 2: MANUAL OF ARMS WITH A LOOSENEED SLING

GENERAL . . . . .	3200	3-33
SLING ARMS . . . . .	3201	3-33

MARINE CORPS DRILL AND CEREMONIES MANUAL

	<u>PARAGRAPH</u>	<u>PAGE</u>
UNSLING ARMS . . . . .	3202	3-35
ADJUST SLING . . . . .	3203	3-35
SALUTING AT SLING ARMS . . . . .	3204	3-36
PORT ARMS FROM SLING ARMS . . . . .	3205	3-37
INSPECTION ARMS FROM SLING ARMS . . . . .	3206	3-38

SECTION 3: MANUAL OF ARMS MOVEMENTS WITH THE M203

GENERAL . . . . .	3300	3-41
PRESENT ARMS WITH THE M203 . . . . .	3301	3-42
INSPECTION ARMS WITH THE M203 . . . . .	3302	3-42

FIGURE

3-1	DRILL NOMENCLATURE OF THE U.S. RIFLE, 5.56MM, M16. . . . .	3-8
3-2	ORDER ARMS . . . . .	3-9
3-3	PARADE REST. . . . .	3-10
3-4	TRAIL ARMS . . . . .	3-11
3-5	MOVEMENTS FROM ORDER ARMS TO PORT ARMS . . . . .	3-12
3-6	MOVEMENTS FROM PORT ARMS TO ORDER ARMS . . . . .	3-13
3-7	MOVEMENTS FROM PORT ARMS TO LEFT SHOULDER ARMS . . . . .	3-14
3-8	MOVEMENTS FROM PORT ARMS TO RIGHT SHOULDER ARMS. . . . .	3-15
3-9	MOVEMENTS FROM PORT ARMS TO PRESENT ARMS. . . . .	3-16
3-10	MOVEMENTS FROM ORDER ARMS TO RIGHT SHOULDER ARMS . . . . .	3-17
3-11	MOVEMENTS FROM RIGHT SHOULDER ARMS TO PORT ARMS. . . . .	3-19
3-12	RIGHT SHOULDER ARMS TO ORDER ARMS. . . . .	3-20
3-13	MOVEMENTS FROM ORDER ARMS TO LEFT SHOULDER ARMS. . . . .	3-21
3-14	MOVEMENTS FROM LEFT SHOULDER ARMS TO PORT ARMS . . . . .	3-23
3-15	MOVEMENTS FROM ORDER ARMS TO PRESENT ARMS. . . . .	3-24

MARINE CORPS DRILL AND CEREMONIES MANUAL

	<u>PAGE</u>
3-16	MOVEMENTS FROM PRESENT ARMS TO ORDER ARMS. . . . . 3-25
3-17	RIFLE SALUTES. . . . . 3-27
3-18	INSPECTION ARMS FROM ORDER ARMS . . . . . 3-29
3-19	CRADLE RIFLE INSIDE RIGHT ELBOW. . . . . 3-34
3-20	POSITION OF SLING ARMS. . . . . 3-34
3-21	SALUTE AT SLING ARMS . . . . . 3-36
3-22	PORT ARMS FROM SLING ARMS. . . . . 3-37
3-23	INSPECTION ARMS FROM SLING ARMS. . . . . 3-39
3-24	SLING ARMS WITH THE M203 . . . . . 3-41
3-25	INSPECTION ARMS WITH THE M203 . . . . . 3-42



MARINE CORPS DRILL AND CEREMONIES MANUAL

PART I: DRILL

CHAPTER 3

MANUAL OF ARMS WITH THE M16 RIFLE

3000. GENERAL. This Chapter covers the manual of arms movements for the M16 rifle with both the parade and loosened sling, and the M16 with the M203 grenade launcher attached. Whenever executing any manual of arms movements ensure that the weapon has been cleared and that all weapons handling procedures are followed.



MARINE CORPS DRILL AND CEREMONIES MANUAL

CHAPTER 3

MANUAL OF ARMS WITH THE M16 RIFLE

SECTION 1: MANUAL OF ARMS WITH A PARADE SLING

3100. GENERAL

1. Prior to commencing the manual of arms, the magazine is removed, and the sling is drawn tight and positioned on the left (selector switch) side of the rifle. This configuration is called a parade sling and facilitates execution of the manual of arms. Figure 3-1 identifies the drill nomenclature for the M16 rifle with sling.
2. All movements of the manual of arms are executed smartly and with snap.
3. On the command "FALL IN," if armed with a rifle it will be positioned at order arms.
4. Facings, alignments, and short distance marching movements are executed from order arms. Side step, back step, open and close ranks, and close and extend are short distance movements. Forward march may be given from order arms to march units forward for a short distance. When these movements are commanded while at order arms, it is necessary to come automatically to trail arms and step off simultaneously on the command of execution for the movement. The rifle is returned to order arms upon halting.
5. Before a command for any marching movement (other than the executions stated in paragraph 3100.3) is given to armed troops, they are faced in the direction of march and their weapons brought to right (left) shoulder, port, or sling arms by the appropriate command. After a marching movement has been completed and it is desired to execute a facing movement, the command to order or unsling arms is given, followed by the command for the facing movement.
6. When at a position other than sling arms, the troops must come to port arms for double time. When the troops are in formation, the commander gives the appropriate commands.
7. Generally, the M16 rifle should be carried at sling arms except for ceremonies and drill periods.

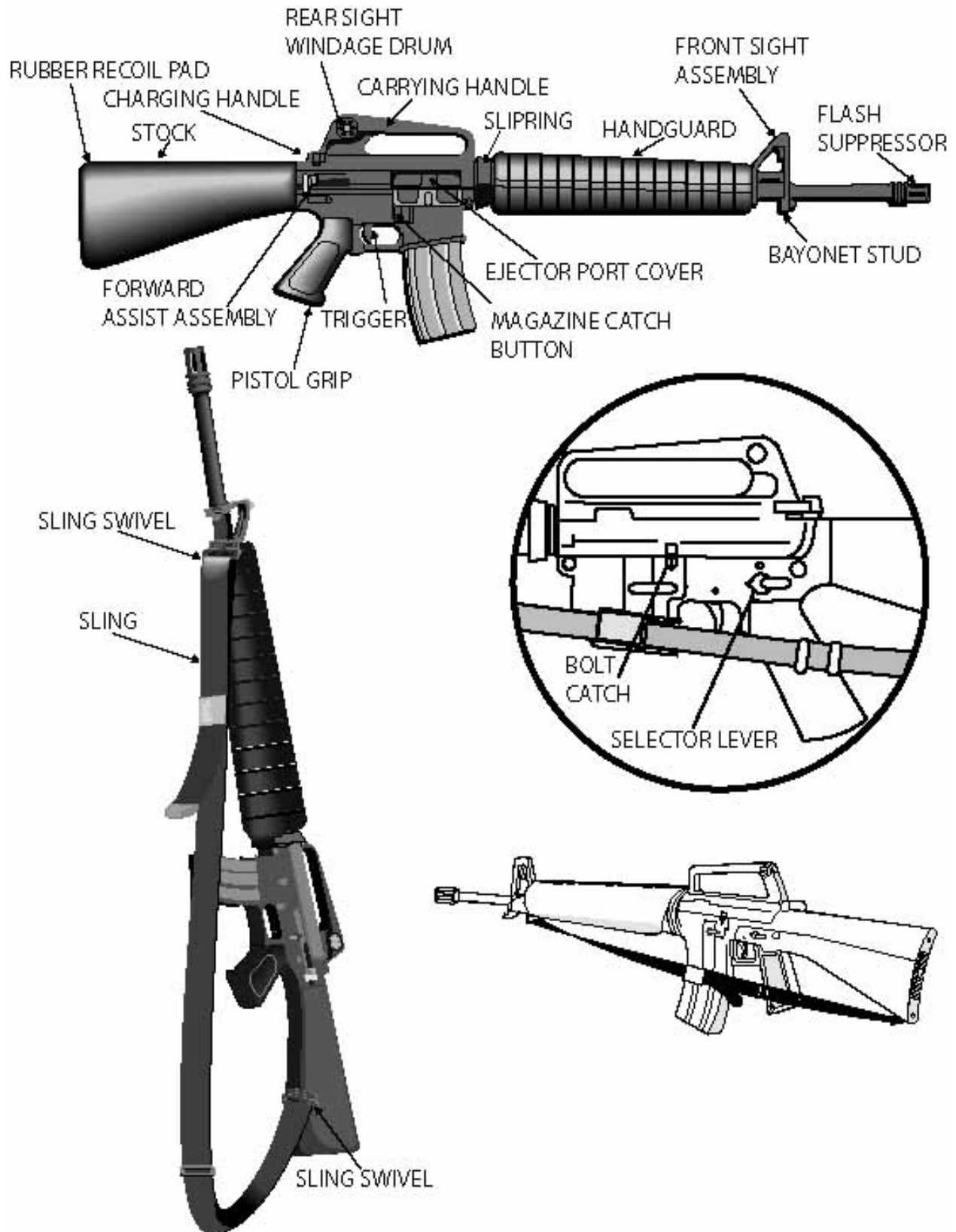

Figure 3-1.--Drill Nomenclature of the U.S. Rifle, 5.56mm, M16.



3101. ORDER ARMS

1. The basic position of the rifle manual is order arms. (See figure 3-2). It is the position assumed by an individual halted at attention with the rifle. It is assumed on the command "**ATTENTION**" from any of the rest positions except fall out. Order arms is also assumed on the command "**FALL IN**" and on the command "**Order, ARMS,**" from any position in the manual except inspection arms and sling arms.

2. Properly executed, the butt of the rifle rests on the deck, and the stock rests along the outer edge of the right shoe. The pistol grip is to the front and the barrel is in a near vertical position. The rifle is grasped by the right hand at the junction of the front sight assembly and the barrel. The barrel rests in the "V" formed by the thumb and forefinger. The fingers are extended and joined and placed on line with the barrel. The thumb is placed along the trouser seam and the entire right arm is behind the rifle. This may cause a slight bend to the right arm of shorter individuals. Persons, too tall to reach the junction of the barrel and front sight assembly, may slide their hand up the barrel so that their posture remains erect.



a. Front.



b. Right Side.

Figure 3-2.--Order Arms.

3102. REST POSITIONS

1. The purpose of rest positions with the rifle is the same as rest positions without arms. They are commanded and executed as without arms with the following exceptions and additions.
2. On the command "**Parade, REST,**" the left foot is moved 12 inches to the left. The rifle butt is kept against the right foot. The grasp of the right hand is moved up the barrel to just below the flash suppresser with the fingers joined and curled with the forefinger touching the thumb. The right arm is straightened directly to the front so that the muzzle points forward and up. (See figure 3-3a.) At the same time the left foot is moved, the left hand is placed behind the back just below the belt line with fingers and thumb extended and joined and the palm facing the rear. (See figure 3-3b.)



a. Side View.



b. Rear View.

Figure 3-3.--Parade Rest.

3. On the command "**AT EASE**" or "**REST,**" the right foot remains in place and the rifle is held as in parade rest with the right arm relaxed slightly.

3103. TRAIL ARMS

1. The purpose of trail arms is to raise the rifle off the deck when facing, aligning or moving a short distance. It is executed in one count simultaneously with the first count of the movement commanded, and upon that movement's command of execution. It may be executed only when halted at order arms. The rifle is returned to order arms quietly and without command upon completion of the movements.

2. For training purposes, trail arms may be executed on command. The command is **"Trail, ARMS."** At the command of execution **"ARMS,"** the rifle is raised vertically 3 inches off the deck. The wrist is kept straight with the thumb along the seam of the trousers. (See figure 3-4.)

3. At the command **"Order, ARMS,"** the rifle is quietly lowered to the position of order arms.



a. Front



b. Right Side

Figure 3-4.--Trail Arms.

3104. PORT ARMS FROM ORDER ARMS

1. The purpose of this movement is to bring the rifle to a two-handed carry position. This is a two-count movement from order arms. It is executed when halted at order arms. The command is **"Port, ARMS."**

2. At the command of execution, and for the count of one, slide the right hand up and grasp the barrel near the flash suppresser. The fingers are joined and wrapped around the barrel with the thumb wrapped around the inboard portion. Without loss of motion, raise and carry the rifle diagonally across the front of the body until the right hand is level with and slightly to the left of the face. The right wrist is on the outboard portion of the front sight assembly. The elbow is held down without strain and nearly touches the handguard. The barrel is up and bisecting the angle formed by the neck and left shoulder. The pistol grip is to the left. The butt is in front of the right hip. At the same time, smartly grasp the handguard with your left hand, just above the sling. The sling is included in the grasp. The fingers are joined and grasping the rifle. The little finger is in line with the sling with the thumb on the inboard side of the handguard. The left wrist and forearm are straight. The elbow is held in against the body. (See figure 3-5b.)

3. On the second count, release the grasp of the right hand and smartly re-grasp the small of the stock. The fingers are joined and wrapped around the small of the stock with the thumb wrapped around the inboard portion. The right wrist and forearm are straight and parallel to the deck. The elbow is held into the side and the upper arm is in line with the back. The rifle is about 4 inches from the body. (See figure 3-5c.)



a. Start.



b. Count One.



c. Count Two.

Figure 3-5.--Movements from Order Arms to Port Arms.

3105. MOVEMENTS FROM PORT ARMS

1. The purpose of these movements is to move the rifle from port arms to order arms, left shoulder arms, right shoulder arms and present arms.
2. Order arms is a three-count movement. It is executed only when halted at port arms. The command is "**Order, ARMS.**"
  - a. At the command of execution, and for the count of one, the right hand is moved from the small of the stock and smartly re-grasps the barrel. The palm of the right hand is to the rear. The fingers are joined and wrapped around the barrel with the thumb wrapped around the inboard portion. The little finger is just above the bayonet stud. The right wrist is on the outboard portion of the front sight assembly. The elbow is held down without strain and nearly touches the handguard. (See figure 3-6b.)
  - b. On the second count, lower the rifle initially with the left hand while changing the grasp of the right hand to the junction of the barrel and the front sight assembly as in the position of order arms. Without loss of motion, release the grasp of the left hand from the handguard and, with your right hand, carry the weapon to your right side until the butt is 3 inches from the deck. The barrel is in a vertical position and the pistol grip is to the front. At the same time guide the weapon with the left hand until the right thumb is on the trouser seam. The fingers of the left hand are extended and joined and touch the rifle near the flash suppresser. The palm of the left hand is toward the rear. The left wrist and forearm are straight and the left elbow is in against the body. (See figure 3-6c.)
  - c. On the third count, return the left hand to the left side at the position of attention. At the same time, gently lower the rifle to the deck with the right hand. (See figure 3-6d.)



a. Start.



b. Count One.



c. Count Two.



d. Count Three.

Figure 3-6.--Movements from Port Arms to Order Arms.

3. Left shoulder arms from port arms is a two-count movement. It may be executed while halted at attention or while marching. The command is **"Left Shoulder, ARMS."**

a. At the command of execution, and for the count of one, release the grasp of the left hand from the handguard and, with the right hand, carry the rifle to the left side rotating it a quarter turn counterclockwise. Place it on the left shoulder. The elbow is held down without strain. At the same time, grasp the butt of the rifle with the left hand in the same manner as for right shoulder arms. (See figure 3-7b.)

b. On the second count, move your right hand back to the right side at the position of attention. The rifle is held at a 60-degree angle from the deck. (See figure 3-7c.)

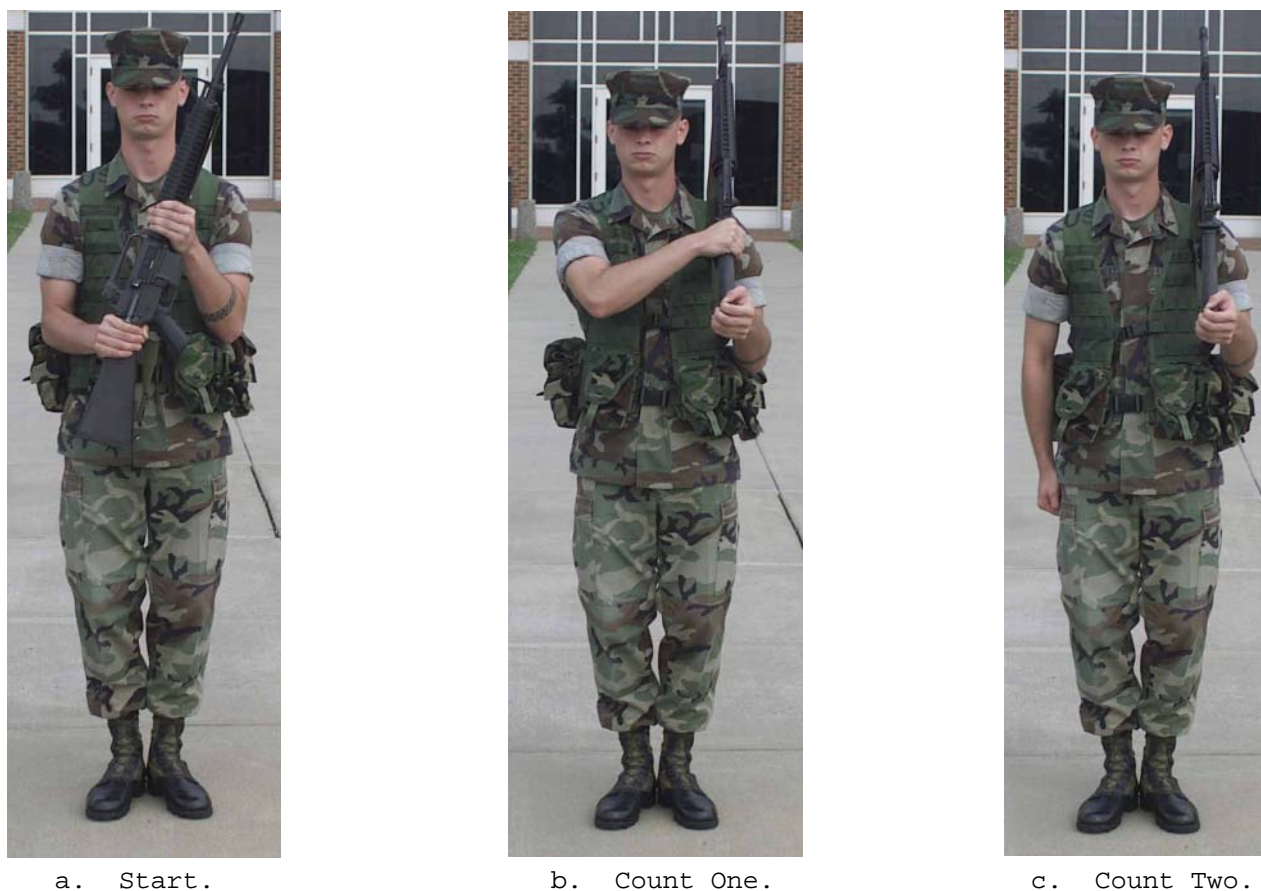

Figure 3-7.--Movements from Port Arms to Left Shoulder Arms.

4. Right shoulder arms from port arms is a three-count movement. It may be executed while halted at attention or while marching. The command is **"Right Shoulder, ARMS."**

a. On the command of execution, and for the count of one, move the right hand from the small of the stock and grasp the butt placing the heel of the butt between the first two fingers. The heel will be visible between the index and middle fingers. (See figure 3-8b.)

b. On the second count, release the grasp of the left hand from the handguard and carry the rifle to the right side. The left hand remains in contact with the rifle in order to assist in the movement. At the same time, with the right hand, rotate the rifle a quarter turn counterclockwise and place the rifle into the right shoulder. Slide the left hand to the junction of the stock and receiver just below the charging handle. Guide the rifle into the shoulder with the left hand. The thumb and fingers are extended and joined with the palm turned toward the body. The first joint of the left forefinger touches the rear of the receiver. The left wrist and forearm are straight. The left elbow is held against the body. The grasp of the right hand is unchanged. The right wrist and forearm are straight and parallel to the deck. The elbow is held into the side with the upper arm in line with the back. (See figure 3-8c.)

c. On the third count, move your left hand back to the left side at the position of attention. The rifle is held at a 60-degree angle from the deck. (See figure 3-8d.)

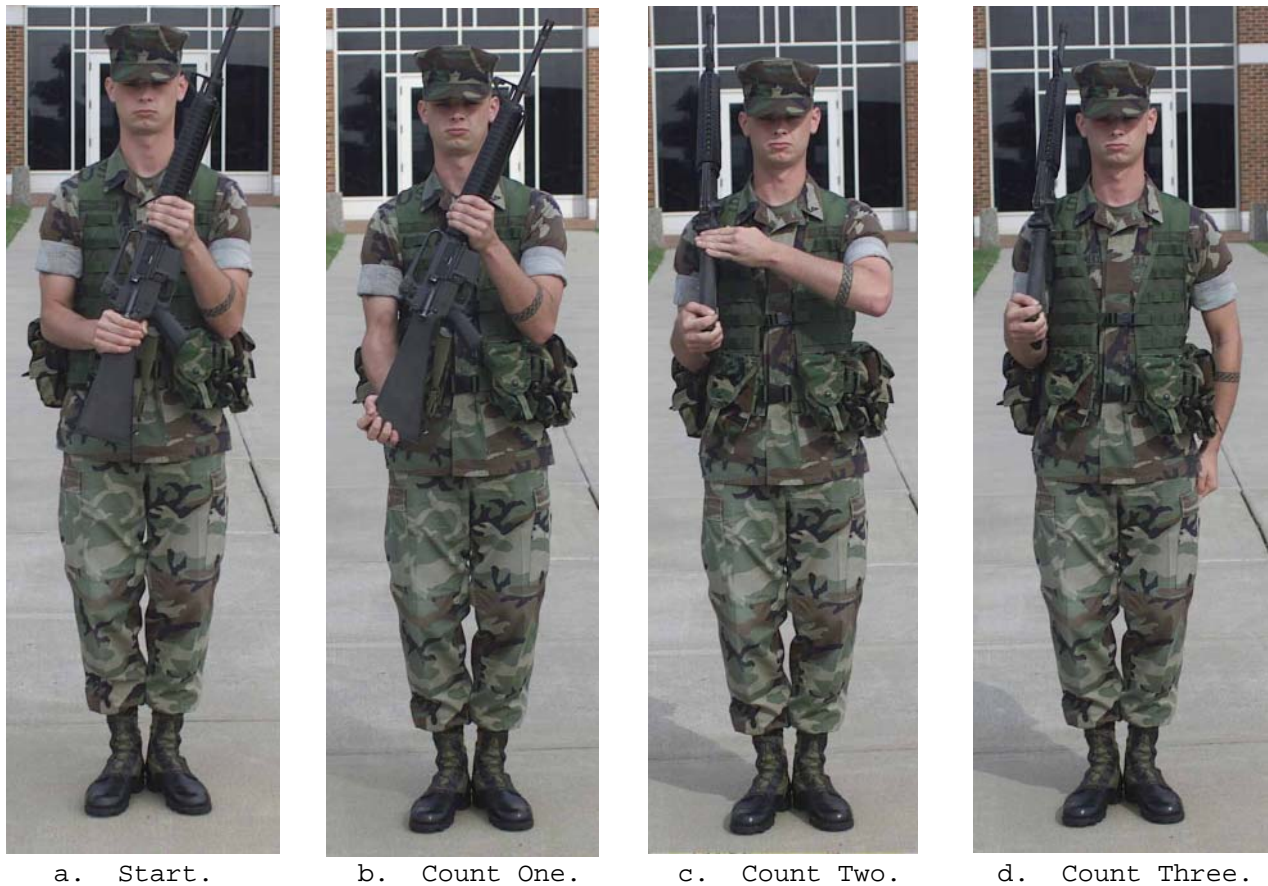

Figure 3-8.--Movements from Port Arms to Right Shoulder Arms.

5. Present arms from port arms is a one-count movement. It is only executed while halted at attention. The movement may be executed without command, for a sentry on post, or at the command of "**Present, ARMS.**" To execute the movement the rifle is rotated clockwise with the right hand, the muzzle moves to the right, and the rifle is re-grasped above the sling with the left hand. The sling is included in the grasp. (See figure 3-9.)



a. Start.



b. Present Arms.

Figure 3-9.--Movements from Port Arms to Present Arms.

3106. RIGHT SHOULDER ARMS FROM ORDER ARMS

1. The purpose of this movement is to bring the rifle to a position on the right shoulder. This is a four-count movement from order arms. It is executed when halted at order arms. The command is **"Right Shoulder, ARMS."**
2. On the command of execution, and for the count of one, grasp the barrel of the weapon with the right hand. Without loss of motion, raise and carry the rifle diagonally across the front of the body until the right hand is level with and slightly to the left of the face. The right wrist and forearm are straight. The right elbow is held down without strain. The barrel is up and bisecting the angle formed by the neck and left shoulder. At the same time, grasp the handguard with the left hand (as in count one for port arms). (See figure 3-10b.)



3. On the second count, release the barrel with the right hand and grasp the butt placing the heel of the butt between the first two fingers. The heel will be visible between the index and middle fingers. (See figure 3-10c.)

4. On the third count, release the grasp of the left hand from the handguard and carry the rifle to the right side. The left hand remains in contact with the rifle in order to assist in the movement. At the same time, with the right hand, rotate the rifle a quarter turn counterclockwise and place the rifle into the right shoulder. Slide the left hand to the junction of the stock and receiver just below the charging handle. Guide the rifle into the shoulder with the left hand. The thumb and fingers are extended and joined with the palm turned toward the body. The first joint of the left forefinger touches the rear of the receiver. The left wrist and forearm are straight. The left elbow is held against the body. The grasp of the right hand is unchanged. The right wrist and forearm are straight and parallel to the deck. The elbow is held into the side with the upper arm in line with the back. (See figure 3-10d.)

5. On the fourth count, move your left hand back to the left side at the position of attention. The rifle is held at a 60-degree angle from the deck. (See figure 3-10e.)



a. Start.



b. Count One.

Figure 3-10.--Movements from Order Arms to Right Shoulder Arms.



c. Count Two.



d. Count Three.



e. Count Four.

Figure 3-10.--Movements from Order Arms to Right Shoulder Arms--Continued.

3107. MOVEMENTS FROM RIGHT SHOULDER ARMS

1. The purpose of these movements is to move the rifle from right shoulder arms to port arms, order arms, left shoulder arms or present arms.

2. Port arms from right shoulder arms is a two-count movement. It may be executed while halted at attention or when marching. The command is **"Port, ARMS."**

a. At the command of execution, and for the count of one, pull the rifle butt back quickly with the right hand so the rifle comes off the right shoulder. At the same time, with the right hand rotate the rifle a quarter turn clockwise so that the pistol grip is to the left. Allow the rifle to fall diagonally across the front of the body. Bring the left hand up and smartly grasp the handguard with the sling included in the grasp. The fingers are joined grasping the handguard. The little finger is in line with the sling but not touching it. The thumb is on the inboard side. The left wrist and forearm are straight. The elbow is held in against the body. The barrel is up; bisecting the angle formed by your neck and left shoulder. The butt is in front of the right hip. The grasp of the right hand has not changed. The right arm is nearly extended with the elbow held against the body. (See figure 3-11b.)

b. On the second count, release the grasp of the right hand from the butt and smartly re-grasp the small of the stock. The fingers are joined and wrapped around the small of the stock with the thumb wrapped around the inboard portion. The right wrist and forearm are straight and parallel to the deck. The elbow is held into the side and the upper arm is in line with the back. The rifle is about 4 inches from the body and now in the position of port arms. (See figure 3-11c.)

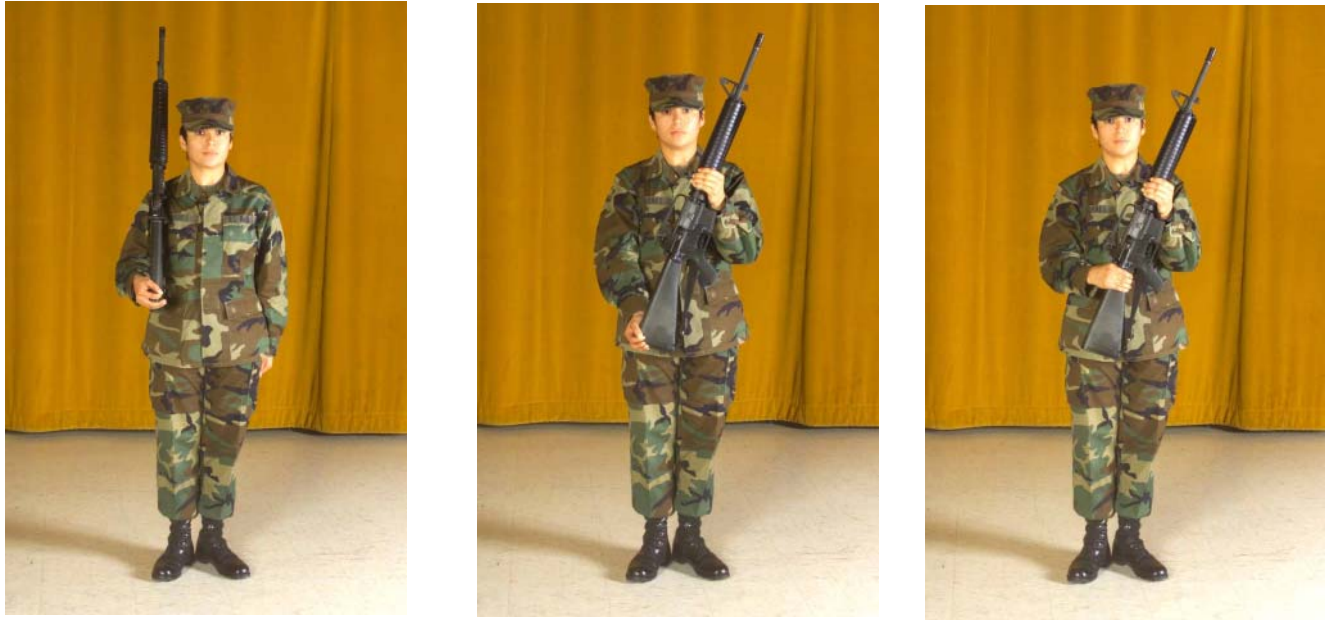

a. Start.

b. Count One.

c. Count Two.

Figure 3-11.--Movements from Right Shoulder Arms to Port Arms.

3. Order arms from right shoulder arms is a four-count movement. Order arms may be executed only when halted at attention. The command is "**Order, ARMS.**"

a. At the command of execution, and for the count of one, pull the rifle butt back quickly with the right hand so the rifle comes off the right shoulder. At the same time, with the right hand rotate the rifle a quarter turn clockwise so that the pistol grip is to the left. Allow the rifle to fall diagonally across the front of the body. Bring the left hand up and smartly grasp the handguard with the sling included in the grasp. The fingers are joined grasping the handguard. The little finger is in line with the slpring but not touching it. The thumb is on the inboard side. The left wrist and forearm are straight. The elbow is held in against the body. The barrel is up bisecting the angle formed by your neck and left shoulder. The butt is in front of the right hip. The grasp of the right hand has not changed. The right arm is nearly extended with the elbow held against the body. (See figure 3-12b.)

b. On the second count, release the grasp of the right hand from the butt and smartly re-grasp the barrel. The palm of the right hand is to the rear. The fingers are joined and wrapped around the barrel with the thumb wrapped around the inboard portion. The little finger is just above the bayonet stud and the right wrist in on the outboard portion of the front sight assembly. (See figure 3-12c.)

c. On the third count, lower the rifle initially with the left hand while changing the grasp of the right hand to the junction of the barrel and the front sight assembly as in the position of order arms. Without loss of motion, release the grasp of the left hand from the handguard and with your right hand, carry the weapon to your right side until the butt is 3 inches from the deck. At the same time, guide the weapon with the left hand until the right thumb is on the trouser seam. The fingers of the left hand are extended and joined and touching the

rifle, near the flash suppresser. The palm of the left hand is toward the rear. The wrist and forearm are straight and the left elbow is in against the body. (See figure 3-12d.)

d. On the fourth count, return the left hand to the left side at the position of attention. At the same time, gently lower the rifle to the deck with the right hand. (See figure 3-12e.)



a. Start.



b. Count One.



c. Count Two.



d. Count Three.



e. Count Four.

Figure 3-12.--Right Shoulder Arms to Order Arms.

4. Left shoulder arms from right shoulder arms is a four-count movement. It may be executed while halted at attention or while marching. The command is "**Left Shoulder, ARMS.**" The first two counts move the rifle to port arms as described in paragraph 3107.2. The second two counts carry the rifle into the left shoulder as described in paragraph 3105.3.

5. Present arms from right shoulder arms is a three-count movement. The first two counts move the weapon to port arms as described in paragraph 3107.2. For the third count rotate the weapon to present arms as described in paragraph 3105.5.

#### 3108. LEFT SHOULDER ARMS FROM ORDER ARMS

1. The purpose of this movement is to bring the rifle to a position on the left shoulder. This is a four-count movement from order arms. It is executed when halted at order arms. The command is "**Left Shoulder, ARMS.**"

2. At the command "**ARMS,**" the rifle is brought to port arms on the first two counts. (See figures 3-13b and c.)

3. On the third count, release the grasp of the left hand from the handguard and, with the right hand, carry the rifle to the left side rotating it a quarter turn counterclockwise. Place it on the left shoulder. The elbow is held down without strain. At the same time, grasp the butt of the rifle with the left hand in the same manner as for right shoulder arms. (See figure 3-13d.)

4. On the fourth count, move your right hand back to the right side at the position of attention. The rifle is held at a 60-degree angle from the deck. (See figure 3-13e.)



a. Start.



b. Count One.

Figure 3-13.--Movements from Order Arms to Left Shoulder Arms.



c. Count Two.

d. Count Three.

e. Count Four.

Figure 3-13.--Movements from Order Arms to Left Shoulder Arms--Continued.

#### 3109. MOVEMENTS FROM LEFT SHOULDER ARMS

1. The purpose of these movements is to move the rifle from left shoulder arms to port arms, order arms, right shoulder arms or present arms.

2. Port arms is a two-count movement. It is executed when halted or marching at left shoulder arms. The command is "**Port, ARMS.**"

a. On the command of execution, and for the count of one, the right hand is moved up across the body and grasps the rifle at the stock below the charging handle. (See figure 3-14b.)

b. On the second count, the grasp of the left hand is released, and the rifle is brought from the shoulder diagonally across the body with the right hand and re-grasped at the handguard just above the sling with the left hand as in the position of port arms. (See figure 3-14c.)

3. Order arms from left shoulder arms is a five-count movement. Order arms may be executed only when halted at attention. The command is "**Order, ARMS.**" For the first two counts, move the rifle to port arms as described in figures 13d and e. For the last three counts, the rifle is brought to order arms as described in figures 3-12c, d, and e.

4. Right shoulder arms from left shoulder arms is a five-count movement. The movement may be executed while halted at attention or while marching; the command is "**Right Shoulder, ARMS.**" For the first two counts of the movement the rifle is moved to port arms. (See figure 3-14.) The next three counts move the rifle to right shoulder arms as described in paragraph 3105.4.



a. Start.

b. Count One.

c. Count Two.

Figure 3-14.--Movements from Left Shoulder Arms to Port Arms.

5. Present arms from left shoulder arms is a three-count movement. The movement may be executed only while halted at attention. The movement may be executed without command by a sentry on post or on the command **"Present, ARMS."** The first two counts bring the rifle to port arms described in paragraph 3109.2. For the third count rotate the weapon to present arms as described in paragraph 3105.5.

#### 3110. PRESENT ARMS FROM ORDER ARMS

1. The purpose of this movement is to render a salute to persons or colors when in formation or when posted as a sentry. Order arms to present arms is a two-count movement and is executed when halted at order or port arms. The command is **"Present, ARMS."**

a. At the command of execution, and for the count of one, slide the right hand up and grasp the barrel near the flash suppresser. The fingers are joined and wrapped around the barrel. Without loss of motion, raise and carry the rifle to a vertical position centered on the body. The pistol grip is to the front. The wrist is on the right side of the front sight assembly. The elbow is held down without strain. At the same time, smartly grasp the rifle at the handguard with the left hand just above the slirpring. The sling is included in the grasp. The fingers are joined and wrapped around the handguard. The little finger is on line with the slirpring with the thumb on the inboard side of the handguard. The left wrist and forearm are straight and parallel to the deck. The elbow is held into the side with the upper arm on line with the back. (See figure 3-15b.)

b. On the second count, release the grasp of the right hand and re-grasp the small of the stock. The charging handle rests on the thumb of the right hand. The fingers are extended and joined diagonally across the small of the stock. The right wrist and forearm remain straight. The elbow is slightly bent and held against the body. The left thumb is 4 inches from the body. (see figure 3-15c.)



a. Start.

b. Count One.

c. Count Two.

Figure 3-15.--Movements from Order Arms to Present Arms.

#### 3111. MOVEMENTS FROM PRESENT ARMS

1. The purpose of these movements is to terminate present arms and to move the rifle from present arms to order arms, port arms, and left or right shoulder arms. These movements are only executed when halted at present arms.

2. Order arms from present arms is a three-count movement. The command is **"Order, ARMS."**

a. At the command of execution, and for the count of one, release the grasp of the right hand from the small of the stock and re-grasp the barrel. The palm of the right hand is to the left. The fingers are joined and wrapped around the barrel. The little finger is just above the bayonet stud. The wrist is on the right side of the front sight assembly. The elbow is held down without strain. (See figure 3-16b.)

b. On the second count, lower the rifle initially with the left hand while changing the grasp of the right hand to the junction of the barrel and the front sight assembly as in the position of order arms. Without loss of motion, release the grasp of the left hand from the handguard and, with the right hand, carry the weapon to the right side until the butt is 3 inches from the deck. The barrel is in a vertical position and the pistol grip is to the front. At the same time, guide the weapon into the right side with the left hand. The fingers of the left hand are extended and joined with the thumb along the hand. The tips of the forefinger and middle finger are touching metal at a point near the flash suppresser. The palm is towards the rear. The left wrist and forearm are straight. Guide the weapon into the right side so that the thumb of the right hand will be on the trouser seam and push back on the barrel until the toe of the stock is on line with the toe of the right shoe. The entire right arm is behind the rifle. (See figure 3-16c.)



c. On the third count, quietly lower the rifle to the deck with the right hand so that the toe of the rifle is on line with the toe of the right shoe, and the barrel is in a near vertical position; at the same time smartly and in the most direct manner return the left hand to the side as in the position of attention. The thumb of the right hand remains along the trouser seam and the right arm remains behind the rifle. (See figure 3-16d.)



a. Start.



b. Count One.



c. Count Two.



d. Count Three.

Figure 3-16.--Movements from Present Arms to Order Arms.

3. When a member of a color guard or when posted as a sentry, port arms, left or right shoulder arms may be executed from present arms.

a. Port arms is executed either without command or on the command of **"Port, ARMS."** It is executed in one count by rotating the rifle counterclockwise with the right hand as the grasp of the left hand is adjusted on the handguard to that of port arms.

b. Left shoulder arms from present arms is a three-count movement. The movement is executed without command or on the command(s) of **"Left Shoulder, ARMS;" "Carry, COLORS;"** or **"Shoulder, ARMS."** The first count is to rotate the rifle to port arms as described in paragraph 3111.3a. The next two counts are to move the rifle from port arms to the left shoulder as described in paragraph 3105.3.

c. Right shoulder arms from present arms is a four-count movement. The movement is executed without command or on the command(s) of **"Right Shoulder, ARMS;" "Carry, COLORS;"** or **"Shoulder, ARMS."** The first count is to rotate the rifle to port arms as described in paragraph 3111.3a. The next three counts are to move the rifle from port arms to the right shoulder as described in paragraph 3105.4.

#### 3112. RIFLE SALUTE

1. The purpose of this movement is to render a salute to persons or colors when not in formation nor posted as a sentry. It is a one-count movement executed when halted at order arms, trail arms, or when halted or marching at right or left shoulder arms. The command is **"Rifle, SALUTE"** and to terminate the salute the command is **"Ready, TWO."**

2. When at order arms, the left arm moves smartly across the body with the forearm and wrist straight, fingers extended and joined and palm down. The first joint of the forefinger touches the flash suppresser. When not in ranks, the head turns toward the person or colors saluted. (See figure 3-17a.) On **"Ready, TWO"** resume the position of attention.

3. When at trail arms, the movements are identical with those for saluting at order arms, except that the rifle is held in the trail arms position. (See figure 3-17b.)

4. At right (left) shoulder arms, the left (right) arm moves across the body, fingers extended and joined, and palm down. The first joint of the forefinger touches the rear of the receiver just below the charging handle, and the forearm is held parallel to the deck. (See figures 3-17c and d.) When not in ranks, the head and eyes turn toward the person or colors saluted. On **"Ready, TWO"** the position of attention is resumed.



a. Rifle Salute from Order Arms.



b. Rifle Salute from Trail Arms.



c. Rifle Salute from Right Shoulder Arms.



d. Rifle Salute from Left Shoulder Arms.

Figure 3-17.--Rifle Salutes.

3113. INSPECTION ARMS (WITH AND WITHOUT MAGAZINE)

1. The purpose of this movement is to inspect the rifle when in formation. Order arms to inspection arms is a seven-count movement and is executed when halted at order arms. The command is **"Inspection, ARMS."**

a. The first two counts are the same as the two-count movement from order arms to port arms. (See figures 3-18b and c.)

b. On the third count, release the grasp of the left hand from the handguard and re-grasp the pistol grip. The fingers are joined and grasping the pistol grip. At the same time, lace the thumb of the left hand over the lower portion of the bolt catch. (See figure 3-18d.)

c. On the fourth count, release the grasp of the right hand from the small of the stock and unlock the charging handle with the thumb and forefinger. The remaining three fingers are joined and placed on line with the forefinger just behind the charging handle. Sharply pull the charging handle to the rearmost position. At the same time, apply pressure to the bolt catch with the thumb of the left hand and lock the bolt to the rear. (See figure 3-18e.)

d. On the fifth count, push the charging handle forward until it is locked in its foremost position and grasp the small of the stock with the right hand. (See figure 3-18f.)

e. On the sixth count, elevate the rifle up and to the left rotating the rifle counterclockwise so that the chamber is visible. The ejection port will be at eye level. The right forearm will touch the stock and the weapon will be at approximately a 45-degree angle. At the same time, turn the head to the left and inspect the chamber to see that it is clean. (See figure 3-18g.)

f. On the seventh count, and after finding the chamber clear or clearing it, lower the rifle rotating it clockwise while turning the hand back to the front. Without loss of motion, release the grasp of the left hand from the pistol grip and re-grasp the handguard resuming the position of port arms. (See figure 3-18h.)

2. To execute inspection arms with the magazine in the weapon, remove the magazine with the left hand and place it between the clothing and the belt (left front) prior to count three.

3. Inspection arms may also be executed from right or left shoulder arms. For the first two counts the rifle is moved from the right (left) shoulder to port arms. The third through seventh counts then executed as described in paragraph 3113.1b through 3113.1f.



a. Start.



Count One.



Count Two.



b. Count Three.



c. Count Four.



d. Count Five.

Figure 3-18.--Inspection Arms from Order Arms.



e. Count Six.



f. Count Seven.

Figure 3-18.--Inspection Arms from Order Arms--Continued.

3114. PORT ARMS FROM INSPECTION ARMS (WITH AND WITHOUT MAGAZINE)

1. The purpose of this movement is to terminate inspection arms (rifle bolt locked to the rear). This is a one-count movement, however there are four steps to be accomplished following the preparatory command. It is executed when halted at inspection arms. The command is **"Port, ARMS."** It is the only command that may be given from inspection arms.

a. On the preparatory command of **"Port,"** release the grasp of the left hand from the handguard and re-grasp the weapon with the thumb and fingers, forming a "U" at the magazine well and trigger guard. Press the bolt catch and allow the bolt to go forward. With the fingertips, push upward and close the dust cover. Slide the left hand down and grasp the pistol grip. The fingers are joined and grasping the pistol grip. At the same time, place the thumb on the trigger so the tip of the thumb is outboard.

b. On the command of execution **"ARMS,"** pull the trigger with the thumb of the left hand. Then release the grasp of the left hand from the pistol grip and re-grasp the lower portion of the handguard resuming the position of port arms.

2. If inspection arms is executed with the magazine, it is returned to the weapon immediately after pulling the trigger and before resuming port arms.

3115. FIX AND UNFIX BAYONETS

1. The purpose of these movements is to attach and remove the bayonet while in formation. They are not precision movements, therefore, there are no counts. They are executed when halted at order arms.

2. To attach the bayonet to the rifle the command is "**Fix, BAYONETS.**"

a. On the command of execution, move the muzzle of the rifle to the left front and grasp the barrel with the left hand while keeping the pistol grip and magazine well pointed forward. With the right hand, unsnap the securing strap and withdraw the bayonet. Turn the point skyward and attach the bayonet to the weapon. While engaging the bayonet stud, with the base of the bayonet, grasp the handle and apply downward pressure until a click is heard. Apply limited upward pressure to ensure that the bayonet is seated securely.

b. Snap the scabbard, securing strap, and then resume the position of order arms.

3. To remove the bayonet from the rifle the command is "**Unfix, BAYONETS.**"

a. On the command of execution, move the muzzle to the left and grasp it with the left hand while keeping the pistol grip and magazine well pointed forward. With the right hand unsnap the securing strap. Release the bayonet from the bayonet stud and remove the bayonet from the muzzle. Keeping your eyes on the bayonet point, return it to the scabbard and insert it with the ring facing to the front.

b. Snap the scabbard securing strap and then resume order arms.

3116. AUTHORIZED MANUAL OF ARMS WITH THE M16 RIFLE

1. All of the following movements may be executed while halted. Those marked by an asterisk (\*) may be executed while halted or marching forward at quick time.

2. From Order Arms to

- a. Port Arms
- b. Right Shoulder Arms
- c. Left Shoulder Arms
- d. Present Arms
- e. Inspection Arms
- f. Trail Arms
- g. Rifle Salute
- h. Rest Positions
- i. Fix Bayonets
- j. Sling Arms

3. From Port Arms to
  - a. Right Shoulder Arms \*
  - b. Left Shoulder Arms \*
  - c. Order Arms
  - d. Present Arms
4. From Right Shoulder Arms to
  - a. Left Shoulder Arms \*
  - b. Port Arms \*
  - c. Order Arms
  - d. Present Arms
  - e. Inspection Arms
5. From Left Shoulder Arms to
  - a. Right Shoulder Arms \*
  - b. Port Arms \*
  - c. Order Arms
  - d. Present Arms
  - e. Inspection Arms
6. From Present Arms to
  - a. Order Arms
  - b. Port, Left or Right Shoulder Arms (When a member of a color guard, or when posted as a sentry)
7. From Inspection Arms to Port Arms only.



## CHAPTER 3

## MANUAL OF ARMS WITH THE M16 RIFLE

## SECTION 2: MANUAL OF ARMS WITH A LOOSENED SLING

3200. GENERAL

1. This Section contains the procedures for executing manual of arms movements with the sling loosened so that the rifle may be carried slung from the shoulder. This is known as the sling arms position.
2. All individual or unit drill movements may be executed while at sling arms, except stack arms and unfix and fix bayonets.
3. Remain at sling arms during all rest movements.
4. Stack arms and fix and unfix bayonets (slings loose) are executed from unsling arms (order arms) only.
5. When in formation at sling arms, execute the hand salute on the command **"Present, ARMS."**

3201. SLING ARMS1. From Order Arms

a. The purpose of this movement is to change from a parade sling to a loosened sling and to then sling the rifle onto the right shoulder. This is not a precision movement; therefore, there are no counts. From the order arms position (with a parade sling) the command for sling arms is **"Sling, ARMS."**

b. On the command of execution, slide the right hand up and grasp the barrel near the flash suppresser. Without loss of motion, raise the rifle vertically to a diagonal position where the butt is in front of the right hip with the muzzle pointing up and the pistol grip to the left. At the same time, grasp the rifle at the handguard just above the slipring with the left hand. The sling is included in the grasp. The fingers are joined. Place the butt on the right hip. Release the grasp of the right hand and with the left hand move the rifle so that it will rest on the inside of the right elbow and cradle it there. (See figure 3-19.) The muzzle points slightly to the right. Release the grasp of the left hand from the handguard and with both hands loosen the sling. After the sling has been loosened, grasp the sling with your left hand and sling the rifle on the right shoulder in the most direct manner. Re-grasp the sling with the right hand. With the exception of the right arm, return to the position of attention. The palm of the right hand is toward the sling. The fingers are joined. The fingers and thumb are wrapped around the sling with the knuckles forward. The wrist and forearm are straight and parallel to the deck. The elbow is holding the rifle in a vertical position and against the body. (See figure 3-20.)



Figure 3-19.--Cradle Rifle Inside Right Elbow.



Figure 3-20.--Position of Sling Arms.

## 2. From Unslung Arms

a. The purpose of this movement is to sling the rifle on the right shoulder when the sling has already been loosened. This is not a precision movement; therefore, there are no counts. From the unslung arms position (order arms with loosened sling), the command for sling arms is **"Sling, ARMS."**

b. On the command of execution, slide the right hand up and grasp the barrel near the flash suppresser. The fingers are joined and wrapped around the barrel with the thumb wrapped around the inboard portion. Without loss of motion, raise the rifle and grasp the sling with the left hand near the upper sling swivel. Release the grasp of the right hand and, with the left hand, sling the rifle over the right shoulder in the most convenient manner. Re-grasp the sling with the right hand. With the exception of the right arm, return to the position of attention. The palm of the right hand is toward the sling. The fingers are joined. The fingers and thumb of the right hand are wrapped around the sling with the knuckles forward. The wrist and forearm are straight and parallel to the deck. The elbow is holding the rifle in a vertical position and against the body.

### 3202. UNSLING ARMS

1. The purpose of this movement is to take the slung rifle off of the shoulder and move it to the order arms position. This is not a precision movement; therefore, there are no counts. It is executed when halted at sling arms. The command is **"Unslung, ARMS."**

2. On the command of execution, grasp the sling with the left hand in front of the armpit and unslung the rifle from the right shoulder in the most convenient manner. Grasp the rifle at the junction of the barrel and the front sight assembly. Release the grasp of the left hand from the sling and, with the right hand, carry the weapon to the right side until the butt is 3 inches from the deck. The barrel is in a vertical position. At the same time, guide the weapon with the left hand until the right thumb is on the trouser seam. The fingers of the left hand are extended and joined and touching the rifle, near the flash suppresser. The palm of the left hand is toward the rear. The left wrist and forearm are straight and the left elbow is in against the body. Quietly lower the rifle to the deck with the right hand and at the same time return the left hand to the left side at the position of attention.

### 3203. ADJUST SLINGS

1. The purpose of this movement is to change a loosened sling to parade sling. This is not a precision movement; therefore, there are no counts. The command is **"Adjust, SLINGS."**

2. From unslung arms (order arms); on the command of execution, the rifle is brought to a cradle position inside the right elbow as in the movement from order arms to sling arms. While in this position, the sling is tightened to parade sling. The rifle is then returned to order arms.

3. From sling arms, on the command of execution, grasp the sling with the left hand in front of the armpit and unslung the rifle from the right shoulder in the most convenient manner. Then place the butt on the right hip and cradle the rifle inside the right elbow. Tighten the sling to the parade sling position and automatically assume the position of order arms.

3204. SALUTING AT SLING ARMS

1. The purpose of this movement is to render a salute while at sling arms. It is a two-count movement and is executed when halted at sling arms. The command is **"Present, ARMS."**
2. On the command of execution and for the count of one, reach across the body with the left hand and grasp the sling just above the right hand. On the second count, release the right hand and execute the hand salute. (See figure 3-21.)
3. To resume order arms, the command is **"Order, ARMS."** On the command of execution lower the right hand smartly to the right side and re-grasp the sling at the original position. After grasping the sling with the right hand, release the sling with the left hand and return it smartly to the position of attention.



a. Count One.



b. Count Two.

Figure 3-21.--Salute at Sling Arms.

3205. PORT ARMS FROM SLING ARMS

1. The purpose of this movement is take the rifle off of the shoulder and move it to the position of port arms. This is not a precision movement; therefore there are no counts. It is executed when halted at the position of sling arms. The command is "**Port, ARMS.**"

2. On the command of execution, reach across the body with the left hand and grasp the sling at the shoulder. Lift the weapon (by the sling), swing it to the front of the body, and grasp the small of the stock with the right hand. Release the sling and re-grasp the weapon just forward of the slipring with the left hand. Keep the elbows into the side with the right forearm horizontal. (See figure 3-22.)



a. Start.



b. Grasping the Sling.

Figure 3-22.--Port Arms from Sling Arms.



c. Weapon off Shoulder.



d. Port Arms.

Figure 3-22.--Port Arms from Sling Arms--Continued.

3. To resume sling arms, the command is **"Sling, ARMS."** On the command of execution, grasp the sling near the upper-sling swivel with the left hand. Release the right hand and swing the weapon back onto the shoulder by inserting the right arm through the sling, immediately resuming the position of sling arms.

#### 3206. INSPECTION ARMS FROM SLING ARMS

1. The purpose of this movement is to inspect the rifle when at sling arms. This is not a precision movement; therefore there are no counts. It is executed when halted at sling arms. The command is **"Inspection, ARMS."**

2. On the command of execution, move the left arm across the body and grasp the rifle by the pistol grip and place the thumb on the lower part of the bolt catch. (See figure 3-23b.) Release the grasp on the sling and, with the left hand and arm supporting the weapon, bring the rifle to a position diagonally across the body, placing the right hand at the small of the stock. (See figure 3-23c.) Unlock the charging handle with the thumb and pull it to the rear. (See figure 3-23d.) Push the charging handle until it is locked in its foremost position and grasp the small of the stock with the right hand. Elevate the rifle up and to the left, at the same time rotating it 90 degrees so that the handgrip is pointing away from the body. At this time, visually inspect the chamber to see that it is clear. (See figure 3-23e.) Return to port arms. (See figure 3-23f.)



a. Start.



b. To the Pistol Grip.



c. Diagonal Across Body.



d. Charging Handle.



e. Inspecting Chamber.



f. Port Arms.

Figure 3-23.--Inspection Arms from Sling Arms.





## CHAPTER 3

## MANUAL OF ARMS WITH THE M16 RIFLE

## SECTION 3: MANUAL OF ARMS MOVEMENTS WITH THE M203

3300. GENERAL

1. This Section contains the procedures for executing manual of arms movements with the M203 Grenade Launcher.
2. When it is necessary to conduct a drill or ceremony involving troops armed with the M203, they will carry the weapon at sling arms. (See figure 3-24.)
3. The M203 will always be rigged with a loosened sling.
4. Troops armed with the M203 will fall in at sling arms and execute all individual drill movements from that position. The only manual of arms movements they will execute are present arms (hand salute) and inspection arms.
5. If stack arms is to be given, troops armed with the M203 will be positioned in ranks so that their weapons are treated as extras on the stacks.



a. Front.



b. Right Side.

Figure 3-24.--Sling Arms with the M203.

3301. PRESENT ARMS WITH THE M203

1. When armed with the M203, present arms will be executed in the same manner as the salute while at sling arms with the M16. (See figure 3-21.)
2. Sling arms will be resumed when order arms is given.

3302. INSPECTION ARMS WITH THE M203

1. The purpose of this movement is to inspect the M203 while in formation. This is not a precision movement; therefore, there are no counts. It is executed when halted at sling arms. The command is **"Inspection, ARMS."**

a. On the command of execution, the initial movements are the same as inspection arms from sling arms with the M16. (See figure 3-23.)

b. When at the inspection arms position for the M16, continue with the M203 by pressing the barrel latch and sliding the barrel up to the barrel stop. Elevate the M203 again, turning the head and eyes, visually inspect the chamber of the barrel. Return to a modified port arms position with the left hand holding the barrel at its full forward position. (See figure 3-25.)



a. Grasp Pistol Grip.



b. Grasp Small of Stock.



c. Pull Charging Handle.



d. Re-grasp Stock.



e. Inspect Chamber.

Figure 3-25.--Inspection Arms with the M203.



f. Grasp Barrel Release. g. Open 203 Barrel. h. Left Hand to Port. i. Inspecting M203 Barrel. j. Final Position.

Figure 3-25.--Inspection Arms with the M203--Continued.

2. The command to return to the sling arms position from inspection arms is **"Port, ARMS."**

a. On the preparatory command **"Port,"** slide the barrel down to its closed and latched position. Then continue to close the bolt and dust cover and slide the left hand down to grasp the pistol grip and place the thumb on the rifle trigger as with the M16.

b. On the command of execution **"ARMS,"** pull the rifle trigger with the thumb of the left hand and then move it to the trigger of the grenade launcher and pull that trigger. Return to sling arms.

MARINE CORPS DRILL AND CEREMONIES MANUAL

PART I: DRILL

CHAPTER 4

MANUAL OF ARMS WITH THE HANDGUN

	<u>PARAGRAPH</u>	<u>PAGE</u>
GENERAL . . . . .	4000	4-3
PRESENT ARMS WITH PISTOL IN HOLSTER . . . . .	4001	4-4
ORDER ARMS FROM PRESENT ARMS WITH PISTOL IN HOLSTER . . . . .	4002	4-4
INSPECTION ARMS WITH PISTOL IN HOLSTER . . . . .	4003	4-4
PORT ARMS FROM INSPECTION ARMS (PISTOL RETURNED TO HOLSTER) .	4004	4-9

FIGURE

4-1	M9 SERVICE PISTOL . . . . .	4-3
4-2	POSITION OF ATTENTION ARMED WITH PISTOL . . . . .	4-4
4-3	PISTOL REMOVED FROM THE HOLSTER TO ITS VERTICAL POSITION . . . . .	4-5
4-4	PISTOL ROTATED WHILE REMOVING THE MAGAZINE (RIGHT HANDED) . . . . .	4-6
4-5	PISTOL ROTATED WHILE REMOVING THE MAGAZINE (LEFT HANDED) . . . . .	4-6
4-6	SLIDE TO REAR (RIGHT HANDED) . . . . .	4-7
4-7	SLIDE TO REAR (LEFT HANDED). . . . .	4-8
4-8	POSITION OF INSPECTION ARMS (RIGHT HANDED) . . . . .	4-8
4-9	POSITION OF INSPECTION ARMS (LEFT HANDED) . . . . .	4-9



PART I: DRILL

CHAPTER 4

MANUAL OF ARMS WITH THE HANDGUN

4000. GENERAL

1. The manual of arms with the handgun is executed with the M9 service pistol. When executing the manual the pistol will be in condition 4 except when executing **"Port, ARMS"** from **"Inspection, ARMS."** Figure 4-1 shows the nomenclature of the M9 pistol.
2. When in ranks and armed with the pistol, all movements with the exception of inspection arms are executed as if unarmed. The manual of arms for the pistol will be executed with the lanyard attached.
3. The manual of arms for the pistol is not executed in cadence. It is a simple, quick, and safe method of handling the weapon.
4. The manual of arms with the pistol may be executed with the weapon holstered on either the right or left side.
5. When in formation, remain at attention during all rifle manual movements except those listed below.

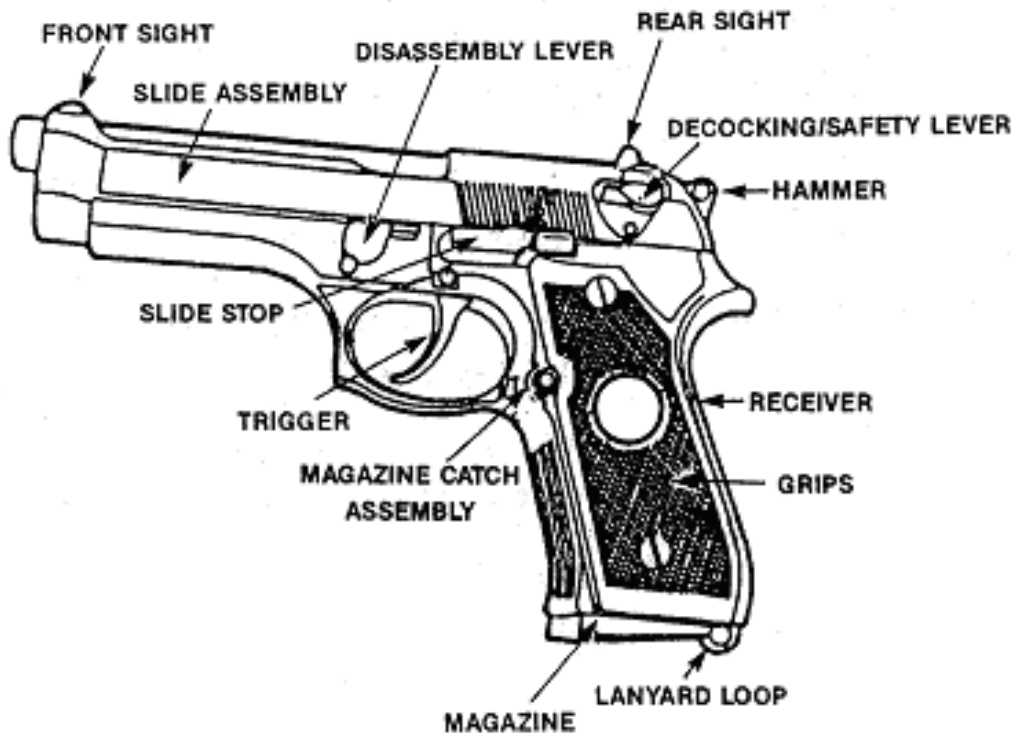

Figure 4-1.--M9 Service Pistol.

4001. PRESENT ARMS WITH PISTOL IN HOLSTER

1. The command is "**Present, ARMS.**" It is executed in one count.
2. On the command of execution, "**ARMS,**" execute the hand salute.

4002. ORDER ARMS FROM PRESENT ARMS WITH PISTOL IN HOLSTER

1. The command is "**Order, ARMS.**" it is executed in one count.
2. On the command of execution, "**ARMS,**" smartly return the right hand to its normal position on the right side.

4003. INSPECTION ARMS WITH PISTOL IN HOLSTER

1. The command is "**Inspection, ARMS.**" It involves several movements THAT are executed rapidly and smartly without count. It may be executed only when halted at attention with pistol in holster. (See figure 4-2.) Inspection arms is not executed with the pistol as part of the rifle manual except when the unit is formed and dismissed.

NOTE: If holstered on the left side, the opposite hands are used from those described below.



a. Right Handed.



B. Left Handed.

Figure 4-2.--Position of Attention Armed with Pistol.

2. On **"ARMS,"** with the right (left) thumb, unfasten the holster flap, grasp the grip and pull the pistol from the holster. Raise the right (left) hand to a position level with and approximately 6 inches in front of the right (left) shoulder. Disconnect the lanyard. The grip should be held between the thumb and last three fingers, forefinger extended and positioned alongside the trigger guard. The muzzle points forward and up at an angle of 30 degrees. (See figure 4-3.)



a. Right Handed.



b. Left Handed.

Figure 4-3.--Pistol Removed from the Holster to its Vertical Position.

### 3. Magazine Removal

a. Right Handed. Without lowering the muzzle or the right hand, turn the pistol handle to the left, look at the pistol, press the magazine catch with the right thumb and remove the magazine with the left hand. (See figure 4-4.) Turn the handle back to the right so that the bottom of the magazine well is to the front. Place the magazine at the left front hip between the pistol belt and outer garment with the magazine follower facing down.

b. Left Handed. Without lowering the muzzle or the left hand, turn the pistol handle to the right, look at the pistol, press the magazine catch with the left forefinger and remove the magazine with the right hand. (See figure 4-5.) Turn the handle back to the left so that the bottom of the magazine well is to the front. Place the magazine at the right front hip between the pistol belt and outer garment with the magazine follower facing down.





Figure 4-4.--Pistol Rotated while Removing the Magazine (Right Handed).



Figure 4-5.--Pistol Rotated while Removing the Magazine (Left Handed).

#### 4. Engaging the Slide Catch/Inspecting the Chamber

a. Right Handed. Without lowering the muzzle or the right hand, grasp the slide with the thumb and fingers of the left hand, thumb on the left side of the slide and pointing downward. Keep the left forearm parallel with the deck. Pull the slide all the way to the rear and engage the slide stop in its notch with the right thumb. (See figure 4-6.) Inspect the chamber to ensure a fully unloaded weapon. Smartly return the left hand to the left side assuming the position of attention. (See figure 4-8.)



Figure 4-6.--Slide to Rear (Right Handed).

b. Left Handed. Without lowering the muzzle or the left hand, grasp the slide with the thumb and fingers of the right hand, thumb on the right side of the slide and pointing downward. Keep the right forearm parallel with the deck. Pull the slide all the way to the rear and engage the slide stop in its notch with the right finger. (See figure 4-7.) Inspect the chamber to ensure a fully unloaded weapon. Smartly return the right hand to the right side assuming the position of attention. (See figure 4-9.)



Figure 4-7.--Slide to Rear (Left Handed).



Figure 4-8.--Position of Inspection Arms (Right Handed).



Figure 4-9.--Position of Inspection Arms (Left Handed).

4004. PORT ARMS FROM INSPECTION ARMS (PISTOL RETURNED TO HOLSTER)

1. The command is "**Port, ARMS**" and "**Order, ARMS.**" It is the only command that may be executed from inspection arms. If the pistol is holstered on the left side, the opposite hands are used from those described below.

a. On the command "**Port,**" with the thumb of the right (left) hand release the slide stop. With the muzzle pointing at a 30-degree angle, on the command "**ARMS,**" squeeze the trigger.

NOTE: If the weapon is on safe (condition 3), move the selector switch to fire (condition 1).

b. On the preparatory command "**Order,**" remove the magazine from the pistol belt and insert it back into the magazine well. Re-attach the lanyard to the lanyard ring.

c. On the command "**ARMS,**" return the pistol to the holster and fasten the flap with the right (left) thumb.

d. If the command "**DISMISSED**" is given, pistols will be holstered prior to exiting ranks.

MARINE CORPS DRILL AND CEREMONIES MANUAL

PART I: DRILL

CHAPTER 5

SWORD MANUAL

	<u>PARAGRAPH</u>	<u>PAGE</u>
GENERAL . . . . .	5000	5-3
DRAW SWORD . . . . .	5001	5-8
PRESENT SWORD FROM CARRY OR ORDER SWORD . . . . .	5002	5-11
ORDER SWORD FROM PRESENT SWORD . . . . .	5003	5-13
CARRY SWORD FROM ORDER SWORD OR PRESENT SWORD . . . . .	5004	5-14
EYES RIGHT (LEFT) FROM CARRY OR ORDER SWORD . . . . .	5005	5-15
PARADE REST FROM ORDER SWORD . . . . .	5006	5-17
AT EASE FROM ANY POSITION OF THE SWORD . . . . .	5007	5-18
REST FROM ANY POSITION OF THE SWORD . . . . .	5008	5-18
TO RETURN TO ATTENTION . . . . .	5009	5-19
RETURN SWORD FROM CARRY OR ORDER SWORD . . . . .	5010	5-19
FUNERAL CARRY . . . . .	5011	5-22
SWORD MOURNING KNOT . . . . .	5012	5-23
CARRY OF THE SWORD AND SCABBARD UNRIGGED . . . . .	5013	5-24
MARCHING AT DOUBLE TIME WHEN ARMED WITH THE SWORD . . . . .	5014	5-24
PUBLISH THE ORDER . . . . .	5015	5-25
FORMING AN ARCH OF SWORDS FOR WEDDINGS . . . . .	5016	5-26
PASSING AN UNSHEATHED SWORD . . . . .	5017	5-28

FIGURE

5-1	MARINE OFFICER'S SWORD. . . . .	5-4
5-2	NONCOMMISSIONED OFFICER'S SWORD . . . . .	5-6
5-3	MOVEMENTS TO DRAW SWORD FOR OFFICERS . . . . .	5-9
5-4	MOVEMENTS TO DRAW SWORD FOR NONCOMMISSIONED OFFICERS.	5-10

MARINE CORPS DRILL AND CEREMONIES MANUAL

	<u>PAGE</u>
5-5      MOVEMENTS FOR PRESENT SWORD FROM CARRY OR ORDER SWORD; OFFICERS . . . . .	5-11
5-6      MOVEMENTS FOR PRESENT SWORD FROM CARRY OR ORDER SWORD; NONCOMMISSIONED OFFICERS . . . . .	5-12
5-7      ORDER SWORD FROM PRESENT SWORD; OFFICERS . . . . .	5-13
5-8      ORDER SWORD FROM PRESENT SWORD; NONCOMMISSIONED OFFICERS . . . . .	5-14
5-9      EYES RIGHT (LEFT) FROM CARRY OR ORDER SWORD; OFFICERS	5-15
5-10     EYES RIGHT (LEFT) FROM CARRY OR ORDER SWORD; NONCOMMISSIONED OFFICERS . . . . .	5-15
5-11     PARADE REST FROM ORDER SWORD; OFFICERS . . . . .	5-17
5-12     PARADE REST FROM ORDER SWORD; NONCOMMISSIONED OFFICERS	5-17
5-13     AT EASE . . . . .	5-18
5-14     MOVEMENTS FOR RETURN SWORD FROM CARRY OR ORDER SWORD; OFFICERS . . . . .	5-19
5-15     MOVEMENTS FOR RETURN SWORD FROM CARRY OR ORDER SWORD; NONCOMMISSIONED OFFICERS . . . . .	5-21
5-16     FUNERAL CARRY . . . . .	5-22
5-17     THE SWORD MOURNING KNOT . . . . .	5-23
5-18     UNRIGGED CARRY . . . . .	5-24
5-19     DOUBLE TIME ARMED WITH A SWORD . . . . .	5-25
5-20     PUBLISH THE ORDER . . . . .	5-26
5-21     FORMATION FOR THE ARCH OF SWORDS . . . . .	5-27
5-23     PASSING AN UNSHEATHED SWORD . . . . .	5-28

MARINE CORPS DRILL AND CEREMONIES MANUAL

PART I: DRILL

CHAPTER 5

SWORD MANUAL

5000. GENERAL

1. Authorization for use of the sword.

a. The Marine officers (Mameluke) sword is authorized for use by all Marine commissioned and warrant officers at parades, reviews, and other ceremonies.

b. The Marine noncommissioned officer's sword is authorized for use by all enlisted Marines in the grade of corporal through sergeant major for parades, reviews, and other ceremonies. Marines in the grade of lance corporal through private may be trained in the use of the sword for motivational purposes. However, the use of the noncommissioned officer sword by Marines in the grade of lance corporal and below for parades, reviews or other ceremonies is expressly forbidden.

c. Color guards mounted on horseback may be armed with the noncommissioned officer sword in lieu of rifles or pistols. All members of the color guard need to be a noncommissioned officer and/or staff noncommissioned officer. No other color guards will be armed with swords.

d. Officers, staff noncommissioned officers and noncommissioned officers may be armed with the appropriate sword while filling duty assignments when the commander deems it appropriate to have Marines armed with the sword as a symbol of leadership or authority.

e. A Marine is considered under arms when armed with the sword when the sword is rigged even when not in a duty status. This is because a sword is a ceremonial weapon.

f. The wearing of swords during ceremonies while in the utility uniform is not authorized. Marine Corps uniform regulations prescribe the appropriate uniforms for wear when armed with a sword. However, for instructional purposes, unit leaders may authorize the wear of swords while in the utility uniform during rehearsals and when conducting unit training in sword manual. This provision also applies to sword manual training at all professional military education schools.

2. Drill movements with the sword are made with a fluid, deliberate motion. Trying to "snap" or "whip" the sword will usually result in the execution of the movement seeming to be awkward or ragged. Officers and noncommissioned officers execute the sword manual in the same manner with the following exceptions:

a. The officer's scabbard is rotated to draw or return sword. The Marine officer's scabbard is worn with the convex edge to the rear (see figure 5-1), except when rotated 180-degrees to draw or return sword.

b. The noncommissioned officer's scabbard is attached to a frog that prevents it from rotating. It is worn with the convex edge to the front and remains in that position during draw and return sword. (See figure 5-2.)

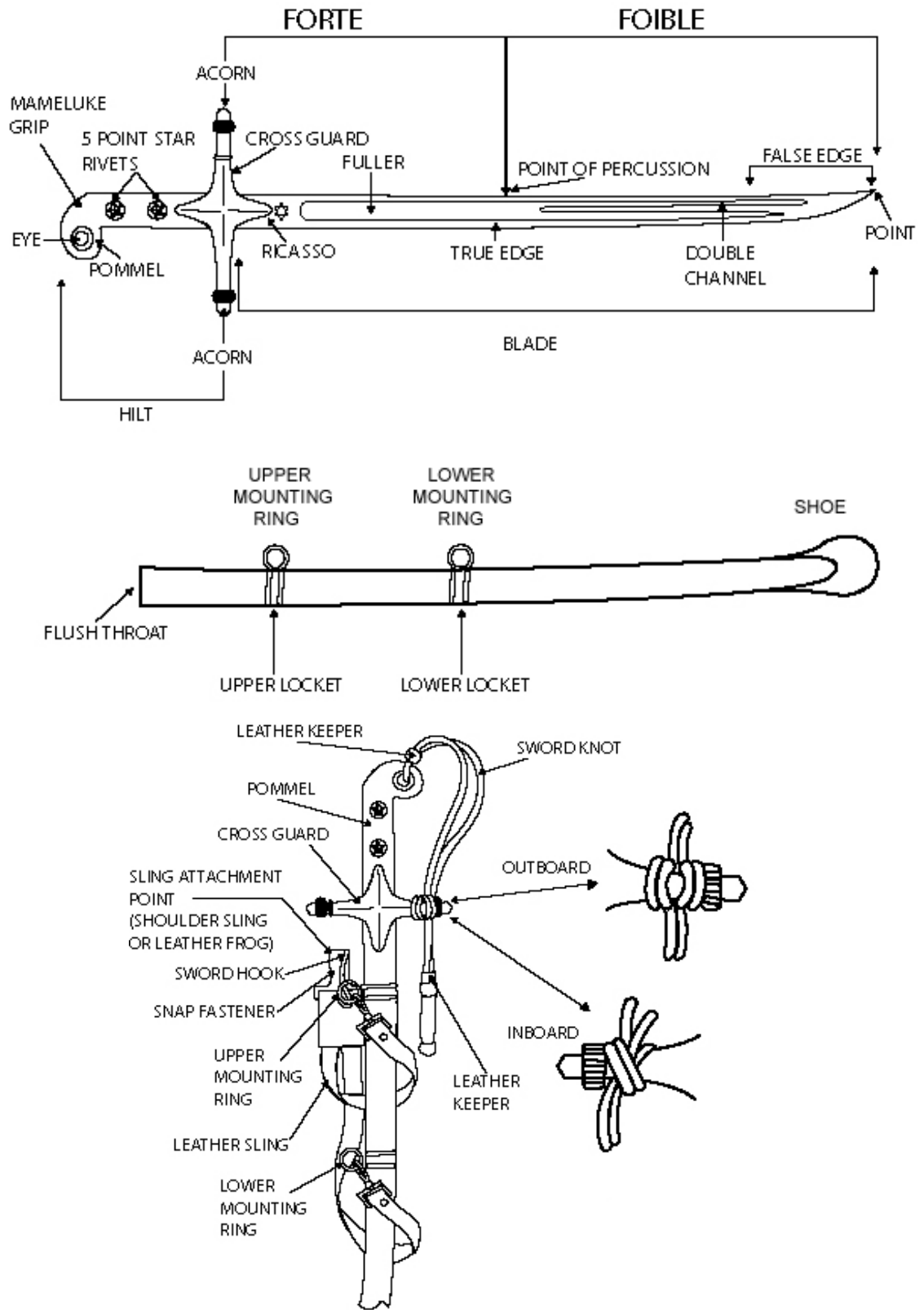

a. Nomenclature.

Figure 5-1.--Marine Officer's Sword.





b. Front.



c. Left Side.



d. Properly Worn.

Figure 5-1.--Marine Officer's Sword--Continued.

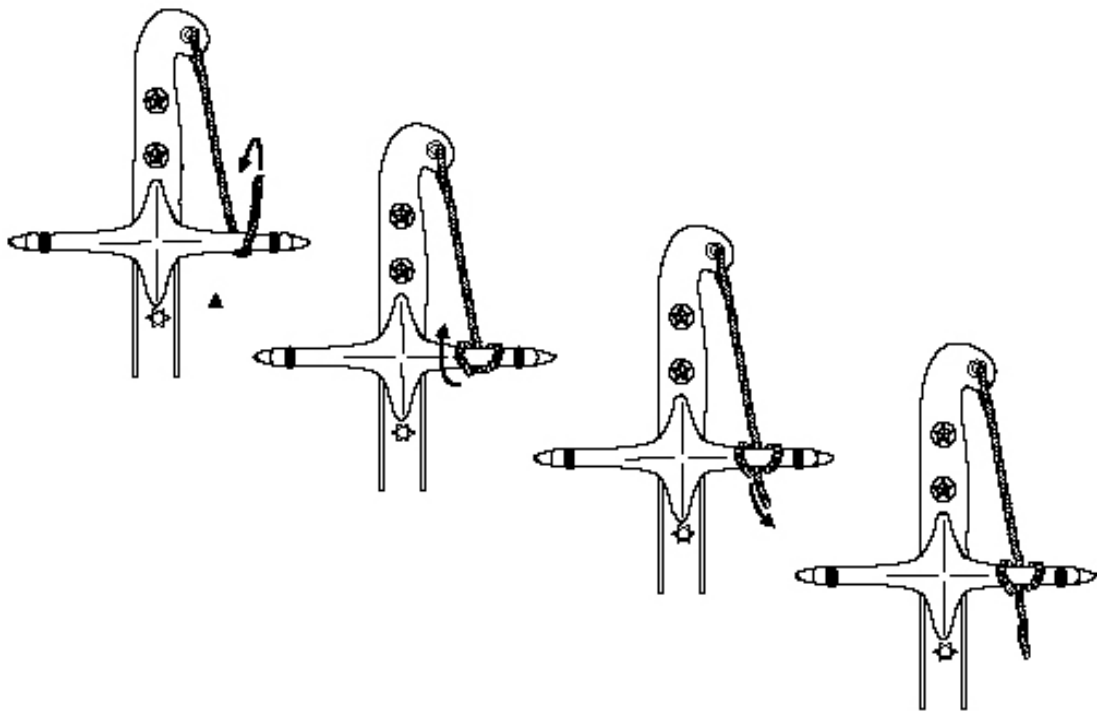

e. Sword Knot.

Figure 5-1.--Marine Officer's Sword--Continued.

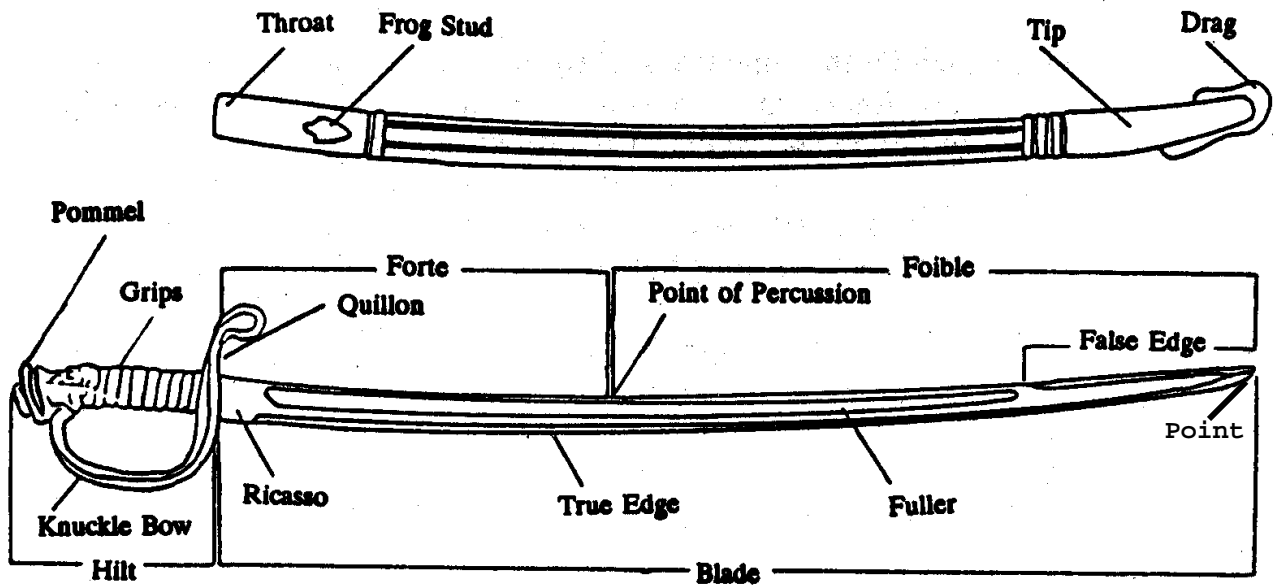

a. Nomenclature.

Figure 5-2.--Noncommissioned Officer's Sword.



b. Front.



c. Left Side.

Figure 5-2.--Noncommissioned Officer's Sword--Continued.

3. Officers and noncommissioned officers draw and return sword, without command, when the commander of their unit does. Unless members of the commander's staff, they execute all other movements of the sword manual on the commander's command to the unit. Staff members execute all other movements on the commander's separate command to his staff. The sword will be drawn with armed troops, except when at ease, rest, route step, at ease march, or when inspecting troops. A unit commander, after being inspected, will return sword prior to accompanying the inspecting party, except during the inspection of an honor guard.

4. Carry Sword is Assumed When

- a. Giving commands.
- b. Changing position in formation at quick time.

- c. Addressing or being addressed by a senior (except when saluting).
- d. The preparatory command for any quick time marching movement has been given.
- e. Marching at quick time.
- f. Company officers and noncommissioned officers go to carry sword when any manual of arms movement has been ordered except parade rest, at ease, rest, present arms, or eyes right (left)(organization staffs excluded).
- g. In formation with personnel to your front at normal distance or less (organization staffs excluded), remain at carry sword except during rest or at ease.
- h. Commander's staff, to include the staffs of subordinate commanders at regimental/group or larger size units, go to carry sword only when changing position, marching at quick time (e.g., boxing the staff) or on the order of the commander to carry sword prior to marching in review.

5. Present Sword is Assumed When

- a. Saluting with the sword.
  - b. The unit is presented to the colors or any person, or when the "National Anthem," "To the Color," "Retreat," "Hail to the Chief," memorial "Taps" or other musical honors to flag and general officers is played.
  - c. Executing eyes right (left) while marching past a reviewing officer or stand. If in the interior or rear of a formation, remain at carry sword.
6. Marching with sword at the carry, both arms should swing 6 inches to the front and 3 inches to the rear. Do not hold the scabbard or sling. The exception to this is during eyes right (left) while on the march the right arm is held straight at the side and the sword is kept from moving.
7. Not in formation, keep the sword in its scabbard. Salute by executing the hand salute.

5001. DRAW SWORD

- 1. The command is "**Draw, SWORD.**"
- 2. On the Preparatory Command "Draw"

a. Officers. Grip the scabbard below the upper brass mounting ring with the left hand. Turn it clockwise 180 degrees. Tilt it forward to form an angle of 45 degrees with the deck. At the same time, reach across the body and grasp the sword grip with the right hand; draw the sword approximately 6 inches from the scabbard until the right wrist and forearm are straight and parallel to the deck. The left hand holds the scabbard against the side. (See figures 5-3a and b.)

Enclosure (1)



a. Front View on "Draw."



b. Side View on "Draw."



c. Front View of First Step of Execution.



d. Side View of First Step of Execution.



e. Front View of Position of Carry Sword.



f. Side View of Carry Sword.

Figure 5-3.--Movements to Draw Sword for Officers.

b. Noncommissioned Officers. Grip the scabbard just below the frog with the left hand. Tilt it forward to form an angle of 45 degrees with the deck. At the same time, reach across the front of the body and grasp the sword grip with the right hand; draw the sword about 10 inches from the scabbard until the right wrist and forearm are straight and parallel to the deck. The left hand holds the scabbard against the side. (See figures 5-4a and b.)



a. Front View on "Draw."



b. Side View on "Draw."



c. Front View of First Step of Execution.



d. Side View of First Step of Execution.



e. Front View of Position of Carry Sword.



f. Side View of Position of Carry Sword.

Figure 5-4.--Movements to Draw Sword for Noncommissioned Officers.

### 3. On The Command of Execution "SWORD"

a. Draw the sword smartly, raising the right arm to its full extent, directly to the front at an angle of about 45 degrees, the sword in a straight line with the arm, true edge down; drop the left hand to the side. (Officers see figures 5-3c and d; noncommissioned officers see figures 5-4c and d.)

b. Pause for one count.

c. Bring the false edge of the blade against the shoulder seam, blade vertical, back of the grip to the rear, and the arm nearly extended. The right thumb and forefinger embrace the lower part of the grip, with the thumb against the trouser seam, and the remaining fingers joined in a natural curl behind the end of the hilt as if holding a pen or pencil. This is the position of carry sword. (Officers see figures 5-3e and f; noncommissioned officers see figures 5-4e and f.)

5002. PRESENT SWORD FROM CARRY OR ORDER SWORD

1. The command is **"Present, SWORD (ARMS)."** It may be given only when halted at order sword or carry sword. It is executed in two counts.
2. On **"Present,"** raise the right hand to the level of and 6 inches in front of the neck. Keep the thumb on the left side of the grip, wrist slightly bent, and inner forearm against the body. The blade should incline forward at a 30-degree angle from vertical. (Officers see figures 5-5a and b; noncommissioned officers see figures 5-6a and b.)
3. On **"SWORD (ARMS),"** bring the point down smartly, without whipping, to a position 3 inches above the deck and slightly right of the right foot. Straighten the arm so the knuckle bow (noncommissioned officers) or the acorn (officers) is against the trouser seam. The blade is inclined down and to the front with the true edge to the left. The thumb remains on the left side of the grip. (Officers see figures 5-5c and d; noncommissioned officers see figures 5-6c and d.)
4. When at carry or order sword and it becomes necessary to salute without command, execute present sword. After the salute has been returned, go to order sword (then to carry sword if walking).



a. On Command **"Present"** (Front).



b. On Command **"Present"** (Side).

Figure 5-5.--Movements for Present Sword from Carry or Order Sword; Officers.



c. Present Sword, Front View.



d. Present Sword, Side View.

Figure 5-5.--Movements for Present Sword from Carry or Order Sword; Officers--Continued.



a. On Command "Present" (Front).



b. On Command "Present" (Side).

Figure 5-6.--Movements for Present Sword from Carry or Order Sword; Noncommissioned Officers.





c. Present Sword, Front View.



d. Present Sword, Side View.

Figure 5-6.--Movements for Present Sword from Carry or Order Sword;  
Noncommissioned Officers--Continued.

5003. ORDER SWORD FROM PRESENT SWORD

1. The command is "**Order, SWORD (ARMS).**" It is executed in one count.
2. On "**SWORD (ARMS),**" turn the true edge down. In this position, the right arm hangs naturally with the thumb along the trouser seam. The blade slants down to the front with the point 3 inches from the deck. (Officers see figure 5-7, noncommissioned officers see figure 5-8.)



a. Present Sword.



b. Order Sword, Front.



c. Order Sword, Side.

Figure 5-7.--Order Sword from Present Sword; Officers.



a. Present Sword.

b. Order Sword, Front.

c. Order Sword, Side.

Figure 5-8.--Order Sword from Present Sword; Noncommissioned Officers.

5004. CARRY SWORD FROM ORDER SWORD OR PRESENT SWORD

1. The command is **"Carry, SWORD"** it may be given only when halted at order sword or present sword. Company officers and noncommissioned officers would also execute carry sword when the unit is given any manual of arms movement (e.g., port, left/right shoulder arms).

2. When at order sword and the command **"Carry, SWORD"** is given. On the command of execution **"SWORD,"** bring the false edge of the blade against the shoulder seam, blade vertical, back of the grip to the rear, and the arm nearly extended. The right thumb and forefinger embrace the lower part of the grip, with the thumb against the trouser seam, and the remaining fingers joined in a natural curl behind the end of the hilt. This is the position of carry sword. (Officers see figures 5-3e and f; noncommissioned officers see figures 5-4e and f.)

3. When at present sword and the command of **"Carry, SWORD"** is given.

a. On the preparatory command of **"Carry,"** turn the true edge down. In this position, the right arm hangs naturally with the thumb along the trouser seam. The blade slants down to the front with the point 3 inches from the deck. (Officers see figures 5-7b and c; noncommissioned officers see figures 5-8b and c.)

b. On the command of execution **"SWORD,"** bring the false edge of the blade against the shoulder seam, blade vertical, back of the grip to the rear, and the arm nearly extended. The right thumb and forefinger embrace the lower part of the grip, with the thumb against the trouser seam, and the remaining fingers joined in a natural curl behind the end of the hilt. This is the position of carry sword. (Officers see figures 5-3e and f; noncommissioned officers see figures 5-4e and f.)

5005. EYES RIGHT (LEFT) FROM CARRY OR ORDER SWORD

1. General Information. The command is "**Eyes, RIGHT (LEFT).**" It may be given when halted at order sword or when marching at carry sword. It is executed in two counts.

2. Eyes Right (Left) While Halted

a. On "**Eyes,**" raise the right hand to the level of and 6 inches in front of the neck. Keep the thumb on the left side of the grip, wrist slightly bent, and inner forearm against the body. The blade should incline forward at a 30-degree angle from vertical. This movement is the same as that made on the preparatory command of "**Present.**" (Officers see figure 5-5; noncommissioned officers see figure 5-6.)

b. On "**RIGHT (LEFT),**" bring the point down smartly, without whipping, to a position 3 inches above the deck and slightly right of the right foot. Straighten the arm so the knuckle bow (noncommissioned officers) or the acorn (officers) is against the trouser seam. The blade is slanted down and to the front, with the true edge to the left. The thumb remains on the left side of the grip. At the same time, turn the head and eyes 45 degrees to the right (left). If in extreme right (left) file, continue looking straight ahead. (Officers see figure 5-9; noncommissioned officers see figure 5-10.)



Figure 5-9.--Eyes Right (Left) from Carry or Order Sword; Officers.

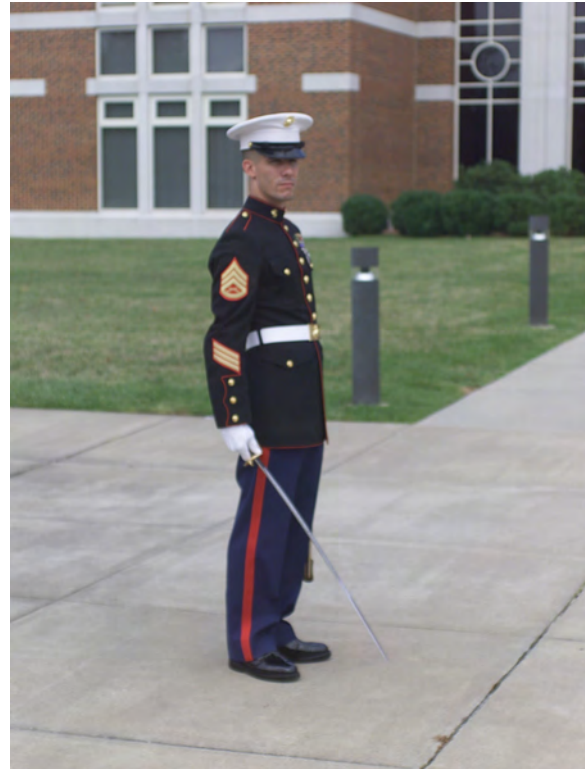

Figure 5-10.--Eyes Right (Left) from Carry or Order Sword; Noncommissioned Officers.

- 3. Order Sword From Eyes Right (Left) (Executed While Halted). As the reviewing party passes, follow with your head and eyes until you are looking directly to the front and then execute order sword.

Enclosure (1)

4. Eyes Right (Left) While Marching

- a. The command is **"Eyes, RIGHT."**
- b. The preparatory command **"Eyes"** is given as the right foot strikes the deck.
- c. As the left foot strikes the deck raise the right hand to the level of and 6 inches in front of the neck. Keep the thumb on the left side of the grip, wrist slightly bent, and inner forearm against the body. The blade should incline forward at a 30-degree angle from vertical. This movement is the same as that made on the preparatory command of **"Present."** (Officers see figure 5-5a; non-commissioned officers see figure 5-6a.) The left arm continues to swing naturally.
- d. The command of execution **"RIGHT"** is given as the right foot strikes the deck.
- e. As the left foot strikes the deck bring the point down smartly, without whipping, to a position 3 inches above the deck and slightly right of the right foot. Straighten the arm so the knuckle bow (noncommissioned officers) or the acorn (officers) is against the trouser seam. The blade is slanted down and to the front, with the true edge to the left. The thumb remains on the left side of the grip. At the same time, turn the head and eyes 45 degrees to the right. If in extreme right file, continue looking straight ahead. (Officers see figure 5-9; noncommissioned officers see figure 5-10.) The right arm does not swing. The left arm continues to swing naturally.
- f. To execute eyes left while marching, use the above sequence substituting left for right and right for left.

5. Carry Sword from Eyes Right (Left) (Executed When On The March)

- a. The command is **"Ready, FRONT."** Execution is begun on the preparatory command.
- b. The preparatory command **"Ready"** is given as the left foot strikes the deck.
- c. As the right foot strikes the deck turn the true edge of the sword down.
- d. The command of execution **"FRONT"** is given as the left foot strikes the deck.
- e. As the right foot strikes the deck raise the sword to carry. At the same time, turn the head and eyes to the front.
- f. The best way to remember the movements of the sword when executing eyes right and ready front while marching is:

Foot	RIGHT	LEFT	RIGHT	LEFT	RIGHT	LEFT	RIGHT	LEFT
Command	<b>"Eyes,</b>	(UP)	<b>RIGHT"</b>	(DOWN)	<b>"Ready,</b>	(DOWN)	<b>FRONT"</b>	(UP)

Enclosure (1)

5006. PARADE REST FROM ORDER SWORD

1. The command is **"Parade, REST."** This command is normally given from order sword, in which case it is executed in one count.
2. If given when at carry sword, go to order sword on the command of **"Parade."**
3. On **"REST,"** move the left foot smartly 12 inches to the left. At the same time, lower the point of the sword to the deck, place the left hand behind you, just below the belt. (Officers see figure 5-11, noncommissioned officers see figure 5-12.)



a. Front View.



b. Side View.

Figure 5-11.--Parade Rest from Order Sword; Officers.



a. Front View.



b. Side View.

Figure 5-12.--Parade Rest from Order Sword; Noncommissioned Officers.

#### 4. Order Sword From Parade Rest

a. The command is "**Platoon (Company or Detail), ATTENTION.**" It is executed in one count.

b. On "**ATTENTION,**" bring the left heel smartly against the right and the left hand back to the side. Raise the blade so the point is 3 inches from the deck.

#### 5007. AT EASE FROM ANY POSITION OF THE SWORD

1. The command is "**AT EASE.**" It may be given from any position of the sword.

2. On "**AT EASE,**" go to order sword if not already at that position. Then move the left foot 12 inches to the left and lower the point of the sword to the deck. Rest the weight equally on both feet with the legs straight. At the same time, place the left hand behind you. Keep the fingers straight and joined, the palm flat and facing rear. You may relax and, except for your right foot and sword point, move about. Do not talk. (See figure 5-13.)



Figure 5-13.--At Ease.

5008. REST FROM ANY POSITION OF THE SWORD. The command is "**REST.**" It is executed in the same manner as at ease, the only difference being that you may talk.

5009. TO RETURN TO ATTENTION

1. The command is **"Platoon (Company or Detail), ATTENTION."** Execution is begun on the preparatory command.

a. On **"Platoon (Company or Detail)"** go to parade rest.

b. On **"ATTENTION,"** bring the left heel smartly against the right and the left hand to the side. Raise the blade so the point is 3 inches from the deck.

5010. RETURN SWORD FROM CARRY OR ORDER SWORD

1. The command is **"Return, SWORD."** Execution is begun on the preparatory command.

2. On the preparatory command **"Return."**

a. Officers raise the right hand and sword to a position 6 inches in front of the neck, as in the first count of present sword. At the same time, grasp the scabbard with the left hand just above the upper brass mounting ring. Tilt it forward and turn it clockwise 180 degrees. The scabbard should form a 45-degree angle with the deck. Then lower the sword point to a position just above the opening of the scabbard. Look down at the opening. Guide the point into the opening with the left thumb and forefinger until the right wrist and forearm is parallel to the deck. Then release the scabbard with the left hand and re-grasp it below the upper brass mounting ring. At the same time, raise the head back to attention. The left hand holds the scabbard against the side. (See figure 5-14.)



a. Raise Sword and Tilt Scabbard, Front View.



b. Raise Sword and Tilt Scabbard, Side View.



c. Insert Sword into Scabbard, Side View.

Figure 5-14.--Movements for Return Sword from Carry or Order Sword; Officers.



d. Final Position on Preparatory Command "Return," Front View.



e. Final Position on Preparatory Command "Return," Side View.

Figure 5-14.--Movements for Return Sword from Carry or Order Sword; Officers--Continued.

- b. Noncommissioned officers raise the right hand and sword to a position 6 inches in front of the neck as in the first count of present sword. At the same time, grip the scabbard just below the frog with the left hand. Tilt it forward to form an angle of 45 degrees with the deck. After a one count pause, lower the sword point to a position just above the opening of the scabbard while at the same time looking down to guide the point into the opening until about 10 inches of sword remain outside the scabbard and the right wrist and forearm are parallel to the deck. When this position has been obtained, raise the head back to attention. The left hand holds the scabbard against the side. (See figure 5-15.)

Enclosure (1)

5-20  
Ch 1





a. Raise Sword and Grasp Scabbard, Front View.



b. Raise Sword and Grasp Scabbard, Side View.

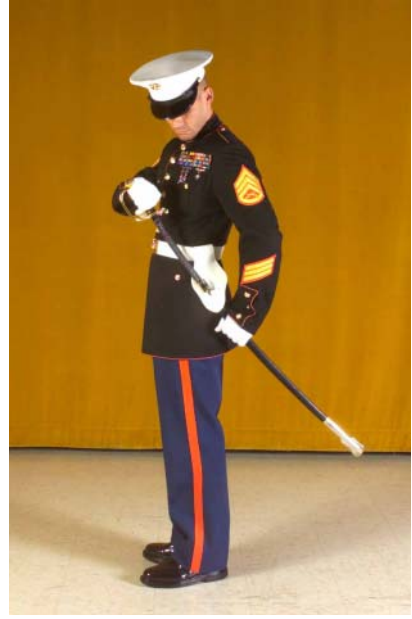

c. Insert Sword into Scabbard, Side View.



d. Final Position on Preparatory Command "Return," Front View.



e. Final Position on Preparatory Command "Return," Side View.

Figure 5-15.--Movements for Return Sword from Carry or Order Sword; Noncommissioned Officers.

c. On the command of execution "SWORD," push smartly down on sword and release the hand grip so it will slide all the way into the scabbard. Then bring the right hand smartly back to the right side. At the same time, release the scabbard with the left hand and assume the position of attention (officers must first turn the scabbard 180 degrees counterclockwise before releasing the scabbard with the left hand).

5011. FUNERAL CARRY

1. This position is assumed when marching for long distances such as when participating in funerals or street parades.
2. The movement to funeral carry may be executed at a pre-arranged point or on command. The command, if given, is "**FUNERAL CARRY.**" It is given without rise or inflection of the voice as either foot strikes the deck. This is not a precision movement, therefore, there are no counts. However, there are three steps in executing the movement.
3. At a designated point or on command while at the carry:
  - a. Reach across the body with the left hand and grasp the sword blade with the thumb and forefinger. The left forearm is parallel to the deck.
  - b. Change the grasp of the right hand so that the officer's sword grip is grasped between the index and middle fingers, with all fingers curled around the hilt. (See figure 5-16a.) The noncommissioned officer's sword knuckle bow is grasped between the index finger and the thumb; the remaining fingers are joined and curled. (See figure 5-16b.)
  - c. Release the grasp of the sword blade and return the left hand smartly to the side. Both arms will still swing in the same manner as they did at carry sword.
4. To return to carry sword, the command if given is "**CARRY SWORD.**" It will be given without rise or inflection of the voice. At a designated point or on command the above steps will be repeated. However, on step two, the grasp of the sword will change back to the carry sword position.



a. Officer.



b. Noncommissioned Officer.

Figure 5-16.--Funeral Carry.

5012. SWORD MOURNING KNOT

1. The mourning knot will be worn when officers and noncommissioned officers are detailed to military funerals when the sword is prescribed.
2. The mourning knot is a black ribbon of silk or other similar material, 3 inches wide and 27 inches long, each end finished with a small hem. The two flowing ends will be 12 inches long when the band is knotted upon the sword hilt.
3. On the officer's sword, the mourning knot is worn attached to the sword knot. It is formed by doubling the band, passing the free ends around and under the sword knot, immediately below the eye in the pommel, and then passing them back through the bight thus formed. The knot is then drawn taut. (See figure 5-17a.)
4. On the noncommissioned officer's sword, the knot is worn attached to the knuckle bow. It is formed by doubling the band, passing the free ends around the knuckle bow at the pommel, and then back through the bight thus formed and drawn taut. (See figure 5-17b.)



a. Officer.



b. Noncommissioned Officer.

Figure 5-17.--The Sword Mourning Knot.

5013. CARRY OF THE SWORD AND SCABBARD UNRIGGED

1. When not in formation and when it is impractical to carry the sword and scabbard rigged at the side (slung or in a frog), the sword sheathed in its scabbard may be carried under the left arm.

2. Place the sword and scabbard under the pit of the left arm with the hilt just to the rear of the left shoulder (knuckle bow up for noncommissioned officers, sword knot up for officers). The drag (noncommissioned officers) or shoe (officers) is to the front with the convex edge of the scabbard up. The left arm is crooked so that the left hand supports the scabbard forward of the shoulder. The left upper arm holds the scabbard against the body. The sword and scabbard slant downward from hilt to drag/shoe. (See figure 5-18.)



a. Officer.



b. Noncommissioned Officer.

Figure 5-18.--Unrigged Carry.

5014. MARCHING AT DOUBLE TIME WHEN ARMED WITH THE SWORD

1. While marching at double time, hold the sword diagonally across the chest with the true edge to the front. Hold the scabbard with the left hand just below the lower brass mounting ring or the frog. This is not a precision movement but should be executed as follows. (See figure 5-19.)

a. On the preparatory command "**Double Time,**" drop the sword diagonally across the chest with the blade bisecting the head and left shoulder and the true edge to the front. Grasp the scabbard below the lower mounting ring (officer) and below the frog (noncommissioned officer).

b. The movements should be complete prior to the command of execution "**MARCH.**"

2. Upon the command **"Quick Time, MARCH"** return to the position of carry sword and release the scabbard when taking the first 30-inch step.

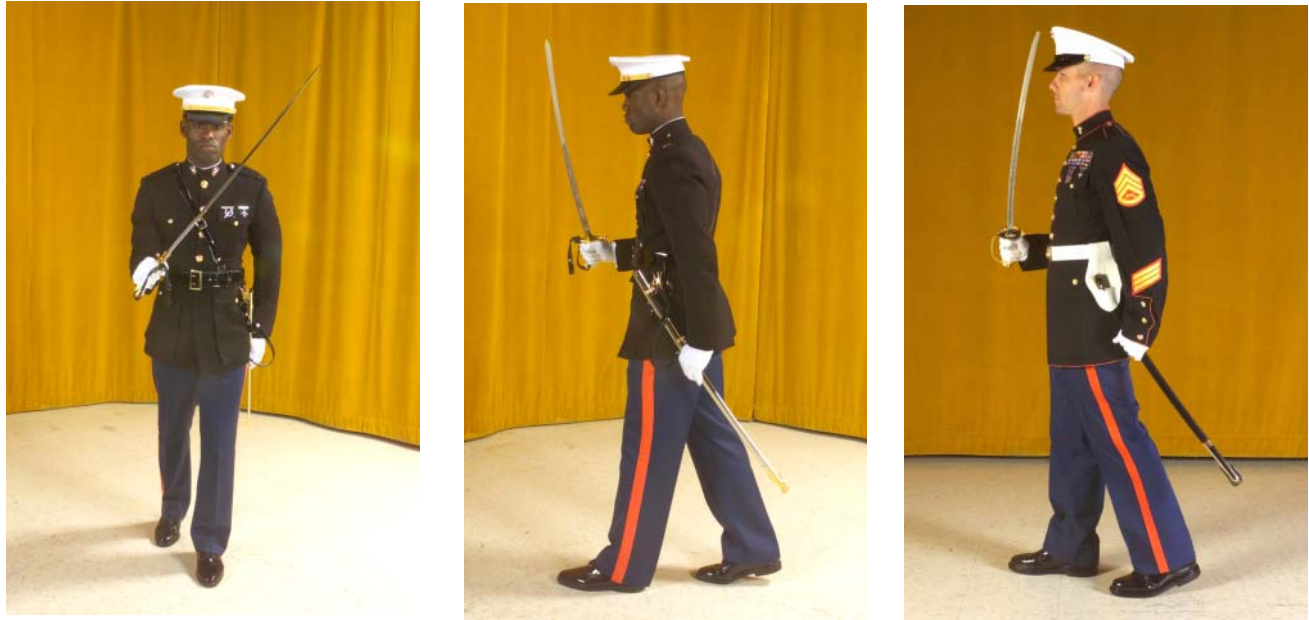

a. Front View, Officer.    b. Left Side View, Officer.    c. Left Side View, Non-commissioned Officer.

Figure 5-19.--Double Time Armed with a Sword.

5015. PUBLISH THE ORDER

1. When calling roll, reading documents, or publishing orders to a formation, slip the fingers of the left hand between the sword grip and sword knot (officers) or knuckle bow (noncommissioned officers). The sword hangs perpendicular to the deck and is held by the sword knot (officers) or knuckle bow (noncommissioned officers). The true edge is to the rear. Keep the left elbow against the side. Hold the document with both hands. (See figure 5-20.) This is not a precision movement but should be executed as follows.

a. Execute the movement from the position of order sword. Raise and move the sword diagonally across the front of the body until you can grasp the sword knot or knuckle bow with the left hand.

b. Upon completion of the reading reach across with the right hand, re-grasp the sword grip and return the sword to the position of order sword

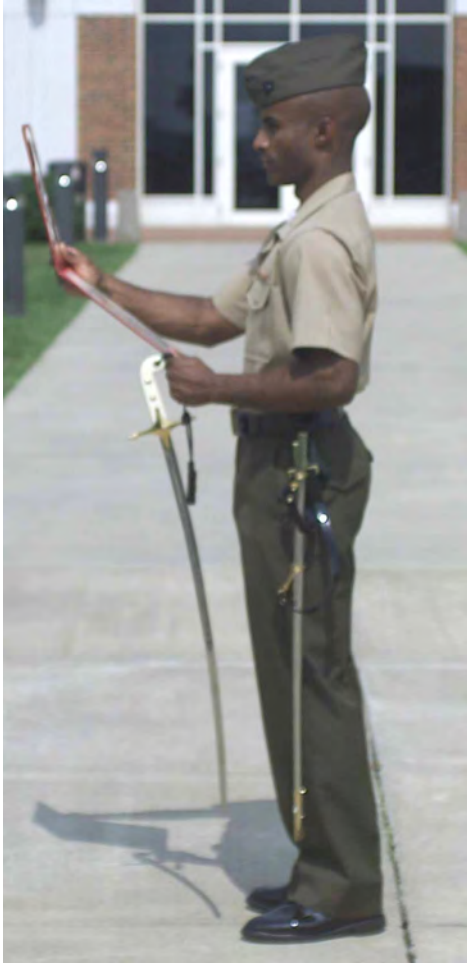

a. Officer.

b. Staff Noncommissioned Officer/  
Noncommissioned Officer.

Figure 5-20.--Publish the Order.

5016. FORMING AN ARCH OF SWORDS FOR WEDDINGS

- 1. The arch of swords for weddings is authorized for commissioned, warrant, staff noncommissioned, and noncommissioned officers. The arch of swords ceremony is an old English and American custom, which gives a symbolic pledge of loyalty to the newly married couple from their Marine family. Only the newly married couple is allowed to pass under the arch.
2. The ushers normally form the sword detail, however other officers, warrant or staff noncommissioned officers may be designated as needed. Customarily, six or eight members take part in the ceremony. The usher's form at the bottom of the chapel steps, in two equal ranks, at normal interval, facing each other, with sufficient room between ranks (3 to 4 paces) for the bride and groom to pass. The senior usher is positioned in the left rank furthest from the chapel exit. (See figure 5-21.)

Enclosure (1)

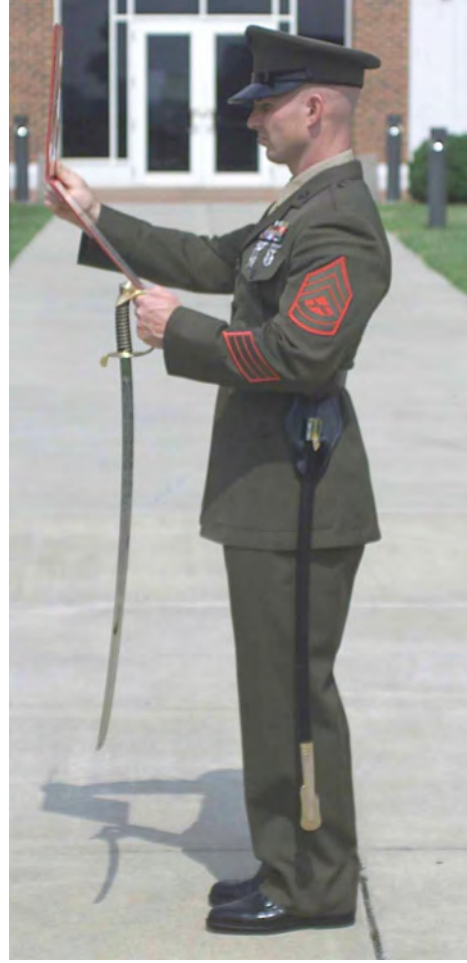
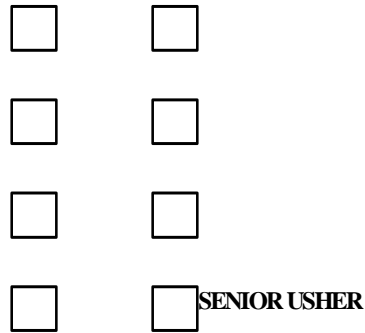
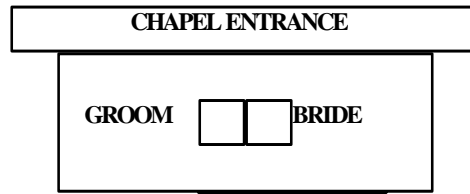

Figure 5-21.--Formation for the Arch of Swords.

3. After the guests have left the chapel to observe the ceremony, the bride and groom exit the chapel and stand just outside the main entrance. The senior usher will then form the arch of swords by giving the command of **"Draw, SWORD."**

a. On the preparatory command of **"Draw,"** execute the first count of the movement as described in paragraph 5001.

b. On the command of execution **"SWORD,"** the sword is removed from the scabbard in one continuous motion to an angle of 45 degrees, points touching across the aisle formed by the ushers. At this point halt and do not complete the final counts of draw sword.

4. The bride and groom, and only the bride and groom, then pass under the arch. As the newlyweds approach the last two ushers, (e.g., the two farthest from the chapel entrance) they slowly lower their swords to halt the couple. The senior usher then says "Welcome to the Marine Corps Family" or "Welcome aboard Mr./Mrs. \_\_\_\_\_ (rank of military member can be substituted for Mr./Mrs.), and then announce the new couple to those assembled." The last two ushers then slowly raise their sword back to the arch position and allow the couple to pass.

5. After the newlyweds have cleared the arch the senior usher gives the command of **"Return, SWORD."**

a. On the preparatory command of **"Return,"** move the sword to the present position and then to the scabbard as described in paragraph 5010.

b. On the command of execution **"SWORD,"** complete the movement of return sword as described in paragraph 5010.

6. The senior usher then dismisses the detail.

7. Though it is traditional that swords are never unsheathed in a chapel, the chaplain may grant permission to form the arch of swords indoors in the event of inclement weather. The ceremony would be performed at the rear of the chapel near or in the vestibule. The ceremony begins after the chaplain has concluded the wedding ceremony with the bride and groom passing under the arch of swords before the guests depart and is performed in the same manner as described above.

#### 5017. PASSING AN UNSHEATHED SWORD

1. At a Marine Corps Birthday cake cutting ceremony or a military wedding reception it is customary to use an officer or noncommissioned officer's sword to cut the birthday or wedding cake.

2. For a Marine Corps cake cutting ceremony the sword is usually placed unsheathed on the cake cart and handed to the commanding general/commanding officer by the senior escort. This is done by laying the sword over the left forearm, cutting edge away from the body, and the hilt towards the commanding general/commanding officer. (See figure 5-23.)

3. At a wedding an officer, warrant or staff noncommissioned officer passes his sword and presents it to his bride, by laying the sword over his left forearm, cutting edge away from the body, hilt towards the bride. (See figure 5-23.) The bride takes the sword and cuts the wedding cake, with the groom's right hand resting over hers on the sword's hilt and with his left arm free to place around his bride. (NOTE: To preclude damaging the sword's blade, ensure it is thoroughly cleaned prior to returning it to the scabbard.)



Figure 5-23.--Passing an Unsheathed Sword.



MARINE CORPS DRILL AND CEREMONIES MANUAL

PART I: DRILL

CHAPTER 6

GUIDON MANUAL

	<u>PARAGRAPH</u>	<u>PAGE</u>
GENERAL . . . . .	6000	6-3
ORDER GUIDON . . . . .	6001	6-4
CARRY GUIDON . . . . .	6002	6-5
DOUBLE TIME WITH THE GUIDON . . . . .	6003	6-5
CARRY GUIDON FROM ORDER GUIDON . . . . .	6004	6-6
ORDER GUIDON FROM CARRY GUIDON . . . . .	6005	6-6
PRESENT GUIDON FROM ORDER OR CARRY GUIDON . . . . .	6006	6-6
ORDER GUIDON AND CARRY GUIDON FROM PRESENT GUIDON . . . . .	6007	6-8
PRESENT GUIDON FROM CARRY GUIDON AT OFFICERS CENTER . . . . .	6008	6-8
CARRY GUIDON FROM PRESENT GUIDON AT OFFICERS CENTER . . . . .	6009	6-8
READY GUIDON FROM ORDER OR CARRY GUIDON . . . . .	6010	6-9
GUIDON SALUTE FROM CARRY OR ORDER GUIDON . . . . .	6011	6-10
RESTS WITH THE GUIDON . . . . .	6012	6-10

FIGURE

6-1 GUIDON AND STAFF . . . . .	6-3
6-2 ORDER GUIDON . . . . .	6-4
6-3 CARRY GUIDON . . . . .	6-5
6-4 GUIDON CARRY AT THE DOUBLE TIME . . . . .	6-6
6-5 PRESENT GUIDON . . . . .	6-7
6-6 EYES RIGHT WITH THE GUIDON . . . . .	6-7
6-7 MOVEMENTS TO CARRY GUIDON FROM PRESENT GUIDON . . . . .	6-8
6-8 READY GUIDON . . . . .	6-9
6-9 GUIDON SALUTE FROM CARRY OR ORDER GUIDON. . . . .	6-10
6-10 PARADE REST WITH THE GUIDON . . . . .	6-11



PART I: DRILL

CHAPTER 6

GUIDON MANUAL

6000. GENERAL

1. The guidon is a company or battery identification flag. It is carried on an 8-foot staff at ceremonies and at other times prescribed by the commander. (See figure 6-1.) MCO P10520.3 provides detailed specifications for unit guidons.

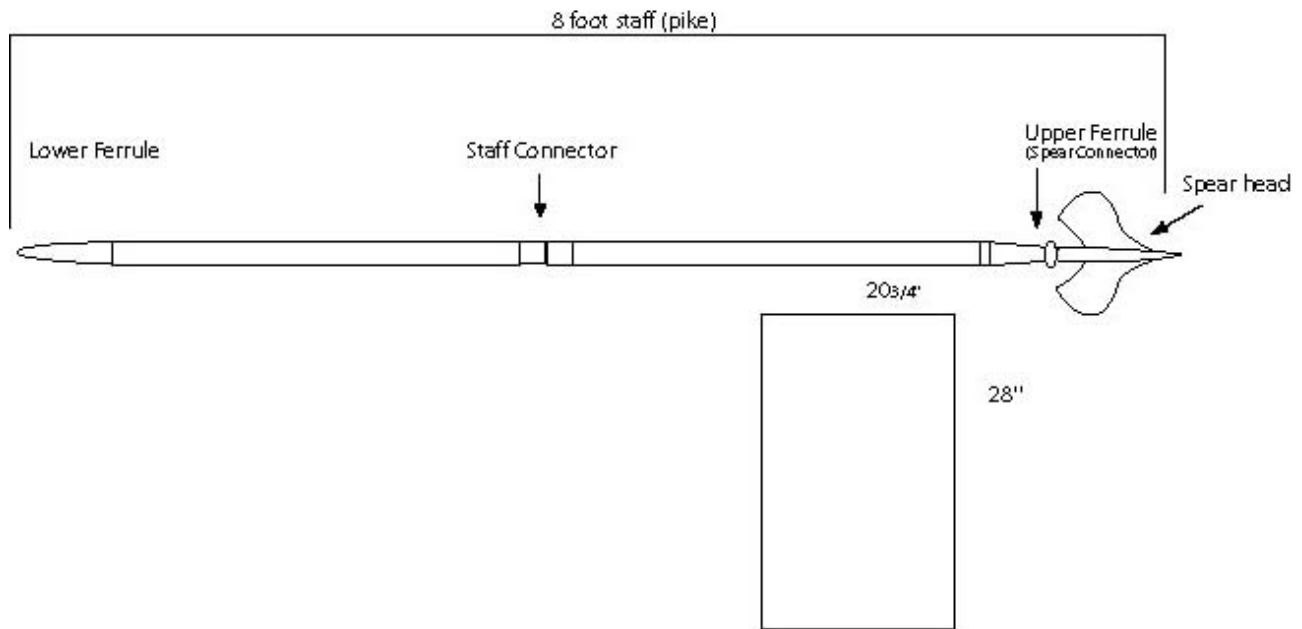

Figure 6-1.--Guidon and Staff.

2. In garrison, the guidon may be displayed at company headquarters between morning and evening colors, except during inclement weather and when carried in formation.
3. In selecting a guidon bearer, the company commander should choose an individual who is outstanding in bearing, appearance, and ability.
4. When acting as guidon bearer, the individual is considered under arms and does not have to carry a weapon. If a weapon is carried, it will be slung or holstered.
5. The guidon is brought to present guidon, parade rest, and order guidon with the company.
6. When at route step or at ease march, the guidon may be carried in either hand. When at order guidon, bring the guidon to carry on the preparatory command for marching in quick time.

7. When at order guidon, the guidon is brought to carry on the preparatory command for any facing or marching movement.

8. The guidon staff should be marked with two thumbtacks. The first tack marks the position of the guidon bearer's right thumb position at order guidon. The second thumbtack is placed 6 inches above the first tack to mark the guidon bearer's right thumb position at carry guidon.

9. The two grasps of the guidon are identified as the "V" grip and the strong grip. The staff is placed in the "V" formed by the thumb and fingers of the right hand. Thumb along the trouser seam with the fingers extended and joined. The strong grip is when the thumb is wrapped around the front of the staff with the fingers wrapped to the rear. (See figure 1-4.)

a. The "V" grip is used at the order and when executing "Present Guidon" and during "Eyes Right/Left" and "Officers Center."

b. The strong grip is used while on the march and facing movements.

6001. ORDER GUIDON. At order guidon, the ferrule rests on the deck touching the outside edge of the right shoe close to the little toe. The staff is grasped in the "V" grip with the right elbow close to the side so that the forearm helps to support the staff. The upper staff rests in the hollow of the right shoulder. The staff is vertical with the flat side of the spearhead facing front. The rest of the body is at attention. (See figure 6-2.)



Figure 6-2.--Order Guidon.

6002. CARRY GUIDON. This is the normal position of the guidon while marching at quick time. It is carried using the strong grip with the ferrule 6 inches above the deck and the flat side of the spearhead facing front. (See figure 6-3.)



Figure 6-3.--Carry Guidon.

6003. DOUBLE TIME WITH THE GUIDON. For marching at double time, on the preparatory command, bring the staff across the body with the spearhead to the left. The right hand grasps the same spot as at carry. The right forearm is level with the deck and the elbow against the body. Grip the staff with the left hand in front of the point where the neck and left shoulder join. The flat side of the spearhead should face front. (See figure 6-4.)

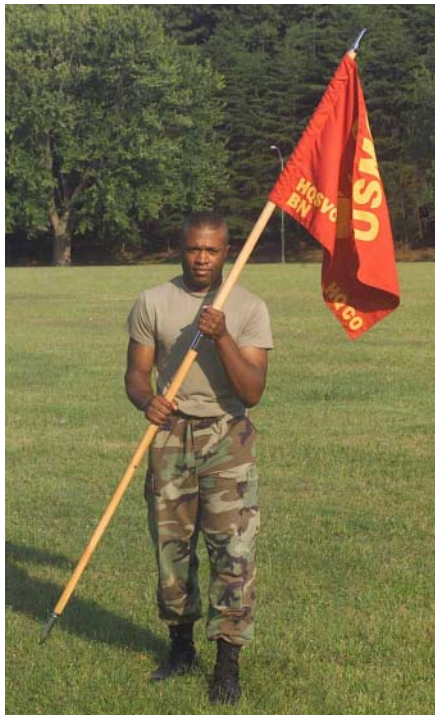

Figure 6-4.--Guidon Carry at the Double Time

6004. CARRY GUIDON FROM ORDER GUIDON. This movement is executed on the preparatory command for any movement that will require the guidon bearer's feet to be moved. Execution is begun on a preparatory command such as "Forward," "About," etc.

1. On the preparatory command, reach across the body and grasp the staff with the left hand 2 inches above the right.
2. Change the grasp to the strong grip, while raising the staff with the left hand until the ferrule is 6 inches above the deck. Hold the staff vertical with the right hand.
3. Move the left hand smartly back to the side.

6005. ORDER GUIDON FROM CARRY GUIDON. This movement is executed without command at the completion of any movement that required the guidon bearer to come to carry guidon. If there are a series of movements, executed immediately one after the other, order guidon will not be executed until after the final one. Order guidon is executed in one count by allowing the staff to slip through the right hand until the lower ferrule rests on the deck, and change the grasp to the "V" grip.

6006. PRESENT GUIDON FROM ORDER OR CARRY GUIDON. From order or carry guidon, this movement is executed on command. During officers center, the movement is executed after halting, from the carry and without command. Since the right hand is 6 inches lower on the staff at carry than at order, the ferrule will extend farther to the rear when at present guidon from order than it will at present guidon from the carry.

1. From order guidon, the command is **"Present, ARMS."** It is executed in one count.
2. On **"ARMS,"** lower the guidon straight to the front. The right arm is extended until the lower portion of the staff rests in the pit of the right arm and the entire staff is horizontal to the deck. As the staff is lowered rotate the staff to the right so that the sharp edge of the spearhead faces down. Hold the right elbow firmly against the body. (See figure 6-5.)



Figure 6-5.--Present Guidon.

3. From carry guidon the command is **"Eyes, RIGHT (LEFT)."** It is executed in the same manner as from order guidon except that the head and eyes are turned right (left) 45 degrees as the guidon is lowered. (See figure 6-6.)



Figure 6-6.--Eyes Right with the Guidon.

6007. ORDER GUIDON AND CARRY GUIDON FROM PRESENT GUIDON

1. To return to order guidon, the command is **"Order, ARMS."**
2. On the preparatory command **"Order,"** grasp the staff smartly and audibly with the left hand, palm up, at a point just forward of the right hand. (See figure 6-7.) On **"ARMS,"** with the left hand, pull the guidon staff up and back to the vertical position of carry guidon, pivoting it on the right hand as it is lowered back to the right side. Then let the staff slide straight downward through the right hand until the lower ferrule rests on the deck, the left hand steadies the staff as it slides downward. Cut the left hand smartly back to its normal position at the left side. The flat side of the spearhead is back facing to the front.



Figure 6-7.--Movements to Carry Guidon from Present Guidon.

3. To return to carry guidon the command is **"Ready, FRONT."**
4. On the preparatory command **"Ready,"** grasp the staff smartly and audibly with the left hand, palm up, at a point just forward of the right hand. On **"FRONT,"** with the left hand, pull the guidon staff up and back to the vertical position of carry guidon, pivoting it on the right hand as it is lowered back to the right side. The flat side of the spearhead facing to the front. Cut the left hand back to the left side and turn the head and eyes smartly to the front.

6008. PRESENT GUIDON FROM CARRY GUIDON AT OFFICERS CENTER. This movement is executed without command, upon halting at officers center during a parade. It is executed in one count as explained in paragraph 6006.2. The movement will be executed on the fourth count after the command **"Officers, HALT."** For details on executing officers halt refer to paragraphs 17006.9 through 17006.14.

6009. CARRY GUIDON FROM PRESENT GUIDON AT OFFICERS CENTER

1. The command is **"Carry, SWORD."** **"Ready, TWO"** if the officers are not armed with swords.



2. On the preparatory command "**Carry (Ready),**" grasp the staff with the left hand and on the command of execution "**WORDS (TWO)**" bring the staff back to the carry guidon position as described in paragraph 6002.

6010. READY GUIDON FROM ORDER OR CARRY GUIDON. This movement is used as a signal for aiding troops in the execution of commands where hearing verbal commands is difficult. When directed by the unit commander, the guidon is brought to ready guidon on specified preparatory commands. Ready guidon may be used as a signal for the execution of any command except present arms and eyes right (left), at which times the guidon must render honors.

1. On the specified preparatory command, bring the left hand across the body to grasp the staff above right hand. Change the grasp of the right hand so that the staff is gripped from the rear. Then raise the right hand to shoulder height, causing the guidon to be raised approximately 3 feet. At the same time, change the grasp of the left hand from above the right hand to just above the lower ferrule. This is the position of ready guidon. (See figure 6-8.)

2. On the command of execution, smartly lower the right hand and staff to the position of carry guidon. At the same time, return the left hand to a position above the right hand and steady the staff as the grasp of the right hand is changed. Return the left hand to the position of attention.

3. Ready guidon may also be executed without command during formation of a unit prior to march on for a review of parade. The guide executes it after the unit has been brought to attention (right shoulder arms if so armed) after the adjutant has commanded, "**Sound, ATTENTION.**" Ready guidon is used to signal the adjutant that the unit is ready for his next command.



Figure 6-8.--Ready Guidon.

6011. GUIDON SALUTE FROM CARRY OR ORDER GUIDON

1. The command is "**Guidon (Rifle), SALUTE.**" This movement may be executed on command, when in formation, or individually if the guidon bearer is in route to or from a formation. It is executed in two counts

- 2. On "**SALUTE,**" move the left hand, palm down, smartly to a position above the right hand with the left arm parallel to the deck. Keep the thumb and fingers straight and together. Touch the staff with the first joint of the forefinger. Turn the head and eyes toward the person being saluted. (See figure 6-9.)



Figure 6-9.--Guidon Salute

from Carry or Order Guidon.

3. After the salute is "**Order (Ready), ARMS (TWO)**" smartly back to the left side and look to the front.

returned, or the command is given move the left hand

6012. RESTS WITH THE GUIDON1. Parade Rest from Order Guidon

a. The command is "**Parade, REST.**" It is executed in one count. It may be given only when halted at attention.

Enclosure (1)

b. On the command of execution "**REST,**" slide the right hand up the staff to shoulder height. The staff remains in place and vertical. Without loss of motion, straighten the right arm so the staff of the guidon tilts forward at 30 degrees. The fingers and thumb of the right hand are wrapped around the staff. The ferrule remains in the same position as at order guidon. The flat side of the spearhead remains facing front. Place the left hand behind the back, just below the belt. Keep the fingers straight and touching. The palm is flat and facing the rear. At the same time, move the left foot smartly 12 inches to the left of the right foot. (See figure 6- 10b.)



a. Front.



b. Side.

Figure 6-10.--Parade Rest with the Guidon.

## 2. At Ease from Any Position of the Guidon

a. The command is "**AT EASE.**" It is executed in two counts. It may be given only when halted at attention.

b. On the command, and for count one, execute parade rest as described in paragraph 6012.1b.

c. On the second count, you may relax and, except for your right foot and ferrule, move about. Do not talk.

3. Rest from Any Position of the Guidon. The command is "**REST.**" It is executed in the same manner as at ease the only exceptions being that you may talk and hold the staff in either hand.

4. Fall Out from Order Guidon. The command is "**FALL OUT.**" It may be given only from order guidon. Upon the command, leave your position in ranks but remain nearby.

5. Order Guidon from Rest Positions

a. From parade rest, at ease, and rest, the command is "**Platoon (Company or Battalion), ATTENTION.**" On the preparatory command, go to parade rest, if not already in that position. At the command "**ATTENTION,**" go smartly to order guidon.

b. From fall out, the command is "**FALL IN.**" Upon the command, go back to your position in formation and stand at attention at order guidon.

MARINE CORPS DRILL AND CEREMONIES MANUAL

PART I: DRILL

CHAPTER 7

NATIONAL AND ORGANIZATIONAL FLAGS

	<u>PARAGRAPH</u>	<u>PAGE</u>
GENERAL . . . . .	7000	7-5
COLOR SALUTES . . . . .	7001	7-7
HOISTING, LOWERING, AND FOLDING THE NATIONAL ENSIGN . . . . .	7002	7-7
SALUTES AND HONORS TO THE NATIONAL FLAG . . . . .	7003	7-12
COMPOSITION OF THE COLOR GUARD . . . . .	7004	7-13
SYNCHRONIZING THE MANUAL OF ARMS FOR THE COLOR GUARDS ARMED WITH RIFLES . . . . .	7005	7-18

SECTION 1: MANUAL OF THE COLORS

ORDER COLORS . . . . .	7100	7-25
CARRY COLORS FROM ORDER COLORS . . . . .	7101	7-26
ORDER COLORS FROM CARRY COLORS . . . . .	7102	7-28
PRESENT COLORS FROM ORDER COLORS . . . . .	7103	7-31
SALUTES BY THE ORGANIZATIONAL COLORS . . . . .	7104	7-32
ORDER COLORS FROM PRESENT COLORS . . . . .	7105	7-33
PRESENT COLORS FROM CARRY COLORS . . . . .	7106	7-33
CARRY COLORS FROM PRESENT COLORS . . . . .	7107	7-33
RESTS WITH THE COLORS . . . . .	7108	7-33
EYES RIGHT (LEFT) FROM CARRY OR ORDER COLORS . . . . .	7109	7-35
CARRY OR ORDER COLORS FROM EYES RIGHT (LEFT) . . . . .	7110	7-36
TRAIL ARMS WITH THE COLORS . . . . .	7111	7-37

SECTION 2: MOVEMENTS OF THE COLOR GUARD

FACE THE COLOR GUARD TO THE RIGHT (LEFT). . . . .	7200	7-39
FACE THE COLOR GUARD TO THE REAR . . . . .	7201	7-40

MARINE CORPS DRILL AND CEREMONIES MANUAL

	<u>PARAGRAPH</u>	<u>PAGE</u>
MOVEMENTS UTILIZED BY JOINT COLOR GUARDS (JCG) . . . . .	7202	7-41
RIGHT (LEFT) WHEEL . . . . .	7203	7-41
LEFT ABOUT . . . . .	7204	7-42

SECTION 3: COLOR GUARD PROTOCOL

GENERAL . . . . .	7300	7-43
RECEIVING THE COLORS BY THE COLOR GUARD . . . . .	7301	7-43
RECEIVING THE COLORS BY THE COLOR COMPANY (BATTALION) . . . . .	7302	7-44
DISMISSING THE COLOR GUARD . . . . .	7303	7-45
RETURNING THE COLORS BY THE COLOR GUARD . . . . .	7304	7-45
CASING AND UNCASING THE COLORS . . . . .	7305	7-45
TROOPING THE COLORS . . . . .	7306	7-47
INDOOR CEREMONIES INVOLVING COLOR GUARDS . . . . .	7307	7-48
ORDERING COLORS, STAFFS AND OTHER CEREMONIAL GARRISON PROPERTY	7308	7-52

FIGURE

7-1	DIFFERENT TYPES AND NOMENCLATURE OF ENSIGNS . . . . .	7-8
7-2	POSITION OF NATIONAL ENSIGN AT HALF-MAST . . . . .	7-9
7-3	FOLDING THE ENSIGN . . . . .	7-11
7-4	COLOR GUARD COMPOSITION . . . . .	7-14
7-5	THE COLOR STAFF . . . . .	7-17
7-6	CARRY COLORS TO ORDER COLORS . . . . .	7-18
7-7	CARRY COLORS TO PRESENT COLOR . . . . .	7-20
7-8	PRESENT COLORS TO CARRY COLORS . . . . .	7-22
7-9	ORDER COLORS . . . . .	7-25
7-10	CARRY COLORS FROM ORDER COLORS . . . . .	7-26
7-11	ORDER COLORS FROM CARRY COLORS . . . . .	7-28

MARINE CORPS DRILL AND CEREMONIES MANUAL

	<u>PAGE</u>
7-12	PRESENT COLORS FROM ORDER COLORS . . . . . 7-31
7-13	SALUTES BY THE ORGANIZATIONAL COLORS . . . . . 7-32
7-14	COLOR GUARD AT PARADE REST . . . . . 7-34
7-15a	EYES RIGHT, HALTED . . . . . 7-35
7-15b	EYES RIGHT, MARCHING . . . . . 7-36
7-16	MARCHING AT TRAIL COLORS . . . . . 7-37
7-17	RIGHT (LEFT) TURN . . . . . 7-39
7-18	COUNTERMARCH . . . . . 7-40
7-19	RIGHT (LEFT) WHEEL ABOUT . . . . . 7-41
7-20	LEFT ABOUT . . . . . 7-42
7-21	RECEIVING/RETURNING THE COLORS BY THE COLOR GUARD . . . 7-43
7-22	RECEIVING/RETURNING THE COLORS BY THE COLOR COMPANY . . 7-44
7-23	UNCASING AND CASING COLORS . . . . . 7-46
7-24	TROOPING THE COLORS . . . . . 7-48
7-25	POSTING AND RETRIEVING THE COLORS INDOORS . . . . . 7-49
7-26	MARCH IN COLUMN OF TWOS AND REFORM . . . . . 7-50
7-27	MARCH IN COLUMN OF ONES AND REFORM . . . . . 7-50
7-28	POSTING AND RETRIEVING THE COLORS INDOORS (FLAG STANDS SEPARATED) . . . . . 7-51





MARINE CORPS DRILL AND CEREMONIES MANUAL

SECTION I: DRILL

CHAPTER 7

NATIONAL AND ORGANIZATIONAL FLAGS

7000. GENERAL

1. When flown from ships or crafts of the Navy or from a flagstaff at commands ashore, the national flag will be displayed per the provisions of *U.S. Navy Regulations*. The national flag is also called the "national ensign" or "ensign."

2. Marine organizations are equipped with a national flag and an organizational flag. The organizational flag is an official flag that is authorized to be displayed by an organization of the U.S. Marine Corps.

3. When mounted on a staff (pike) and carried by an individual on foot, or displayed or cased in a fixed location, the national flag is called the "national colors" and the organizational flag is called the "organizational colors." The term "colors" means either or both the national colors and the organizational colors.

→ a. The use of the plural form of the word color (colors) to designate a single flag, ensign, standard, or pennant comes from the ancient tradition of referring to the multiple colors found on these types of standards. This tradition is carried on today when we refer to the national colors; red, white, and blue and the Marine Corps colors; scarlet and gold. The plural form is also used when referring to the types of movements, ceremonies or musical accompaniment involving the colors, i.e., carry colors, morning colors, "To the Color" etc.

b. When designating personnel or units as part of color details then the appropriate singular or plural form of the word will be used, i.e., color guard, color company, etc.

4. When mounted on a vehicle, the national flag is called the "national standard" and the organizational flag is called the "organizational standard." The term "standard" means the national standard only. The term "standards" means both the national standard and the organizational standard.

5. In garrison or on board ship, the colors of an organization, when not in use, are kept by the commanding officer. Whenever practicable, colors should be kept uncased and displayed in the office of the commanding officer, or other appropriate place. They may be cased, however, by placing them within a protective covering. Colors that are kept cased and not used often should be unfurled and aired frequently.

6. The colors (standards) may be carried in any formation in which two or more companies participate, and in escorts and honor guards when ordered. Separate companies and detachments, who are authorized organizational colors, may carry colors when two or more platoons participate. Unless otherwise directed for special ceremonies, the national colors will always be carried when the organizational colors are carried, but the national colors may be carried alone.

7. In battalion formations, the colors (standards) will be posted with a designated color company and in regimental formations with a designated color battalion. The color company (battalion) is posted in the formation so that the color guard is in the approximate center of the formation (right or forward of center if this is impossible).
8. In most regimental formations, only the colors (standards) of the regiment will be carried. When two or more separate battalions are formed as a regiment, only the colors (standards) of one battalion will be carried for the regiment. When authorized by the commander, however, the organizational colors of subordinate organizations may be carried in ranks (massed color guard) arranged behind the parent organization's color guard.
9. When the organizational colors are draped in mourning, the mourning streamer shall consist of a black crepe streamer 7 feet long and about 12 inches wide. A bowknot, the loops of which are 6 inches long, is tied in the center. This knot attaches the streamer to the upper ferrule, just below the spearhead. If a streamer attachment set is used, the bowknot will be tied on the upper ferrule below the streamer attachment set in a manner so as not to disturb the natural hang of the unit's battle streamers.
10. Uncased colors will be treated with dignity and formality. When moved while outdoors, they will be marched by a color guard. Whenever possible, they will be escorted by a color company (battalion) from the organizational headquarters to the place of the ceremony. If it becomes necessary to case or uncase the colors outdoors, it will be accomplished with proper ceremony as described in paragraph 7305.
- 11. Whenever the colors are brought forward of the line of troops (e.g., trooping the colors, for retirements, awards, etc.) the command must present arms. If a band or bugler is present and the colors are uncased, the appropriate music, e.g., "*National Anthem*," "*To the Color*," or "*Retreat*" will also be played
12. During training and rehearsals (except full dress rehearsals), colors will be cased.
13. Colors (standards) are never allowed to touch the deck.
14. Color guards do not fix bayonets.
15. The standard weapon used for the color guard is the M16A2 service rifle.
16. Those units, whose T/O ceremonial weapons are the M1 or M14 rifle, should refer to appendixes A and B for the manual of arms.
17. The use of gold fringe on the U.S. Flag is expressly forbidden for Marine Corps organizations.
18. The U.S. Flag, when displayed or carried on a staff (pike) is adorned with a red, white, and blue rope and tassel. The organizational color is adorned with a scarlet and gold rope and tassel. However, once a unit has been awarded a streamer the rope and tassel is removed from the organizational color and a streamer attachment set added between the upper ferrule and the spearhead. Ropes and tassels are affixed to the top of the staff between the two ribs of the upper ferrule using a girth hitch knot. (See figure 7-5.)

Enclosure (1)

19. The national and organizational colors are only destroyed when; they have become soiled beyond cleaning, torn beyond repair and to keep them from falling into enemy hands.
20. Flags that may have a historical significance are disposed of per the instructions contained in MCO P10520.3.
21. National and organizational colors will only be carried on wooden 9 1/2-foot flagstuffs. The use of metal flagstuffs is only authorized for Marine Barracks Washington, DC.
22. For further information concerning flags, streamers and guidons refer to MCO P10520.3.

#### 7001. COLOR SALUTES

1. **By the National Colors (Standard).** The national colors (standard) renders no salute, except as specified in *U.S. Navy Regulations*, paragraph 1263.1.
- 2. **By the Organizational Colors.** In military ceremonies, the organizational colors salutes while the "*National Anthem*," "*To the Color*," "*Retreat*," or "*Hail to the Chief*" is being played, and when rendering honors to the organizational commander, individual of higher rank, or the dead, but in no other case. (See par. 7104.)
3. **By the Organizational Standard.** The organizational standard renders no salutes as it is mounted on a vehicle.

#### 7002. HOISTING, LOWERING, AND FOLDING THE NATIONAL ENSIGN

##### 1. General

- a. The ceremonial hoisting and lowering of the national ensign at 0800 and sunset, respectively, shall be accomplished ashore per the provisions of *U.S. Navy Regulations* and this paragraph.
- b. A detail consisting of a noncommissioned officer and two enlisted members of the guard will hoist and lower the ensign. This detail will be armed with sidearms, if the special equipment of the guard includes sidearms; otherwise, the pistol belt only will be worn.
- c. The commander of the guard ashore will see that the proper ensign is flown at the appropriate time and under all weather conditions. For different types of ensigns. (See figure 7-1.) Any member of the guard who observes any hazard to the ensign, such as loosened halyards, fouling, etc., will immediately report them to the commander of the guard.

2. **Positions of the Ensign.** The ensign is flown from the peak or truck of the mast, except when directed to be flown at half-mast. The ensign at half-mast is flown, when possible, with the middle point of its hoist opposite the middle point of the mast. The middle point of a guyed mast is midway between the peak of the mast and the point of attachment of the guys. The middle point of a mast with a yardarm is midway between the peak of the mast and the yardarm. Technically, an ensign at any position other than at the peak of the mast is half-mast. Local conditions may require other positions. To half-mast the ensign, it is first hoisted to the peak and then lowered to the half-mast position.

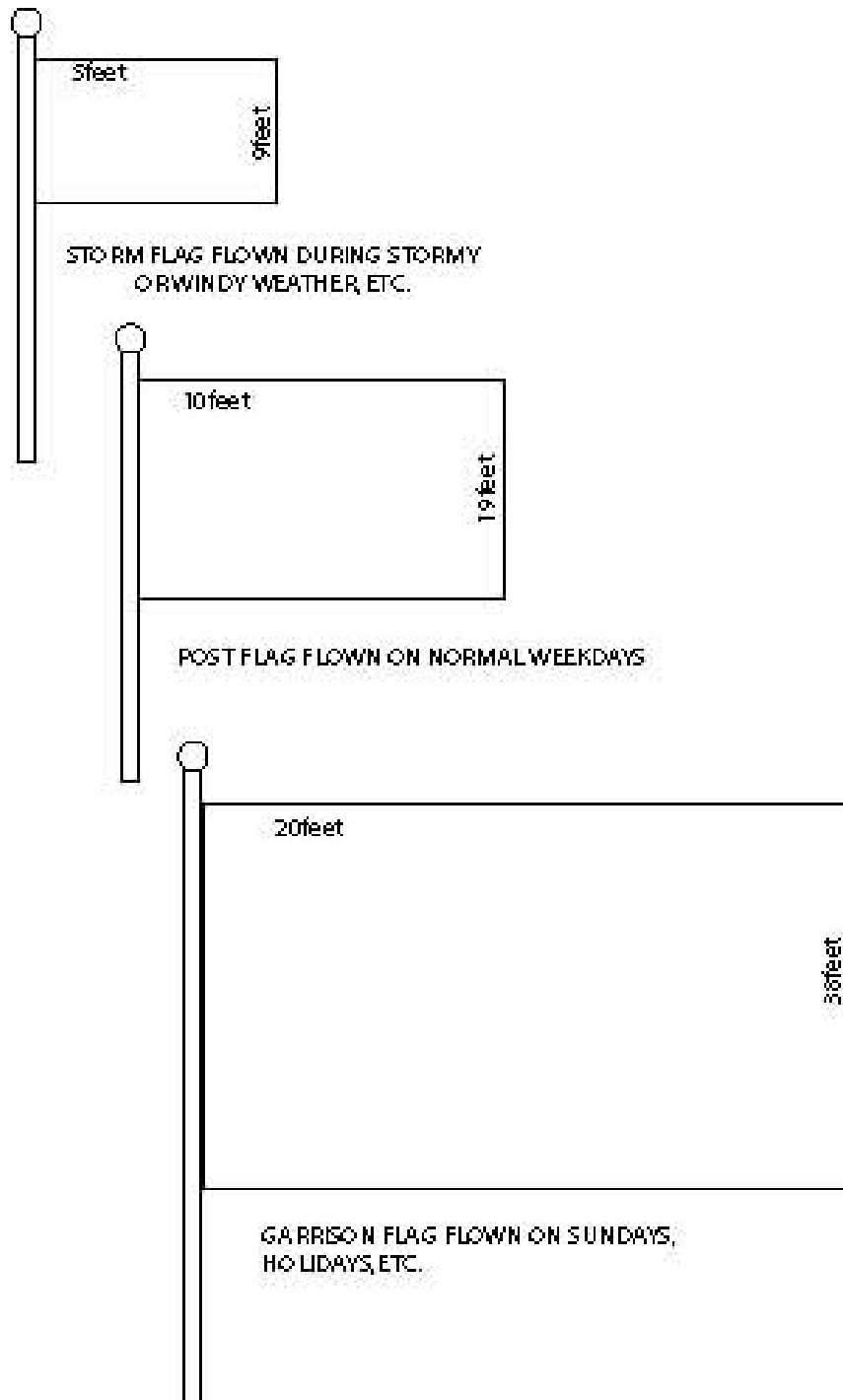

Figure 7-1.--Different Types and Nomenclature of Ensigns.

- 3. Hoisting the Ensign. The detail assigned to hoist the ensign is formed in line at the guardhouse with the noncommissioned officer carrying the folded ensign in the center. The detail is then marched to the flagstaff, halted, and the ensign attached to the halyards. The halyards are manned by the two enlisted members, who take positions on opposite sides of the staff, facing it, so they will be able to hoist the ensign without fouling it. The flag should be clearly marked so that the blue field is raised first. Additionally, the ensign should be pulled sufficiently, prior to the beginning of colors, to insure the blue field is hoisted first. This action precludes the embarrassment of hoisting the ensign upside down. The noncommissioned officer continues to hold the ensign until it is hoisted clear of his grasp to prevent it from touching the deck. When the ensign is clear, the noncommissioned officer executes a hand salute. After the ensign is hoisted, the other members of the detail grasp the halyard in their left hand and execute a hand salute. On the last note of the "*National Anthem*" or "*To the Color,*" all members of the detail terminate their hand salutes. If the ensign is to be flown at half-mast, it is then lowered slowly to that position. (See figure 7-2.) The halyards are then secured to the cleat of the mast. The detail is again formed, marched to the guardhouse, and dismissed.

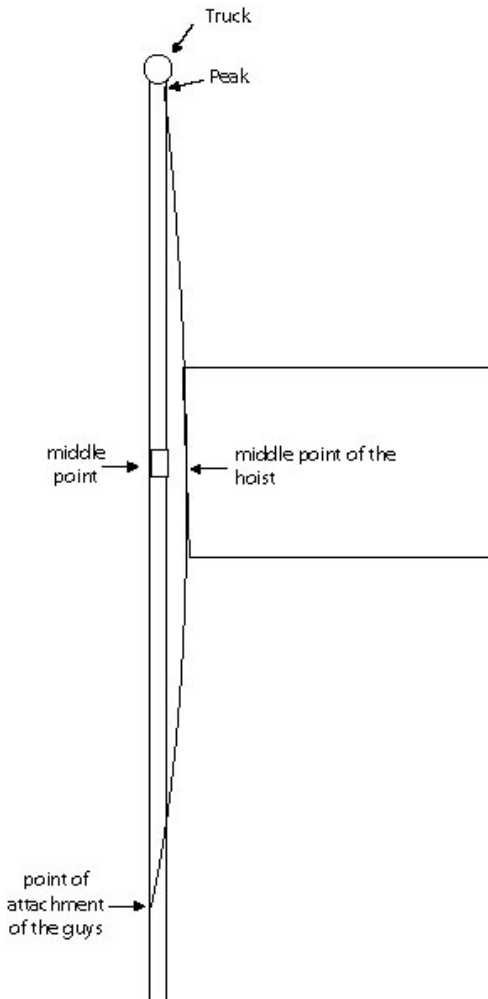

Figure 7-2.--Position of Mast.

National Ensign at Half-

4. Lowering the Ensign. The detail is formed at the guardhouse, marched to the flagstaff, and the halyards manned in the same manner as for hoisting the ensign. On the first note of the "*National Anthem*" or "*Retreat*," the ensign is slowly lowered. If at half-mast, it is first hoisted smartly to the peak on the first note of the music, and then slowly lowered. The noncommissioned officer catches it at the last note of the music. The ensign is detached from the halyards and folded as prescribed below. The halyards are secured to the mast; the detail is formed and marched to the guardhouse, where the ensign is turned over to the commander of the guard.

5. Replacing an Ensign Already Hoisted. There may be times when it is necessary to replace the ensign after morning colors but prior to evening colors. Some examples are, changing to a storm flag due to inclement weather; the ensign becomes fouled in the halyards; the ensign is raised upside down; etc.

a. If the flagstaff is double rigged, i.e., has two sets of halyards, the new ensign is hoisted to the peak or truck and then the ensign being replaced is slowly lowered, folded and returned to the guardhouse.

b. If the flagstaff has only one halyard, two color details are used to replace the ensign. The first color detail slowly lowers the ensign, and then quickly moves from the flagstaff to fold the old ensign. The second color detail, with the replacement ensign, then moves to the flagstaff and hoists the new ensign to the peak or truck. Both details salute as the replacement ensign is hoisted. Both color details then return to the guardhouse.

6. Folding the Ensign. The ensign is folded in half the long way so the crease parallels the red and white stripes. It is folded in half again so the new crease also parallels the red and white stripes with the blue field on the outside of the fold. The lower corner of the fly end (away from the blue field) is folded up to the top so the single (folded) edge lays perpendicular across the stripes. By repeatedly folding along the inboard edge of the triangle, the ensign is folded into the shape of a cocked hat. (See figure 7-3.)

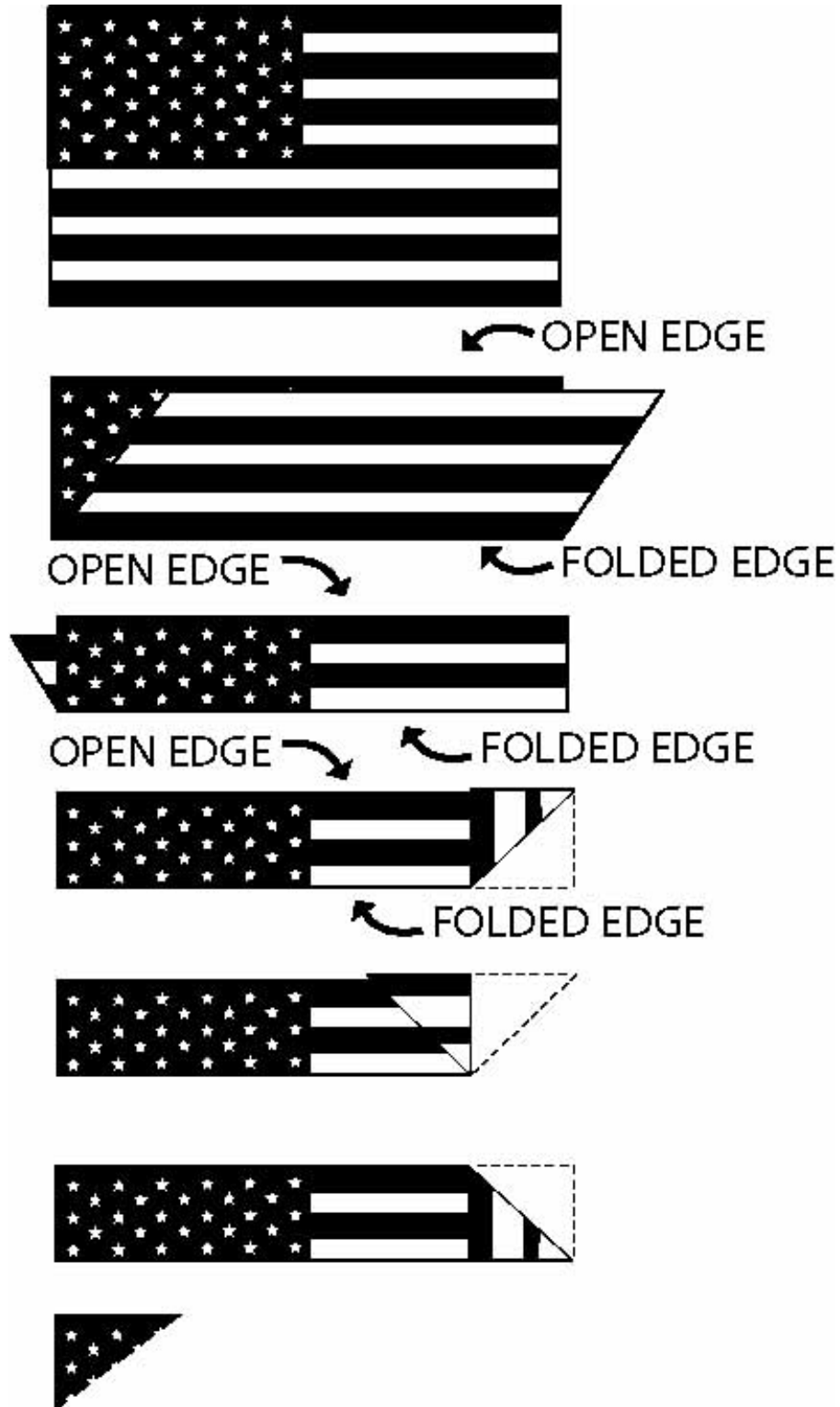

Figure 7-3.--Folding the Ensign.

7003. SALUTES AND HONORS TO THE NATIONAL FLAG

1. General. Salutes to the national flag are rendered per *U.S. Navy Regulations*. (See chapter 12, section 2.)

- 2. By Individuals. Individuals in the Navy, when in uniform and covered will render the appropriate salute (hand, rifle, etc.) as indicated below. Persons not in uniform will stand at attention, face the flag and place the right hand over the heart. Gentlemen, if covered, remove their headdress with the right hand and hold it at the left shoulder, so that the right hand is over the heart. When in full uniform indoors and uncovered, individuals will stand at attention.
- a. During morning colors and evening colors individuals stop and face the flagstaff, or in the direction of the music, when "*Attention*" is sounded. Salutes are rendered by individuals on the first note of the "*National Anthem*," "*To The Color*," or "*Retreat*," and terminated on the last note. Individuals would remain at attention facing the flagstaff/music until "*Carry On*" is sounded, and then continue about their duties.
- b. When being passed by or passing the national colors (standard) uncased.
- c. Small flags carried by individuals and flags flying from flagstaffs, either stands alone or affixed to a building, (except during morning and evening colors) are not saluted.
- d. A folded flag being carried to morning colors, or from evening colors, by a color detail is considered cased and not saluted.

3. By Persons in Formation

- a. During morning colors and evening colors the formation commander stops the formation and causes it to face the flagstaff, or in the direction of the music, when "*Attention*" is sounded. The formation commander salutes for the formation on the first note of the "*National Anthem*," "*To The Color*," or "*Retreat*," and terminate the salute on the last note. The formation is kept at attention facing the flagstaff/music until "*Carry On*" is sounded at which time the formation commander would move the formation to its destination or dismiss the formation.
- b. When being passed by or passing the national colors (standard) uncased, persons in formation are brought to attention and order arms if halted, or attention if marching. The formation commander shall render the salute for his unit, facing the colors if the formation is halted. Persons in formation participating in a ceremony shall, on command, follow the procedure prescribed for the ceremony.
- c. Small flags carried by individuals and flags flying from flagstaffs, either stands alone or affixed to a building, (except during morning and evening colors) are not saluted.
- d. A folded flag being carried to morning colors, or from evening colors, by a color detail is considered cased and not saluted.

Enclosure (1)



4. By Occupants of Vehicles. During morning colors or evening colors or when being passed by or passing an uncased national colors, all vehicles in motion will be brought to a halt. Persons riding in such vehicles shall remain seated at attention until colors are over or the color has passed.

7004. COMPOSITION OF THE COLOR GUARD

- 1. The standard Marine Corps color guard consists of four individuals of approximately equal height. Two noncommissioned officers are the color bearers and two other members, junior to the color bearers, are the color guards. The senior color bearer carries the national colors and commands the color guard. The junior color bearer carries the organizational colors, which is always on the left of the national colors. (See figure 7-4a.) If a female is part of the color guard she wears trousers, and not a skirt, for uniformity. When designating the uniform for the color guard, consideration should be given to the effect that the color bearers' slings may have on ribbons and badges. Slings are adjusted so that the colors are the same height when at the carry or, if this isn't possible, the national colors are slightly higher than the organizational colors. If necessary, have the senior color bearer slightly taller than the organizational color bearer. All members of the color guard wear the pistol belt (white belt if in blues); the color bearers wear the pistol belt over the sling to keep the sling firmly in place. If the color guard is wearing the service cover, then they use two chin-straps. One is worn normally and the second one is worn under the chin. When only the national colors is carried, the color guard will include only one color bearer.
2. Color guards carrying the Navy and Marine Corps service colors will consist of five members, three Marines and two Navy members. The national color bearer and commander of the color guard will be a Marine. (See figure 7-4b.)
3. A Joint Armed Forces Color Guard will consist of eight members; three Army, two Marine, one Navy, one Air Force, and one Coast Guard. The national color bearer and commander of a joint color guard will be a soldier. The respective service colors are aligned to the left of the national colors per DoD directives. (See figure 7-4c.) For color guards involving service academies, reserve or National Guard colors, refer to chapter 14, for the proper precedence.
4. Massed colors is when a regimental or larger unit commander desires to have all of that command's subordinate colors in the color guard. The first rank of massed colors consists of the two riflemen, the national colors and the colors of the senior unit present. This is the senior color guard. The remainder of the organizational colors form ranks of four behind the first rank, by seniority, from the color guards right to left. (See figure 7-4e.) Odd numbered colors are placed by seniority, and are filled in from right to left. (See figure 7-4d.) During parades and ceremonies when the colors are brought forward, only the first rank, senior color guard, marches forward. If colors are to be trooped, the senior color guard only is trooped. The remainder of the massed colors marches on with the unit to their position in the line of troops, leaving space for the senior color guard.
5. The national colors of foreign countries will not be carried by the same color guard carrying the United States colors. When necessary, a separate color guard, consisting of one noncommissioned officer and two enlisted, will be formed to carry foreign colors.
6. The flags or banners of non-U.S. military organizations (e.g., Boy Scouts, Kawanas Club, etc.) are not carried in the color guard.

Enclosure (1)

7. Color guards armed with rifles will be trained to execute a modified rifle manual. This involves pauses on the part of one or the other riflemen so that the rifles move to and from the right and left shoulders at the same time, as described in paragraph 7005.

8. The color guard is formed and marches in one rank at close interval with the color bearers in the center. While marching, members of the color guard do not swing their free arms. The color guard does not execute to the rear march, about face, flanking movements or fix bayonets. When the unit to which the color guard is attached executes any such commands, the senior color bearer orders a movement appropriate for the color guard.

9. The color bearers are unarmed, but the color guards carry either pistols or rifles (except when inside a chapel). Only color guards mounted on horseback carry the noncommissioned officer's sword vice a rifle or pistol. When participating in a ceremony inside a chapel, the color guard will be unarmed and uncovered.

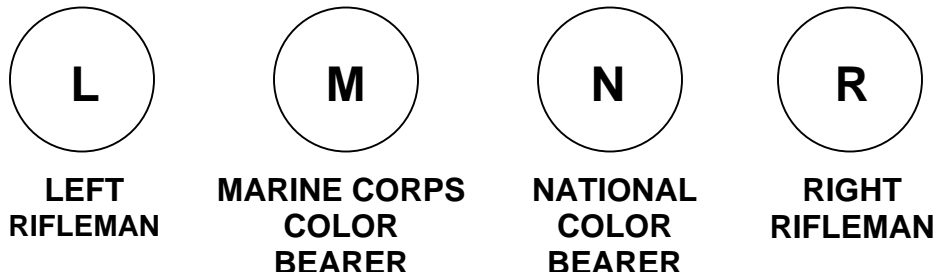

a. Marine Corps Color Guard.

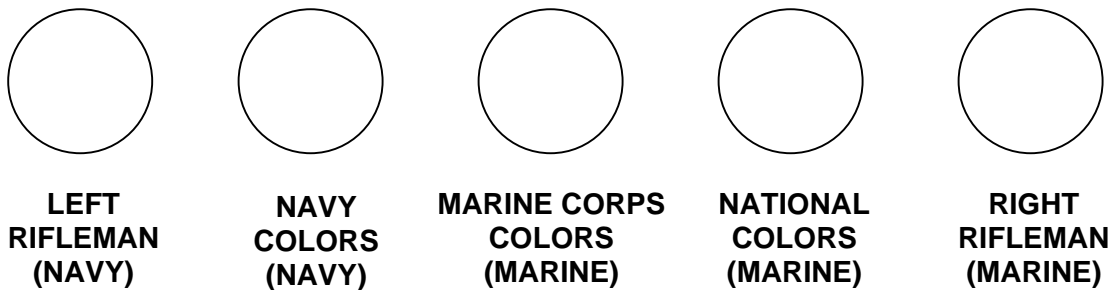

b. Navy and Marine Corps Color Guard.

Figure 7-4.--Color Guard Composition.

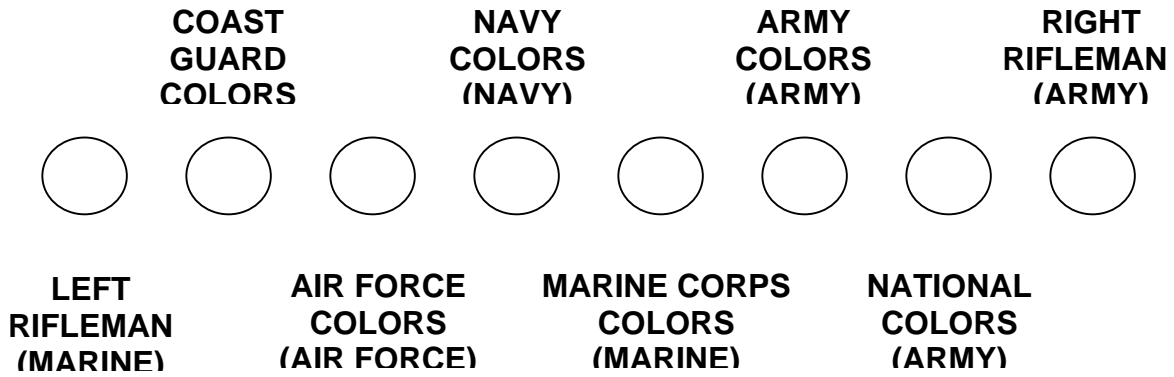

c. Joint Armed Services Color Guard.

## INF REGT

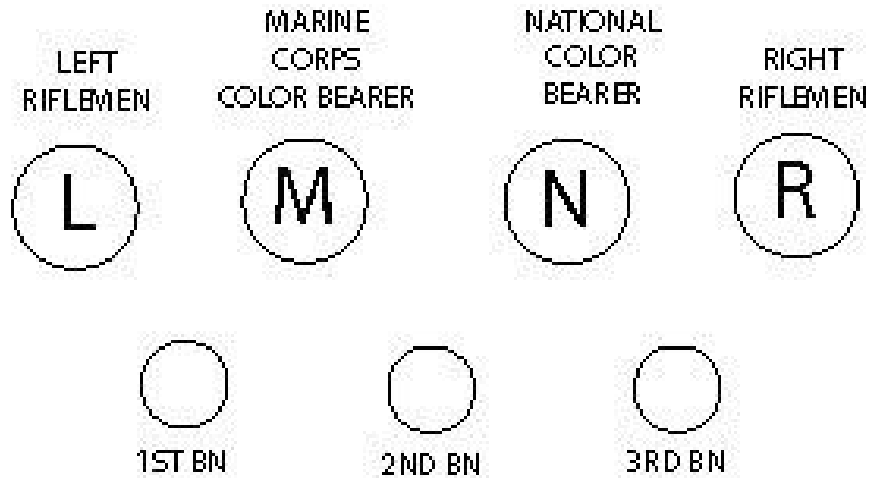

d. Placement of Odd Numbered Colors in a Massed Color Guard.  
(Using a Marine Regiment as an example)

Figure 7-4.--Color Guard Composition--Continued.

### Division Color Guard

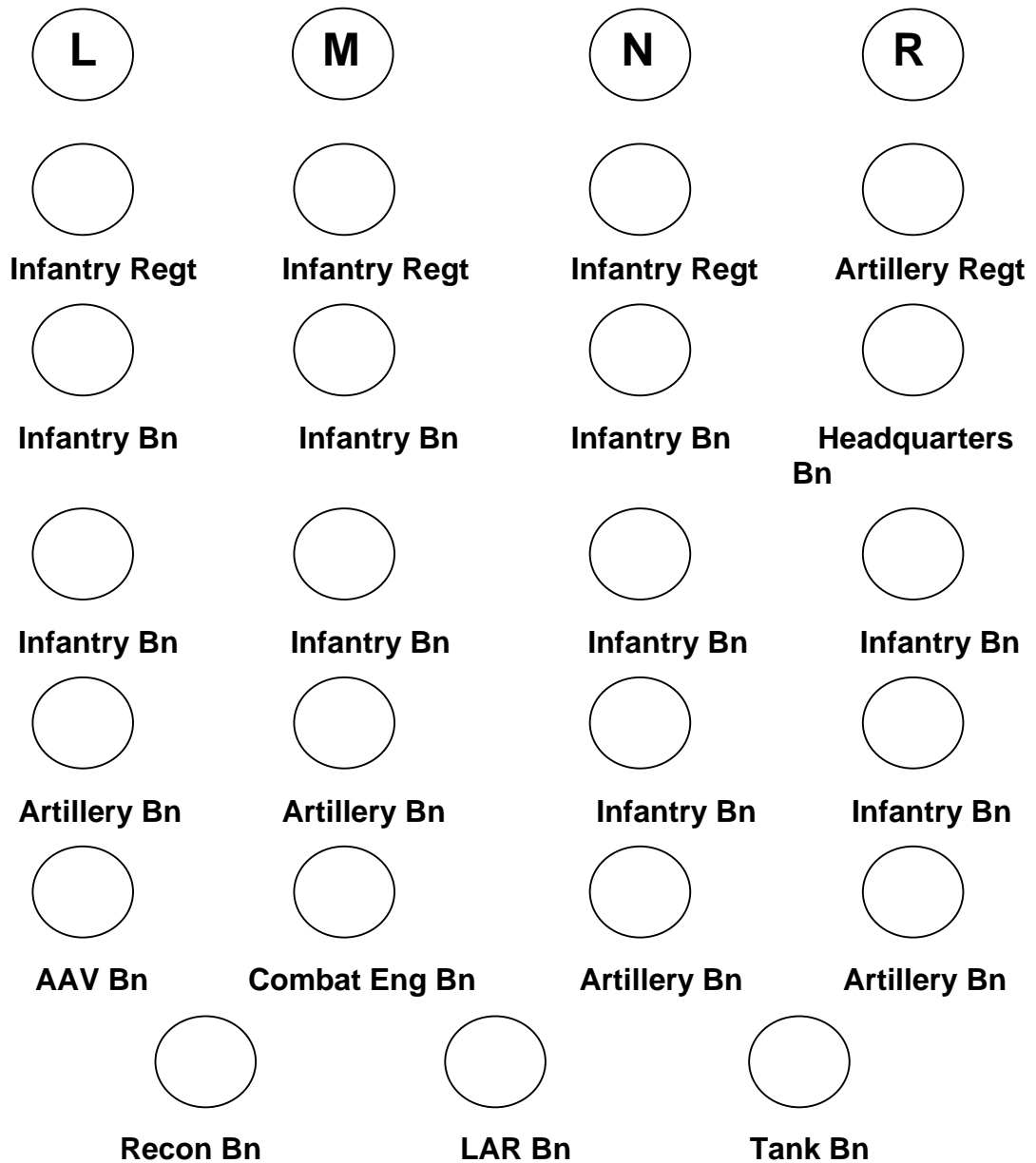

e. Massed Colors.

(Using a Marine Division as an example)

Figure 7-4.--Color Guard Composition--Continued.

10. All colors carried by the color guard are attached to staffs of equal height. The standard color staff consists of a 9 1/2-foot, hardwood pole capped at each end by metal ferrules. The use of the all-metal staff is only authorized for Marine Barracks, Washington, DC. A metal spearhead screws into the top of the staff and a streamer attachment device may also be affixed to display an organization's award streamers. (See figure 7-5.) Streamers are placed with the senior streamer at the front of the staff. Subsequent streamers are then placed clockwise, around the staff, as symmetrically as possible.

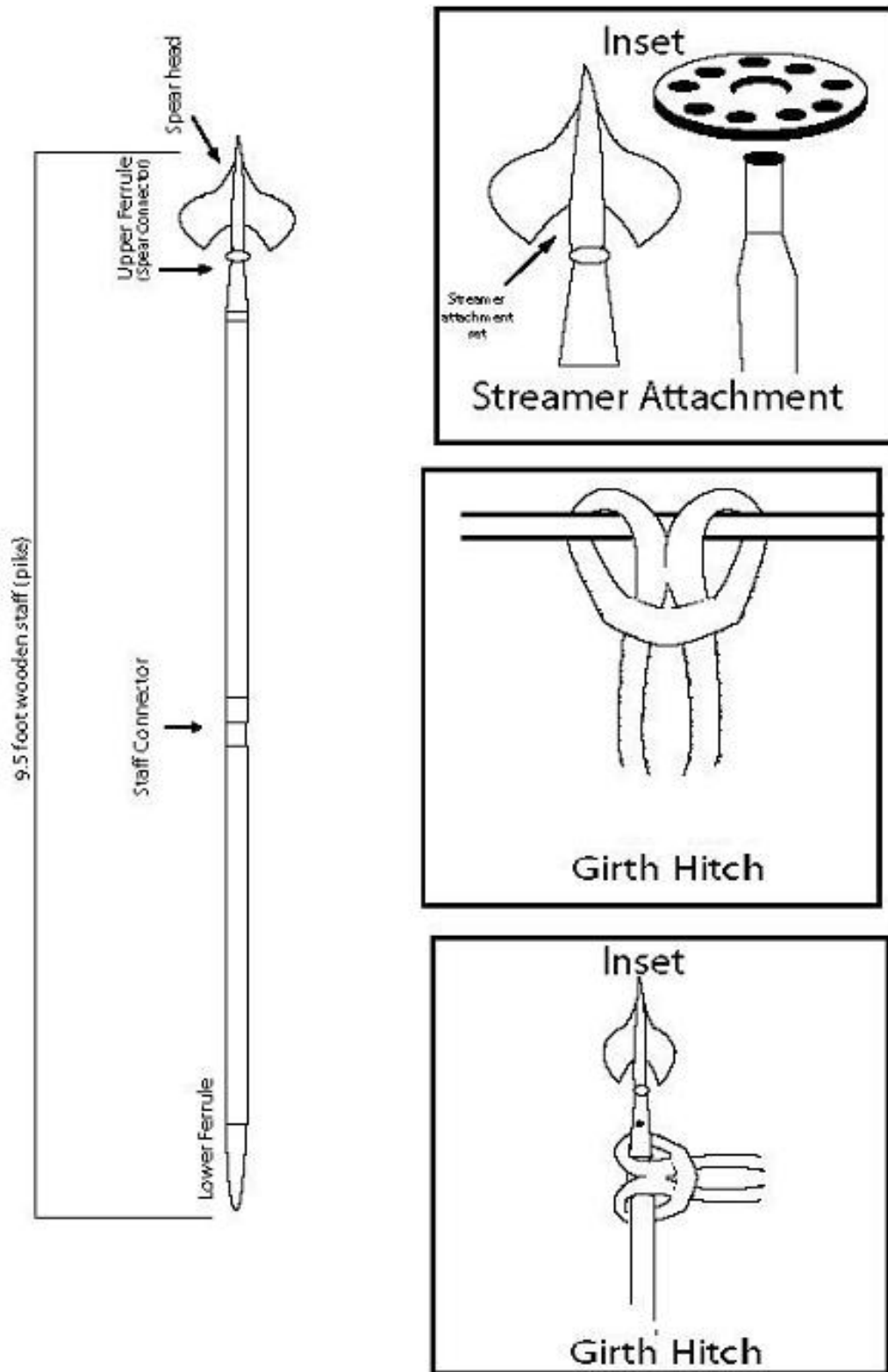

Figure 7-5.--The Color Staff.

7005. SYNCHRONIZING THE MANUAL OF ARMS FOR THE COLOR GUARDS ARMED WITH RIFLES

1. The manual of arms for color guards armed with rifles must be synchronized so that the rifles move (e.g., off of or to the shoulder) at the same time. Since the left rifleman is at left shoulder arms and the right rifleman is at right shoulder arms, moving to and from the right/left shoulder to the order, present or back the shoulder often involves different "counts" in the movement for each rifleman. To get the rifles moving together one or the other of the riflemen will have to do an occasional pause in the manual of arms so the other rifleman may catch up. When executing the rifle manual, both riflemen will wait for the senior color bearer's command of **"Ready, CUT"** before executing the final count of the movement.

a. Order Colors to Carry Colors. The command is **"Carry, COLORS."** This is a four-count movement for both riflemen. The right rifleman goes to right shoulder arms and the left rifleman goes to the left shoulder arms.

b. Carry Colors to Order Colors. The command is **"Order, COLORS."** This is a four-count movement for the right rifleman and a five-count movement for the left rifleman. In order to have the rifles move to the order together, the "counts" are modified as follows: (See figure 7-6.)



a. Start.



b. Count One.  
 Right Rifle Stands Fast. Left Rifle, Re-grasps the Small of the Stock.

Figure 7-6.--Carry Colors to Order Colors.



c. Count Two.  
Both Rifles Moved from the Shoulder.



d. Count Three.  
Both Riflemen Re-grasp the Barrel.



e. Count Four.  
Both Rifles Moved to the Right Side.



f. Count Five.  
Ready Cut.

Figure 7-6.--Carry Colors to Order Colors--Continued.

c. Order Colors to Present Colors. The command is **"Present, COLORS."** This is a two-count movement for both riflemen, with both executing present arms with the rifle.

d. Present Colors to Order Colors. The command is **"Order, COLORS."** This is a three-count movement for both riflemen, with both executing order arms with the rifle.

e. Carry Colors to Present Colors. The command is **"Present, COLORS."** This is a three-count movement for both riflemen; however, it becomes a four-count movement to synchronize the rifles being brought from the left and right shoulder to present arms. (See figure 7-7.)



a. Start.



b. Count One.  
 Right Rifle Stands Fast.      Left Rifle, Re-grasps the Small of the Stock.

Figure 7-7.--Carry Colors to Present Color.





c. Count Two.  
Both Rifles Moved from the Shoulder.



d. Count Three.  
Right Rifle Re-grasps the Small of the Stock. Left Rifle, Stands Fast.



e. Count Four.  
Both Rifles Rotated to Present Arms.

Figure 7-7.--Carry Colors to Present Color--Continued.

f. Present Colors to Carry Colors. The command may be **"Carry, COLORS"** or **"Shoulder, ARMS."** This is a three-count movement for the left rifleman and a four-count movement for the right rifleman to return the weapons to the left and right shoulder from present arms. (See figure 7-8.)



a. Start.



b. Count One  
Both Rifles Rotated to Port Arms.



c. Count Two.  
Right Rifle, Grasps Left Rifle,  
the Butt of the Rifle. Stands Fast.



d. Count Three.  
Both Rifles Moved to the Shoulder.

Figure 7-8.--Present Colors to Carry Colors.



e. Count Four.  
Ready Cut.

Figure 7-8.--Present Colors to Carry Colors--Continued.



CHAPTER 7

NATIONAL AND ORGANIZATIONAL FLAGS

SECTION 1: MANUAL OF THE COLORS

7100. ORDER COLORS

1. At order colors, the lower ferrule rests on the deck touching the outside edge of the right shoe. The staff is gripped in a strong grip with the thumb wrapped around the front of the staff with the fingers wrapped to the rear. The right elbow is held close to the side so the forearm will help support the staff. The upper staff rests in the hollow of the right shoulder. The staff is vertical with the flat side of the spearhead facing front. The color bearer is at attention. (See figure 7-9.)

2. Color guards armed with rifles are at order arms when the colors are at the order.



Figure 7-9.--Order Colors.

7101. CARRY COLORS FROM ORDER COLORS

1. When changing from order colors to carry colors, the command is **"Carry, COLORS."**
  2. At the Command **"Carry,"** change the grip on the staff to the "V" grip so as to grip it from the rear between the thumb and fingers of the right hand with the fingers around the staff.
  3. At the command **"COLORS,"** raise the staff smartly with the right hand to a point where the lower ferrule is just above the sling socket. While raising it, keep the staff vertical. Grasp the staff at the lower ferrule with the left hand to steady it and align it with the sling socket. Do not look down.
- NOTE: All organizational colors will be raised to the carry with the national colors.
4. Seat the lower ferrule in the sling socket. As the ferrule is seated, permit the right hand to slide down the staff to a position directly in front of the color bearer's chin. (See figure 7-10a.)
  5. Color guards armed with rifles execute right and left shoulder arms at the command **"COLORS"** so that the rifles are on the outboard shoulders as described in paragraph 7005.
  6. All members of the color guard will halt their movements before executing the last count. (See figure 7-10b.) On the senior color bearer's command **"Ready, CUT,"** all members will move their free hands smartly to their sides. (See figure 7-10c.) If the color staffs need additional support due to high winds, the color bearers will grip the staff with their left hands just below their right.



a. Raising Staff Seating the Ferrule.

Figure 7-10.--Carry Colors from Order Colors.



b. Last Count.



c. Carry Colors.

Figure 7-10.--Carry Colors from Order Colors--Continued.

7102. ORDER COLORS FROM CARRY COLORS

1. When changing from carry colors to order colors, the command is **"Order, COLORS (ARMS)."** Execution is begun on the preparatory command.
- 2. At the command **"Order,"** grip the staff with the left hand above the ferrule and remove the staff from the sling socket. The staff remains centered on the body with the ferrule just forward of the sling socket. (See figure 7-11a.)
- 3. At the command **"COLORS,"** lower the staff to a point approximately 2 inches above the deck along the outside edge of the right shoe; release the staff with the left hand and re-grip it above the right hand. (See figures 7-11a and 7-11b.)
4. Relax both hands so the staff will slide down until the ferrule rests on the deck. Then trim or strip the colors by maintaining a grip on the staff with the left hand and raising the right hand to lightly grasp the fabric of the colors. Pull it down along the staff (do not attempt to throw or tuck it) and re-grip the staff with the right hand, with the fabric under the right arm. (See figures 7-11c and d.) Then change the position of the right hand to that described for order colors.
5. Color guards armed with rifles will execute order arms from right and left shoulder as described in paragraph 7005.1a. All members of the color guard will halt their movements before executing the last count. The senior color bearer will then command **"Ready, CUT,"** at which time all members of the color guard will return their left hands smartly to their sides and color guards will assume order arms. (See figure 7-11e.)



a. Removing the Ferrule.

Figure 7-11.--Order Colors from Carry Colors.

Enclosure (1)

7-28

Ch 1





b. Lowering the Staff.



c. Trimming the Colors.

Figure 7-11.--Order Colors from Carry Colors--Continued.



d. All Movement Halted.



e. Movement Complete.

Figure 7-11.--Order Colors from Carry Colors--Continued.

7103. PRESENT COLORS FROM ORDER COLORS

1. To change from order colors to present colors the command is **"Present, COLORS (ARMS)."** Execution is begun on the preparatory command.
2. At the command **"Present,"** change the grip on the staff in the same manner as for carry colors. **The national color bearer executes the movement to carry colors.**
3. At the command **"COLORS,"** organizational color bearer executes the movement to carry colors. The color guards execute present arms. (See figure 7-12.)
4. On the senior color bearer's command **"Ready, CUT,"** only the color bearers will move their left hands smartly to their sides.



Figure 7-12.--Present Colors from Order Colors.

7104. SALUTES BY THE ORGANIZATIONAL COLORS

1. Once the color guard is at present colors, and when appropriate, the organizational color bearer will render a salute with the organizational colors by straightening the right arm and lowering the staff naturally to the front. The staff will rotate naturally as it goes forward causing the sharp edge of the spearhead to face down. (See figure 7-13.)
2. Salutes by the organizational colors are not automatic when presenting colors. They will be rendered only during honors to national colors, to the commander of the organization represented by the colors or to an individual senior in rank to the organizational commander. (e.g., during a parade or review when the adjutant presents the command to the commander of troops, the organizational colors does not salute, unless the commander of troops is the organizational commander or of higher rank.)
3. When musical honors are played, the organizational colors will salute on the first note of music. The colors will be returned to the vertical position following the last note of music or the last volley of a gun salute. If no music is to be played and a color salute is appropriate, the organizational colors will salute immediately after the color guard has gone to present colors.
4. When marching, the salute is rendered when 6 paces from the reviewing stand or person to be saluted. Carry colors is resumed when 6 paces beyond the reviewing stand or person to be saluted.



Figure 7-13.--Salutes by the Organizational Colors.

7105. ORDER COLORS FROM PRESENT COLORS

1. When changing from present colors to order colors, the command is **"Order, COLORS (ARMS)."**
- 2. At the command **"Order,"** if the organizational colors are still saluting, it will be brought back to the vertical position with the flat side of the spearhead facing the front. The color bearers then grip the staff with the left hand above the ferrule and remove the staff from the sling socket. The staff remains centered on the body with the ferrule just forward of the sling socket.
3. At the command **"COLORS,"** all colors are brought to the position of order colors. Color guards execute order arms from the shoulder as described in paragraph 7005.1a. Colors are trimmed, if necessary, and the command **"Ready, CUT"** is given in the same manner as for order colors from carry colors.

7106. PRESENT COLORS FROM CARRY COLORS

1. To change from carry colors to present colors, the command is **"Present, COLORS (ARMS)."**
2. At the command of execution **"COLORS,"** the color guards execute present from the shoulder as described in paragraph 7005.1d.
3. The national color bearer remains at carry colors.
4. The organizational color will salute if appropriate.

7107. CARRY COLORS FROM PRESENT COLORS

1. To change from present colors to carry colors, the command is **"Carry, COLORS."**
2. At the command **"Carry,"** if the organizational colors are saluting, it will be brought back to the vertical position with the flat side of the spearhead facing the front.
3. At the command **"COLORS,"** color guards return to the shoulder as described in paragraph 7005.1f. Before executing the last count, the color guards will await the senior color bearers command **"Ready, CUT."**

7108. RESTS WITH THE COLORS

1. The color guard assumes the parade rest position in lieu of at ease or rest. At ease or rest are not used by the color guard when carrying uncased colors. Only the senior color bearer or person in charge of a formation with which colors are posted gives the command from the position of order color. It is executed in one count.
2. At the command **"Parade, REST;" "AT EASE;"** or **"REST,"** all members of the color guard execute parade rest. The color staff will remain along the color bearer's side and will not be thrust forward as with a guidon staff. (See figure 7-14.) The national and organizational colors bearers will grasp the sling socket with their left hand.

Enclosure (1)



a. Front View.



b. Rear View.

Figure 7-14.--Color Guard at Parade Rest.

7109. EYES RIGHT (LEFT) FROM CARRY OR ORDER COLORS

1. The command is **"Eyes, RIGHT (LEFT)."** It will be given only when marching at carry colors or while halted at order colors.
2. When marching at carry color, at the command **"RIGHT,"** all members of the color guard except the national color bearer and the individual on the right turn their head and look 45 degrees to the right. When the reviewing officer of a parade is entitled to a salute by the organizational colors, the salute is executed at the command **"RIGHT."** (See figure 7-15b.)
3. When marching at carry color, at the command **"LEFT,"** all members of the color guard except the national color bearer and the individual on the extreme left turn their head and look 45 degrees to the left. When the reviewing officer of a parade is entitled to a salute by the organizational colors, the salute is executed at the command **"LEFT."**
4. When halted at order color, at the command **"RIGHT,"** all members of the color guard except the national color bearer turn their head and look 45 degrees to the right. (See figure 7-15a.) The organizational color cannot salute from order color.
5. When halted at order color, at the command **"LEFT,"** all members of the color guard except the national color bearer turn their head and look 45 degrees to the left. The organizational color cannot salute from order color.



Figure 7-15a.--Eyes Right, Halted.



Figure 7-15b.--Eyes Right, Marching.

7110. CARRY OR ORDER COLORS FROM EYES RIGHT (LEFT)

1. The command is **"Ready, FRONT."**
2. When marching at carry colors, at the senior color bearer's command **"Ready,"** if the organizational colors saluted, it resumes to the carry. At the command **"FRONT,"** all members of the color guard who executed eyes right (left) will return their head and eyes smartly to the front.
3. When at order colors during a review when the reviewing officer troops the line, ready front will not be given after eyes right. During such a ceremony, members of the color guard who executed eyes right, will follow the reviewing officer with their eyes, turning their heads back toward the front as he passes by. Once the reviewing officer is directly in front of them, all movement of the head and eyes is halted.



7111. TRAIL ARMS WITH THE COLORS

1. When performing indoor ceremonies in a location that the doors, ceilings, etc. are not high enough to carry colors in the normal manner, the colors would be carried at the trail.
  2. Trail arms is assumed without command on any command that will cause the color guard to move. (e.g., **"Forward, MARCH;"** **"Right Turn, MARCH;"** etc.)
  3. Color bearers, on the preparatory command, raise the staff 6 inches off the deck. Color guards assume trail arms. (See figure 7-16.)
  4. On the command of execution, step off and move a short distance until given the command to halt.
- NOTE: If necessary to lower the colors to clear a doorway reach across the body with the left hand and grasp the colors. Left forearm is straight and parallel to the deck, with the palm to the rear. All colors are tilted forward sufficiently to clear the door or ceiling spearhead flat to the front.
5. When the command to halt is given the color bearers return the colors to the order and move the left arm back to the left side. Color guards armed with rifles return to the order.



Figure 7-16.--Marching at Trail Colors.



## CHAPTER 7

## NATIONAL AND ORGANIZATIONAL FLAGS

## SECTION 2: MOVEMENTS OF THE COLOR GUARD.

7200. FACE THE COLOR GUARD TO THE RIGHT (LEFT)

1. The command is "**Right (Left) Turn, MARCH.**" It may be executed while halted, marking time, or marching.

2. On the command "**MARCH,**" with the right (left) flank color guard acting as a stationary pivot, the color guard turns to the right (left) while half stepping until they face the new direction. When making the turn, all members of the color guard face the same direction maintaining their alignment. (See figure 7-17.) Upon completion of the turn, the color guard will be marking time. The senior color bearer must immediately give the next appropriate command, such as "**Forward, MARCH**" or "**Colors, HALT.**"

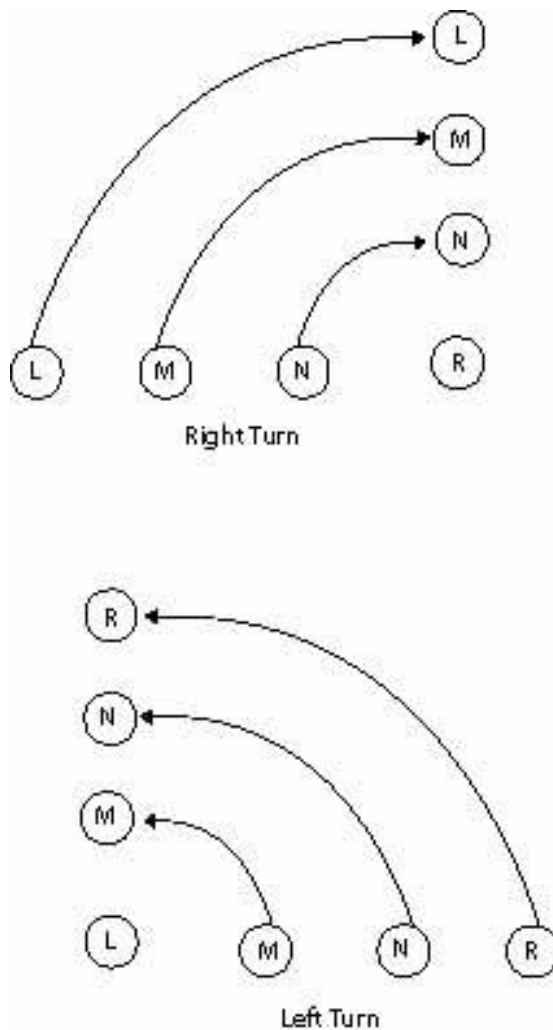

Figure 7-17.--Right (Left) Turn.

7201. FACE THE COLOR GUARD TO THE REAR

- 1. The command is "**Countermarch, MARCH.**" It may be executed while halted, marking time, or marching. When marking time or marching, the command of execution "**MARCH**" is given as the left foot strikes the deck. When this command is given while marking time or marching, the color guard will take one more 2-inch vertical step in place or one more 30-inch step forward with the right foot before starting the half steps for this movement. If executed from the halt, the color guard will immediately begin the designated steps starting with the left foot. (See figure 7-18.)
2. The national color bearer pivots to the left, moving into the position formerly occupied by the organizational color bearer, facing the new direction of march and begins marking time.
3. The organizational color bearer takes one half step forward, pivots to the right outside the national color bearer, moving into the position formerly occupied by the national color bearer, facing the new direction of march and begins marking time.
4. The right color guard takes two half-steps forward, pivots to the left, outside the organizational color bearer, moving into the position formerly occupied by the left color guard, facing the new direction of march and begins marking time.
5. The left color guard takes three half-steps forward, pivots to the right outside the right color guard, moving into the position formerly occupied by the right color guard, facing the new direction of march and begins marking time.
6. Upon completion of this movement, the entire color guard marks time until it is halted or until it receives the command "**Forward, MARCH**" or "**Colors, HALT.**"

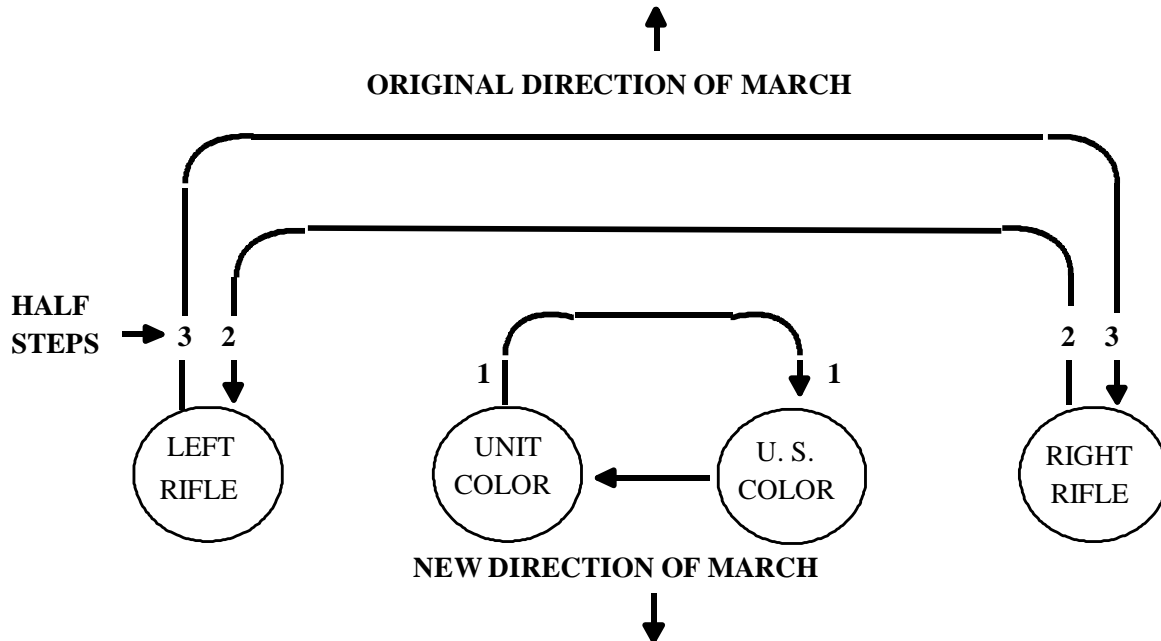

Figure 7-18.--Countermarch.

Enclosure (1)

7202. MOVEMENTS UTILIZED BY JOINT COLOR GUARDS (JCG). JCGs use two basic movements to turn the color guard 90 or 180 degrees. These are the **"Right (Left) Wheel, MARCH"** and the **"Left About, MARCH."**

7203. RIGHT (LEFT) WHEEL. This movement is used to turn the JCG 90 degrees right or left and may be executed either from the halt, mark time, or quick time. In JCGs with an even number of members, the pivot point will be between the two, center color bearers. In JCGs with an odd number of members, the pivot point will be the spot occupied by the center color bearer.

1. On the command of execution **"MARCH,"** the JCG will start marking time. At the same time, they will begin to turn slowly to the right/left while maintaining their alignment. For **"Right Wheel,"** those to right of the pivot back step and those to the left half step until facing the new direction. This procedure is reversed for **"Left Wheel."**

2. Once facing the new direction of march (90 degrees), the JCG will either halt or step off in the new direction, depending on commands by the senior color bearer.

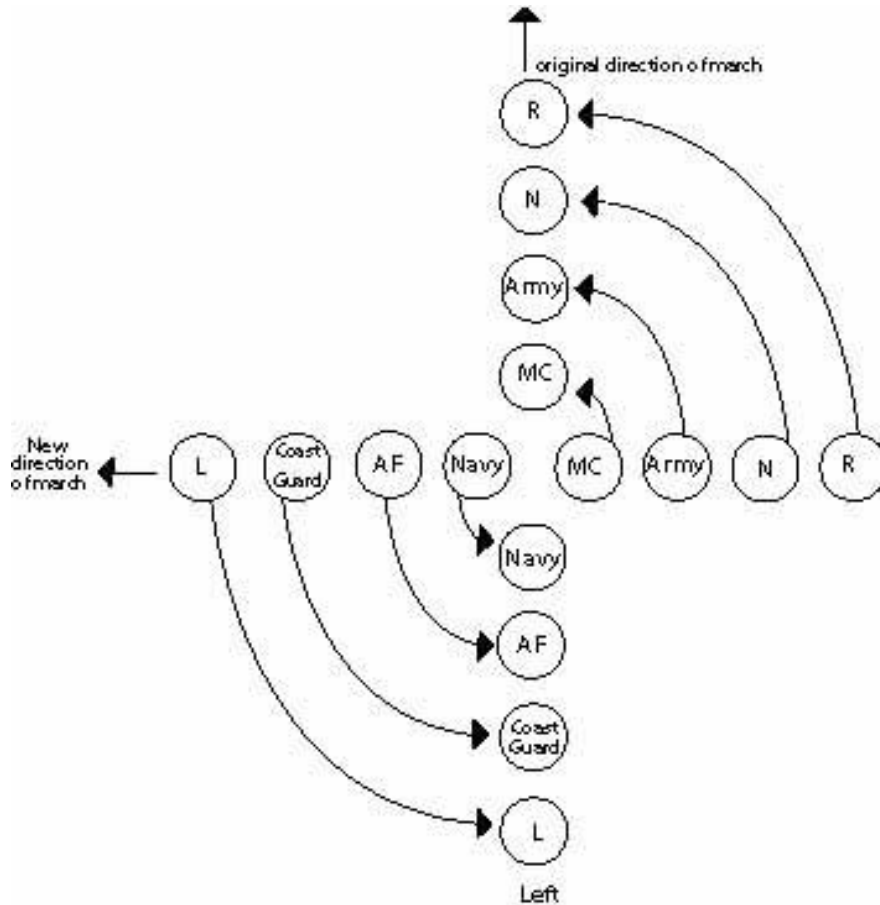

a. Pivot with Even Number.

Figure 7-19.--Right (Left) Wheel About.

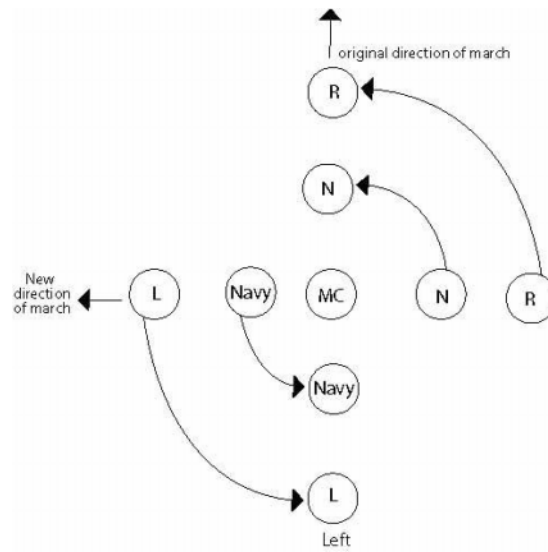

b. Pivot with Odd Number.

Figure 7-19.--Right (Left) Wheel About--Continued.

7204. LEFT ABOUT. This movement is used to turn the JCG 180 degrees, and it may also be executed while halted, marking time, or quick time. On the command of execution "**MARCH**" it is executed in the same manner as above. The only exceptions are the pivot point; the degree of turn and it is only executed to the left.

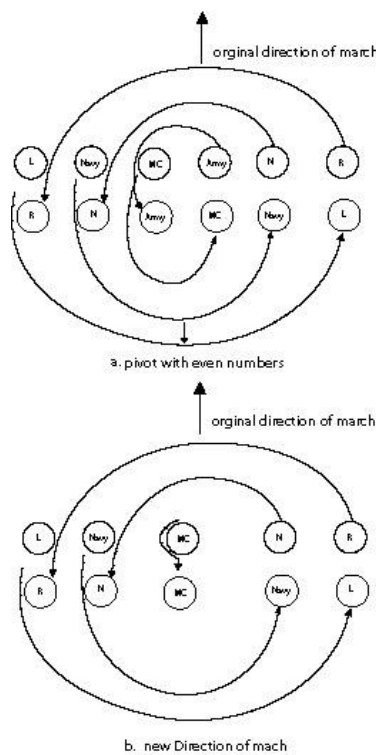

Figure 7-20.--Left About.

## CHAPTER 7

## NATIONAL AND ORGANIZATIONAL FLAGS

## SECTION 3: COLOR GUARD PROTOCOL

7300. GENERAL. The primary mission of the color guard is to ensure that the national colors is handled and displayed with the utmost care and respect. Upon receiving or uncasing the national colors, the color guard assumes a ceremonial posture; meaning that all movement will be by marching at attention and the most relaxed halted position will be parade rest.

7301. RECEIVING THE COLORS BY THE COLOR GUARD. The color guard will use the following procedure in receiving the colors: (See figure 7-21.)

1. The color guard forms and marches to the place designated for receiving the colors.
2. The color guard is halted 3 paces from the adjutant and sergeant major that have taken appropriate positions for the delivery of the colors to the guard.
3. The senior color bearer commands the color guard to **"Order, ARMS."**
4. When the adjutant is ready to deliver the colors, the senior color bearer orders **"Present, ARMS."** At this command, the color bearers execute a hand salute, the color guards present arms.
5. The adjutant steps to the left oblique and transfers the national colors to the senior color bearer, who terminates salute in time to receive it at the position of carry colors. The adjutant then steps back and salutes.
6. Upon the adjutant's salute, the sergeant major, steps to the right oblique and transfers the organizational colors to the junior color bearer, who terminates salute in time to receive it at the position of carry colors. The senior enlisted then steps back and salutes.
7. When the senior enlisted salutes, the senior color bearer commands **"Order, ARMS."** The adjutant and senior enlisted terminate their salutes and the command of **"ARMS"** and march off.
8. The senior color bearer then marches the color guard to the color company (battalion).

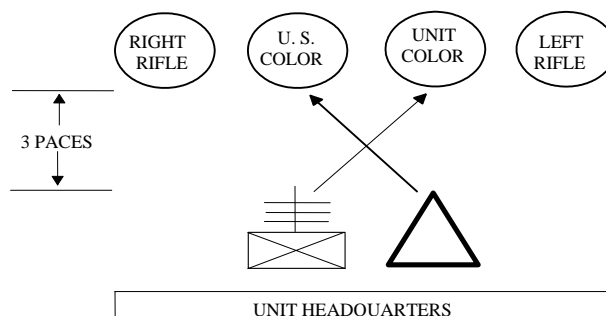

Figure 7-21.--Receiving/Returning the Colors by the Color Guard.

7302. RECEIVING THE COLORS BY THE COLOR COMPANY (BATTALION). Prior to forming for a ceremony in which the colors are to participate, the colors are to participate, the colors are received by the color company (battalion) by means of the following ceremony: (See figure 7-22.)

1. The company (battalion) is formed with its commander facing front.
2. The color guard approaches and halts 10 paces in front of and facing the company (battalion) commander remaining at the carry.
3. The company (battalion) commander faces about, towards the unit, and orders **"Present, ARMS."** The color guard executes present arms on the company (battalion) commander's command. The organizational colors salutes, if appropriate. The company (battalion) commander faces about again and salutes the colors.
4. The company (battalion) commander terminates salute, faces about, and commands **"Order, ARMS."** The color guard returns to the carry.
5. The company (battalion) commander faces about and orders the color guard to **"POST THE COLORS."** When the color company (battalion) is in line or mass, the post of the guard is 6 paces to the left of the company (battalion). When the company (battalion) is in column, the post of the guard is 6 paces behind.
6. When the color company (battalion) joins the formation, the color guard takes its appropriate post centered in the formation.
7. When in formation, the color guard executes parade rest when the color company (battalion) executes at ease or rest. The color guard will respond to all commands from the commander of troops or the commander of the color company (battalion) except when required by its unique movements to act independently.

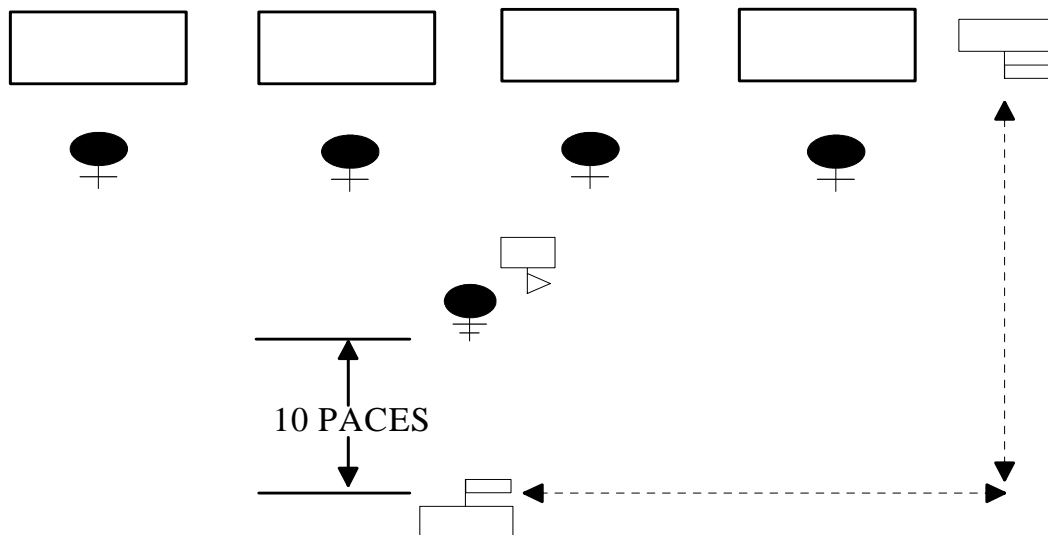

Figure 7-22.--Receiving/Returning the Colors by the Color Company.



7303. DISMISSING THE COLOR GUARD. In dismissing the color guard at the conclusion of a drill or ceremony, the procedure is as follows: (See figure 7-22.)

1. The guard marches from its post and halts 10 paces in front of and facing the company (battalion) commander, halts and remains at the carry.
2. The company (battalion) then executes present arms in the same manner described for receiving the colors, after which the color guard marches the colors to the quarters or office of the organizational commander.
3. The color guard is received by and dismissed from organizations smaller than a company (e.g., funeral escort) in a similar manner.

7304. RETURNING THE COLORS BY THE COLOR GUARD. The color guard will use the following procedure when parting with the colors: (See figure 7-21.)

1. The senior color bearer halts the guard 3 paces in front of the adjutant and senior enlisted who have taken positions near the office or quarters of the organization in time to receive the colors. The guard remains at carry colors.
2. When the color guard halts, the adjutant and senior enlisted salute. The Senior Enlisted, then terminates the salute and steps to the right oblique, receives the organizational colors from the junior color bearer, and then steps back.
3. The adjutant then terminates the salute and steps to the left oblique, receives the national colors from the senior color bearer, and then steps back.
4. The senior color bearer then commands "**Present, ARMS.**" The color guards execute present arms, the color bearers hand salute. The adjutant faces about and the senior enlisted passes behind him to a position on the left. They then march into the office or quarters of the commanding officer where the colors are placed without further ceremony.
5. When the colors are out of sight or 6 paces away, the senior color bearer commands "**Order, ARMS,**" and dismisses the guard or marches them back to their unit.

7305. CASING AND UNCASING THE COLORS

1. While it is not a precision movement, casing and uncasing the colors should be accomplished with appropriate dignity and ceremony.
2. To uncase the colors, the color guard will be formed at carry colors. The supernumerary or other designated individual(s) will center on the color guard. First the national color bearer and then the organizational color bearer will lower their staffs so that the cases may be removed. The individual(s) removing the cases will then step back and salute the national colors before retiring. (See figure 7-23a.)
3. To case the colors, the color guard will be formed at carry colors. The individual(s) with the cases will center on the color guard and salute the national colors. The organizational color bearer followed by the national color bearer will lower their staffs so that their colors may be furled and cased. Rather than

wrapping the colors around the staff, the colors should be folded on top of the staffs and held until the cases are slipped on. The rope and tassel and streamers, if any, are kept clear until the colors are folded onto the staff, and then are placed as flat as possible, on the colors. This may require two persons to accomplish. (See figure 7-23b.) Care should be taken to ensure that color cases fit easily over the colors. Cases constructed with too narrow of a diameter cause undue wrinkling and may even damage the colors.



a. Uncasing Colors.



b. Casing Colors.

Figure 7-23.--Uncasing and Casing Colors.

7306. TROOPING THE COLORS

1. When it is desired to highlight the unit colors and have them formally received by the entire battalion (or regiment) while forming for a review, parade, or any other ceremony, the ceremony for trooping the colors may be conducted. It is particularly appropriate to include trooping the colors as a part of ceremonies conducted to coincide with an important event in the unit's history. However, if the colors are to be brought forward for a retirement, promotion, awards or other similar type ceremony the colors should not, but may, be trooped since this would cause the command to present arms to the colors twice. (Once when the colors are trooped and once when they are brought forward for the awards or other ceremony)

2. Procedures for Trooping the Colors

a. After forming at "Assembly," the color guard receives the battalion (regimental) colors as prescribed in paragraph 7301. The color company may also receive the color guard per paragraph 7302, or the color guard may take its position on the battalion (regimental) parade deck independently. In the former case, coincidental with "Adjutant's Call," the color guard initially marches on with the color company then breaks out of formation so as to take post on the left flank of the line of troops. In the latter case, the color guard marches independently on the parade ground and takes post on the left flank of the line of troops at "Adjutant's Call," or prior to "Adjutant's Call," as appropriate. (See figure 7-24.) Regardless, after taking post on the left flank, the color guard goes to order colors.

→ b. The troops form at "Adjutant's Call" according to the commands and procedures prescribed for forming a battalion (regiment) for ceremonies, up to the point where the units complete dressing to the right, the guides are posted (if units marched on), and bayonets are fixed (if so prescribed). Then, the adjutant facing the command and posted midway between the line of company (battalion) commanders and the battalion (regimental) commander, commands "**MARCH ON THE COLORS.**" The band plays appropriate music while the color guard, coming to the carry, marches from its position on the left flank, across the front of the battalion (regiment) along a line parallel to the line of troops and midway between the adjutant and line of company (battalion) commanders. Company (battalion) commanders and the company guide (battalion staff) salute the colors as they pass their front. Those company (battalion) commanders who are not passed by the colors will not salute. On reaching a point in front of the adjutant, the color guard executes a left turn to face the adjutant and halts, remaining at the carry. The adjutant then commands "**Present, ARMS**" and salutes the colors. The unit presents arms. The color guard executes present arms from the carry. The band plays either "To the Color" or the "National Anthem." The battalion (regimental) commander and staff to salute on the first note of the music and terminate the salute on the last note. After completion of the music, the adjutant commands "**Order, ARMS.**" The color guard returns to carry color on the command "**Order, ARMS.**" The adjutant then commands "**POST THE COLORS.**" The color guard countermarches, moves to the line of troops on the left of the color company (battalion), countermarches to face the front, halts, and goes to order colors.

c. After the color guard is in position on the left of the color company (battalion), the parade or ceremony would proceed as prescribed in the appropriate chapter of this Manual.

Enclosure (1)

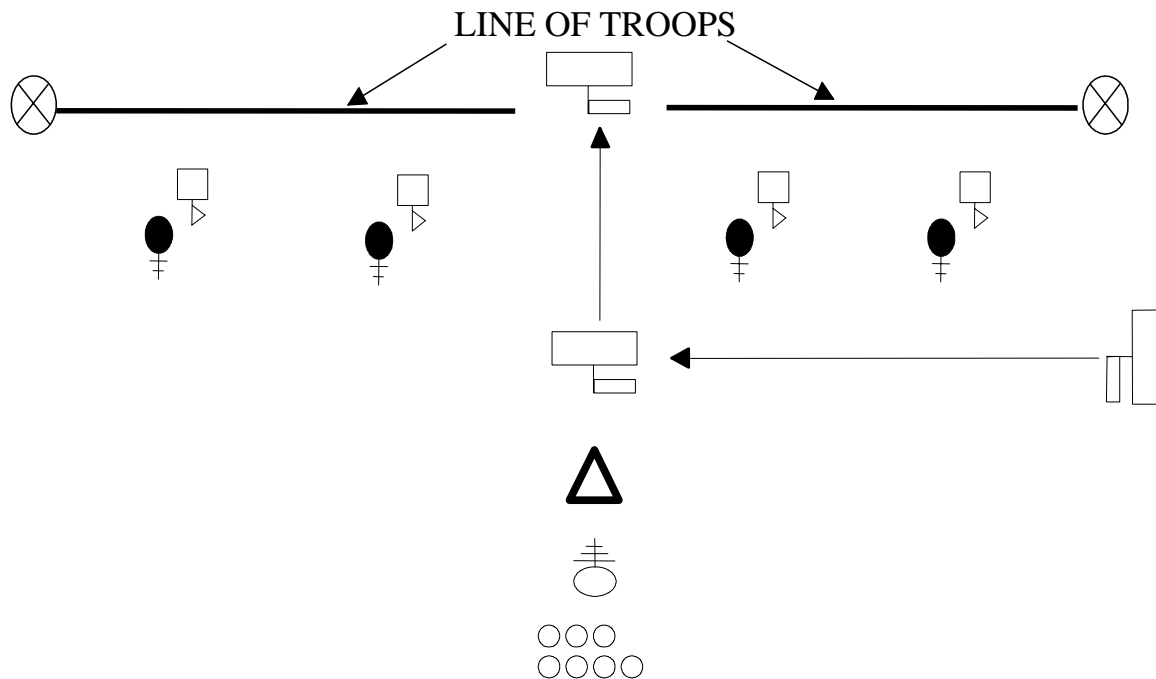

Figure 7-24.--Trooping the Colors.

#### 7307. INDOOR CEREMONIES INVOLVING COLOR GUARDS

1. On occasion color guards will be required for indoor ceremonies, military or civilian. Normally an indoor ceremony consists of marching on the colors, the "National Anthem," (or pledge of allegiance), posting the colors and retiring the colors. Close coordination with the master of ceremonies, and an on-site rehearsal (if possible) are needed to preclude confusion and misunderstandings during the ceremony.

#### 2. The Normal Sequence of Events Should be as Follow

a. The master of ceremonies asks the guests to please rise for the march on the colors and to remain standing for the "National Anthem" and the posting of the colors.

b. The color guard marches in from the designated entry and moves to its position, and does a right (left) turn or countermarch to face the audience and remains at the carry. The senior color bearer then gives the command "**Present, COLORS.**" The color guard executes. After the "National Anthem" is played the senior color bearer gives the command "**Carry, COLORS.**" The senior color bearer would then give the commands necessary to move the color guard to 3 paces in front of where the colors are to be posted, halts and gives the command to "**Order, COLORS.**" Once the color guard is at the order, the organizational color bearer then steps to the right oblique and places the organizational colors in the stand. Once the organizational color bearer is back in position the national color bearer steps to the left oblique and places the national colors into the stand. (See figure 7-25.) When the national color bearer is back in position the senior color

bearer commands **"Present, ARMS."** The riflemen execute present arms and the color bearers execute a hand salute. The senior color bearer then commands **"Order, ARMS;" "Shoulder, ARMS;"** and then using whatever commands necessary, marches the color guard from the auditorium.

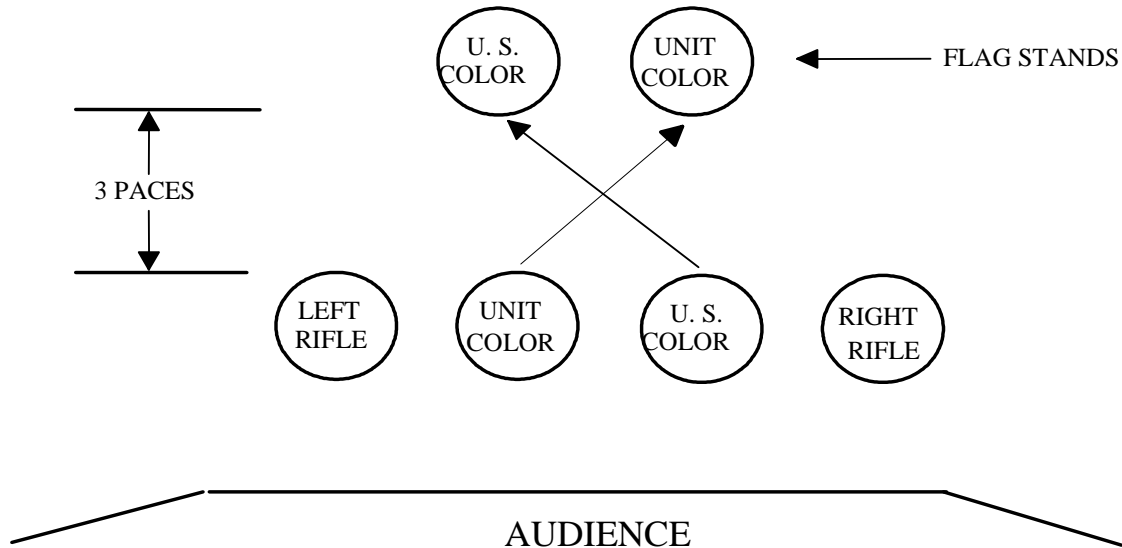

Figure 7-25.--Posting and Retrieving the Colors Indoors.

3. When it is time to retire the colors, the color guard assumes its position to re-enter the auditorium for that part of the ceremony.

a. The master of ceremonies would then ask for the guests to rise for the entering of the colors.

b. The color guard marches to a position 3 paces in front of where the colors are posted, halts and goes to the order. (See figure 7-25.) The senior color bearer then commands **"Present, ARMS,"** the riflemen execute present arms and the color bearers execute a hand salute. The senior color bearer then commands **"Order, ARMS."** The color guard goes to the order. The national color bearer then steps to the left oblique and retrieves the national colors. When the national color bearer is back in position the organizational color bearer steps to the right oblique and retrieves the organizational colors. When the organizational color bearer is back in position the senior color bearer commands, **"Carry, COLORS"** and then, using whatever commands necessary, marches the color guard from the auditorium.

4. When performing an indoor ceremony, oddities will be encountered that will necessitate some adjustments by the color guard. Some examples are:

a. If performing in a house of worship, covers are not worn and weapons are not carried. Those portions of the ceremony requiring present arms are deleted and the riflemen may be omitted.

b. The ceiling may be too low to carry colors; march in at the trail.

c. The aisles may be too narrow for a color guard to march in normal formation. The color guard would then march in by two's (See figure 7-26) or in column of ones. (See figure 7-27.) If marching in by twos then the color bearers lead and the riflemen follow. Upon reaching the spot for presenting the colors, the riflemen would step into their normal position. If marching in a column of ones the order of march is **ALWAYS**, right color guard, national color bearer, organizational color bearer, left color guard. When reaching their spot the color guard would reform. Make sure the colors don't reform inverted.

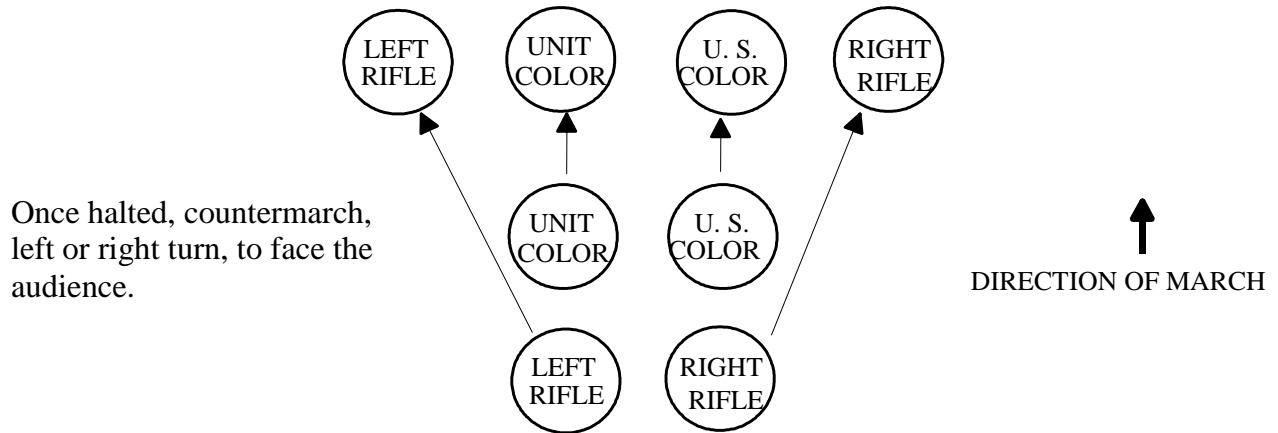

Figure 7-26.--Marching in Column of Twos and Reform.

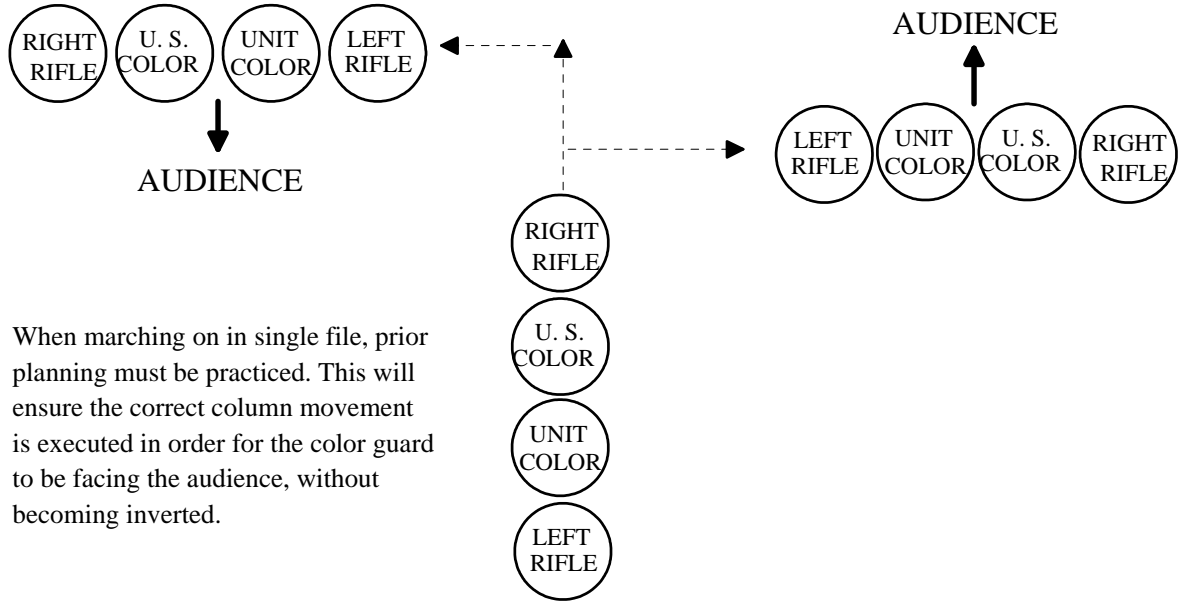

Figure 7-27.--March in Column of Ones and Reform.

d. The flag stands you will be posting the colors into may be on different sides of the stage. If this occurs, the recommended sequence is:

(1) Execute the ceremony as discussed earlier.

(2) After the "*National Anthem*" the colors countermarch and halt facing the new direction. The senior color bearer would command post the colors. The national color bearer and right rifleman step off to the left oblique and move to the flag stand and mark time. The right rifleman positions himself so as to be outboard of the national colors. After the national color bearer and right rifleman have cleared, the organizational color bearer and left rifleman step off in the right oblique and move to the flag stand and mark time. The left rifleman positions himself so as to be outboard of the organizational colors. (See figure 7-28.) Once both colors are in position the senior color bearer commands "**Colors, HALT,**" and "**Order, COLORS.**" The organizational colors is placed in the flag stand, then the national colors is placed in the flag stand. The senior color bearer then commands "**Present, ARMS.**" The riflemen execute present arms and the color bearers execute a hand salute. The senior color bearer then commands "**Order, ARMS;**" "**Center, FACE;**" and "**Forward, MARCH.**" The riflemen march at trail arms. The color guard moves to the center of the stage and marks time, slowly turning left or right towards the audience. The senior color bearer then commands, "**Colors, Halt;**" "**Shoulder, ARMS;**" and then marches the color guard from the auditorium.

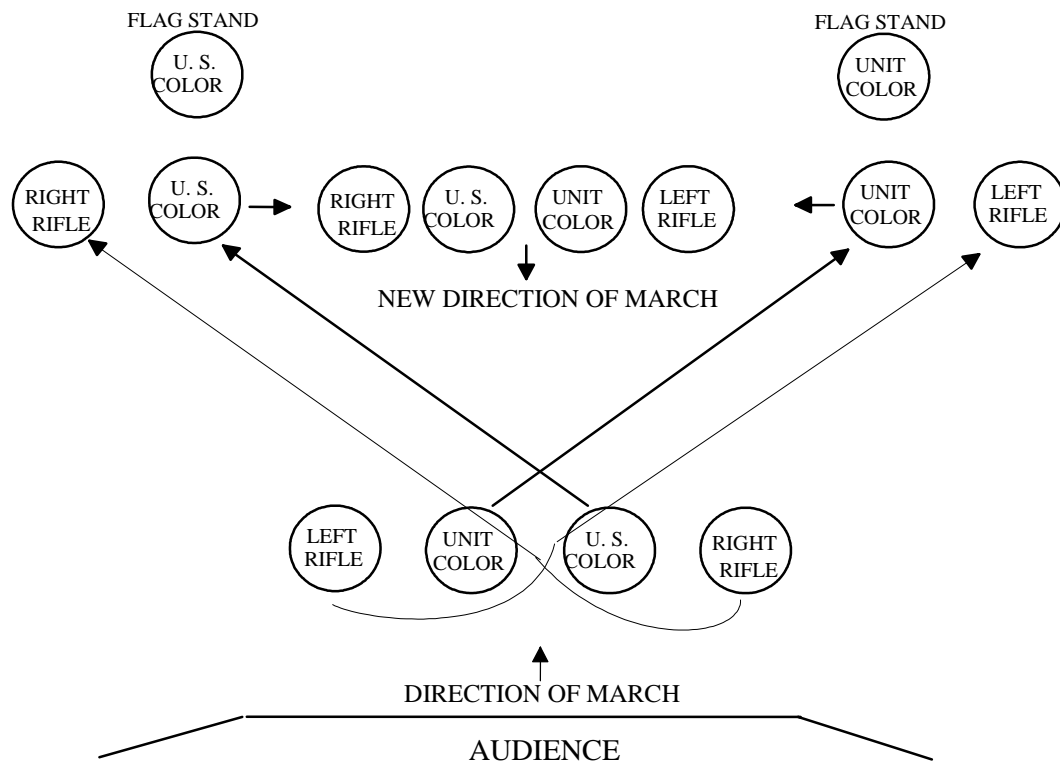

Figure 7-28.--Posting and Retrieving the Colors Indoors (Flag Stands Separated).

(3) To retire the colors from separated flagpoles, the detail is marched into position facing the colors and halts. The senior color bearer then commands **"Present, ARMS."** The color guard riflemen execute present arms and the color bearers execute a hand salute. The senior color bearer then commands **"Shoulder, ARMS."** The riflemen return to the shoulder. The national color bearer and right rifleman then step off to the left oblique and move to the flag stand and mark time. The right rifleman positions himself so as to be outboard of the national colors. After the national color bearer and right rifleman have cleared, the organizational color bearer and left rifleman step off in the right oblique and move to the flag stand and mark time. The left rifleman positions himself so as to be outboard of the organizational colors. (See figure 7-25.) Once all are in position the senior color bearer commands **"Colors, HALT,"** and **"Order, ARMS."** The senior color bearer then retrieves the national colors. The organizational color bearer then retrieves the organizational colors. The senior color bearer then commands **"Center, FACE,"** and **"Forward, MARCH."** The color guard, at trail arms, moves to the center of the stage and marks time, slowly turning left or right towards the audience. The senior color bearer then commands **"Colors, HALT;"** **"Carry, COLORS;"** and then marches the color guard from the auditorium.

e. The rule of thumb for all unusual situations not covered by this Manual is to perform in a military manner. However, never do something that would embarrass the Corps.

#### 7308. ORDERING COLORS, STAFFS AND OTHER CEREMONIAL GARRISON PROPERTY

1. Instructions for ordering flags, streamers, guidons and other heraldic items is found in MCO P10520.3B, section G. The list in appendix C contains the description, and National Stock Numbers of flags, staffs and other color guard equipment. The unit supply officer should be able to assist in finding the current prices and ordering the equipment.

2. Table 1, section E of MCO P10520.3B is used to determine which type of organizational color a unit rates.



MARINE CORPS DRILL AND CEREMONIES MANUAL

PART I: DRILL

CHAPTER 8

SQUAD DRILL

	<u>PARAGRAPH</u>	<u>PAGE</u>
GENERAL . . . . .	8000	8-3
TO FORM THE SQUAD . . . . .	8001	8-4
TO DISMISS THE SQUAD . . . . .	8002	8-6
TO COUNT OFF . . . . .	8003	8-6
TO ALIGN THE SQUAD . . . . .	8004	8-6
TO OBTAIN CLOSE INTERVAL FROM NORMAL INTERVAL IN LINE . . . .	8005	8-9
TO OBTAIN NORMAL INTERVAL FROM CLOSE INTERVAL IN LINE . . . .	8006	8-9
TO OBTAIN DOUBLE ARM INTERVAL IN LINE . . . . .	8007	8-9
TO OBTAIN NORMAL INTERVAL FROM DOUBLE ARM INTERVAL IN LINE .	8008	8-10
TO FORM A COLUMN FROM IN LINE AND REFORM TO A LINE . . . . .	8009	8-10
TO MARCH IN THE OBLIQUE . . . . .	8010	8-11
TO MARCH TO THE REAR . . . . .	8011	8-12
TO MARCH TO THE FLANK . . . . .	8012	8-13
TO CHANGE DIRECTION OF A COLUMN . . . . .	8013	8-13
TO FORM A COLUMN OF TWOS FROM A SINGLE FILE . . . . .	8014	8-14
TO FORM A SINGLE FILE FROM A COLUMN OF TWOS . . . . .	8015	8-15
TO STACK ARMS . . . . .	8016	8-16
TO TAKE ARMS . . . . .	8017	8-18

FIGURE

8-1	SQUAD FORMATIONS . . . . .	8-3
8-2	SIZING SQUADS . . . . .	8-4
8-3	DRESS RIGHT DRESS . . . . .	8-7
8-4	AT CLOSE INTERVAL DRESS RIGHT DRESS . . . . .	8-8

	<u>PAGE</u>
8-5	DRESS LEFT . . . . . 8-8
8-6	MARCHING TO RIGHT OBLIQUE . . . . . 8-11
8-7	FORMING COLUMN OF TWOS FROM SINGLE FILE . . . . . 8-14
8-8	FORMING SINGLE FILE FROM COLUMN OF TWOS . . . . . 8-15
8-9	POSITIONS OF STACKMEN AND INDIVIDUALS TO THE RIGHT AND LEFT AT THE END OF THE FIRST STEP IN STACK ARMS . . . . . 8-17
8-10	INSERTING RIFLES INTO THE STACKMEN'S FLING LOOP . . . . . 8-17
8-11	FINAL POSITION OF STACK ARMS . . . . . 8-18

PART I: DRILL

CHAPTER 8

SQUAD DRILL

8000. GENERAL

1. A squad is a group of individuals formed for the purpose of instruction, discipline, control, and order.

2. Members of the squad take positions, move, and execute the manual of arms as stated in this Manual. All individuals execute the movements at the same time. Squads may drill as squads or as part of a platoon or larger formation.

3. Squads are kept intact when practicable. The normal formation for a squad is a single rank (squad in line) or single file (squad in column). (See figure 8-1.) This permits variation in the number of individuals composing the squad. The first formation is always in line. Column formation may be taken from line formation. A squad, not at drill, may be marched in column of twos by forming in two ranks.

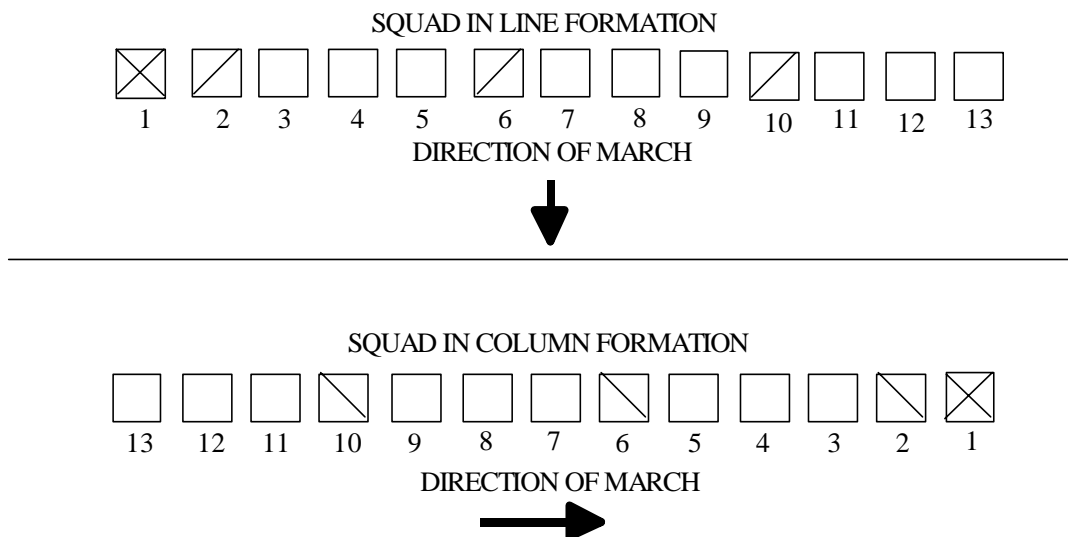

Figure 8-1.--Squad Formations.

4. The squad marches in line for minor changes of position only.

5. When the Squad is Armed with Rifles

a. The command **"Right (Left) Shoulder, ARMS;" "Port, ARMS;"** or **"Sling, ARMS"** is given before commanding the squad to move, except for short distances. When moving short distances the command **"Trail, ARMS"** may be given or it may be executed automatically.

b. At the command **"Squad, HALT"** remain at the position of right shoulder (left shoulder, port or sling) arms until **"Order, ARMS"** or some other manual command is given.

6. In this Chapter the term "unit leader," (e.g., "The unit leader then checks the alignment) means the individual drilling the squad. He/she may be the squad leader, other noncommissioned officer, or squad member drilling the squad for an inspection or evaluation. If the unit leader is the squad leader, then the number two Marine (see figure 8-1) executes the movements of the squad leader. The unit leader must maintain proper distance (3 paces) from the squad and remain centered on the squad during all drill movements.

a. If the squad executes a right step, the unit leader, who is facing the squad, would execute a left step in cadence with the squad to maintain proper position. For a right step the unit leader would execute a left step.

b. If the squad executes a back step, the unit leader would execute a half step, in cadence with the squad to maintain proper position.

c. Movements of the unit leader during other squad movements are explained in the paragraph describing the movement.

#### 8001. TO FORM THE SQUAD

1. Members of the squad normally form as indicated in figure 8-1. (e.g., maintain fire team/section integrity). However, for parades and ceremonies where appearance is more important, the squads should be sized. To size the squad the tallest member takes position 2 in figure 8-1 with the shortest squad member in position 13. The squad leader, regardless of height, always forms as the squad leader, in position one of figure 8-2.



a. Squad Formed with Unit Integrity.

Figure 8-2.—Squads Sizing



b. Squad Sized.

Figure 8-2.--Sizing Squads--Continued.

2. To form at normal interval, the command is "**FALL IN.**"
3. The squad forms in line on the left of the squad leader. Each member of the squad, except the individual on the left flank, raises their left arm shoulder high in line with their body. Fingers are extended and joined, palm down thumb extended along the forefinger. Each individual except the squad leader turns their head and looks to the right. To obtain a normal interval, everyone places himself in line so their right shoulder touches the fingertips of the person on their right. As soon as each individual is in line with the person on their right, and the person on their left has obtained normal interval, they assume the position of attention smartly but quietly.
4. To form at close interval, the command is "**At Close Interval, FALL IN.**"
5. The squad forms in line on the left of the squad leader. Each member of the squad, except the individual on the left flank, places their left hand on their hip, elbow in line with the body. They rest the heel of the palm on the hip with fingers extended and joined and pointing down. Everyone except the squad leader turns their head and looks to the right. To obtain close interval, they place themselves in line so their right arm touches the elbow of the person on their right. As soon as each individual is in line with the person on their right, and the person on their left has obtained close interval, they assume the position of attention smartly but quietly.
6. If the squad is armed, members fall in with weapons at the position of order arms. Weapons are inspected at once unless a report is to be taken. If so they will be inspected immediately following the report with the following commands: "**Inspection, ARMS;**" "**Port, ARMS;**" and "**Order, ARMS.**"

8002. TO DISMISS THE SQUAD

1. The squad is dismissed only from a line with individuals at attention.
2. Armed troops are dismissed with the commands "**Inspection, ARMS;**" "**Port, ARMS;**" and "**DISMISSED.**"
3. Unarmed troops are dismissed with the command "**DISMISSED.**"

8003. TO COUNT OFF

1. In line, the command is "**Count, OFF.**" At the command "**OFF,**" everyone except the squad leader, turn their heads 90 degrees over the shoulder and look to the right. The squad leaders shout ONE. The person in the file to the left of the squad leaders turns his/her head smartly back to the front and at the same time shouts TWO. After the person to their right has shouted their number, each subsequent person to the left turns his/her head back to the front and at the same time shouts the next higher number. Numbers are counted off in quick time cadence.
2. In column, on the command "**From Front to Rear, Count, OFF,**" the squad leader smartly turns his/her head to the right 90 degrees over the shoulder and shouts ONE as the head is turned back to the front. Each subsequent rank, having seen the person's head in front of them return to the front, turns his/her head to the right and shouts the next higher number as the head is turned smartly back to the front. This is carried on in sequence at quick time cadence.

8004. TO ALIGN THE SQUAD

1. The purpose of these movements is to dress the alignment of the squad. They may be executed when the squad is halted at attention in line. The commands are "**Dress Right (Left), DRESS**" or "**At Close Interval, Dress Right (Left), DRESS.**" These commands are given only when the squad is at approximately the same interval as the interval at which the dress is commanded.

2. Dress Right Dress

a. On the command "**Dress Right, DRESS,**" everyone except the squad leader, smartly turn their heads to the right, 90 degrees over the shoulder look, and align themselves. At the same time, everyone except the individual on the left flank, provide interval by smartly raising their left arm to shoulder height and in line with their body. Fingers are extended and joined, thumb along the forefinger, palm down. (See figure 8-3.)

b. As the base of the movement, the squad leader keeps his/her head and eyes to the front. All other members of the squad position themselves by short steps until their right shoulders lightly touch the fingertips of the person on their right.

c. The unit leader, on his/her own command of execution "**DRESS,**" faces half left, as in marching, and proceeds by the most direct route to a position on line with and one pace to the right of the individual on the right flank. At this position, the unit leader executes a halt in the oblique facing the rear of the formation, and then executes a right face, facing down the line of the squad. The unit leader aligns the squad by commanding those individuals in advance or rear of

the line to move forward or backward until in line. These individuals are designated by name or number. For example: **"Jones, FORWARD;"** or **"Number Three, BACKWARD."** Those individuals will move until receiving the command **"STEADY."** The unit leader may execute a series of short side steps to the right or left in order to identify an individual. However, prior to commanding the identified individual to move, the unit leader will be on line with the rank. After verifying the alignment of the squad, the unit leader faces to the right in marching, marches straight to a point 3 paces beyond the squad, halts, faces to the left, and commands **"Ready, FRONT."** Immediately after commanding **"FRONT,"** the unit leader marches by the most direct route back to a post 3 paces front and centered on the squad.

d. On the command **"Ready, FRONT,"** all members of the squad who raised their left arm and turned their head to the right, will smartly but quietly lower their arm to their side and at the same time turn their head back to the front, assuming the position of attention.

e. When aligning a squad of well-drilled troops or when there is insufficient time to verify alignment, the unit leader may command **"Ready, FRONT"** from his/her normal position (3 paces front and centered), without having verified alignment.



Figure 8-3.--Dress Right Dress.

3. At Close Interval Dress Right Dress. This movement is executed in the same manner as dress right dress except for the following:

a. On the command **"At Close Interval, Dress Right, DRESS,"** those individuals providing interval will do so by placing the heel of their left hand on their hip with the elbow in line with their body. Fingers are extended and joined and pointing down. Members gaining interval will move by short steps until their right arm is touching the left elbow of the individual to their left. (See figure 8-4.)



Figure 8-4.--At Close Interval Dress Right Dress.

4. Dress Left Dress and at Close Interval Dress Left Dress. These movements are similar to dress right dress and at close interval dress right dress except that alignment is made toward the left. The individual on the left flank of the rank is the base of the movement and stands fast. On the command "**Dress Left, DRESS**" or "**At Close Interval, Dress Left, DRESS,**" everyone except the individual on the left flank smartly turn their heads to the left, look, and align themselves. At the same time they will smartly raise their left arm or elbow to provide interval (the left arm is used for both dress right and dress left). The unit leader will verify alignment of the squad from its left flank. (See figure 8-5.)



Figure 8-5.--Dress Left.



5. To align in column, the command is "**COVER.**" At this command, members move as necessary to place themselves directly behind the person in front of them, still maintaining a 40-inch distance.

8005. TO OBTAIN CLOSE INTERVAL FROM NORMAL INTERVAL IN LINE

1. The purpose of this movement is to close the interval between individuals of a squad in line to 4 inches. It may be executed when the squad is halted at attention and in line at normal interval. The command is "**Close, MARCH.**"

2. The squad leader is the base of this movement. On the command of execution "**MARCH,**" the squad leader stands fast and places his/her left hand on his/her hip, as if dressing at close interval, to provide interval for the individuals to the left. At the same time, all other members of the squad face to the right as in marching, march toward the right flank until approximately 4 inches from the person in front of them, halt, and face to the left. They then execute at close interval dress right dress. After aligning and without command, they will smartly lower their left hands and turn their heads to the front as soon as the individual to their left has touched their elbow with his/her right arm and stopped moving.

3. On his/her command of execution, the unit leader steps to the left in marching. He/she marches parallel to the squad maintaining a distance of 3 paces from the squad. When approximately on the center of the squad at close interval the unit leader halts and faces the squad. He/she then adjusts to the center of the squad by taking small steps left, right, forward or back.

8006. TO OBTAIN NORMAL INTERVAL FROM CLOSE INTERVAL IN LINE

1. The purpose of this movement is to extend the interval between individuals of a squad in line to one arm length. It may be executed when the squad is halted at attention and in line at close interval. The command is "**Extend, MARCH.**"

2. The squad leader is the base of this movement. On the command of execution "**MARCH,**" the squad leader stands fast and raises his/her left arm to shoulder height to provide interval for the person on the left. At the same time, all other members of the squad face to the left as in marching, march toward the left flank until they have opened approximately a 30-inch distance from the person behind them, halt, and face to the right. They then execute dress right dress. After aligning and without command, they will smartly, and quietly, lower their left arms and turn their heads to the front as soon as the individual to their left has touched their finger tips with his/her right shoulder and has stopped moving.

3. On his/her command of execution, the unit leader steps to the right in marching. He/she marches parallel to the squad maintaining a distance of 3 paces from the squad. When approximately on the center of the squad at normal interval the unit leader halts and faces the squad. He/she then adjusts to the center of the squad by taking small steps left, right, forward or back.

8007. TO OBTAIN DOUBLE ARM INTERVAL IN LINE

1. The purpose of this movement is to extend the interval between the individuals of a squad to a double arm distance. It may be executed when the squad is halted

at attention and in line at normal or close interval. If armed, rifles must be at sling arms. The command is **"Take Interval to the Left, MARCH."**

2. The squad leader is the base of this movement. On the command of execution **"MARCH,"** the squad leader stands fast and raises his/her left arm to shoulder height, to provide interval for the persons on the left. At the same time, all other members of the squad face to the left as in marching, march toward the left flank until they have opened approximately a 70-inch distance from the person behind them, halt, and face to the right. They then smartly turn their heads to the right and raise both arms to shoulder height. Individuals on the left flank will only raise their right arm. After aligning and without command, they will smartly, and quietly, lower their right arms and turn their heads to the front as soon as they have proper interval. They will lower their left arms when they feel the individual to their left lower his/her right arm.

3. On his/her command of execution, the unit leader steps to the right in marching. He/she marches parallel to the squad maintaining a distance of 3 paces from the squad. When approximately on the center of the squad at double arms interval the unit leader halts and faces the squad. He/she then adjusts to the center of the squad by taking small steps left, right, forward or back.

8008. TO OBTAIN NORMAL INTERVAL FROM DOUBLE ARM INTERVAL IN LINE

1. The purpose of this movement is to decrease the interval between individuals of a squad in line from double arm to normal interval. It can only be executed when the squad is halted at attention and in line at a double-arm interval. The command is **"Assemble to the Right, MARCH."** On the command of execution, the interval is reduced in a manner similar to close march; except that individuals halt approximately 30 inches from each other, face and execute the appropriate dress movement to obtain normal interval.

2. On his/her command of execution, the unit leader steps to the left in marching. He/she marches parallel to the squad maintaining a distance of 3 paces from the squad. When approximately on the center of the squad at normal interval the unit leader halts and faces the squad. He/she then adjusts to the center of the squad by taking small steps left, right, forward or back.

8009. TO FORM A COLUMN FROM IN LINE AND REFORM TO A LINE

1. When halted in line at normal interval and at the order if armed with rifles, the command to form a column is **"Right, FACE."** All members of the squad simultaneously face to the right, thereby forming column. The squad leader may then command **"Right (Left) Shoulder, ARMS;" "Port, ARMS;" "Sling, ARMS;"** or **"Forward (Column {Half} Right/Left), MARCH"** to cause the squad to march in column.

NOTE: The squad becomes inverted if faced to the left, this should be done only for short movements. When it is desired to form a column facing to the left, the squad should first form column by facing to the right, then execute necessary successive column movements until the column is faced in the desired direction.

2. When in line at close interval, the squad is first extended to normal interval (see paragraph 8006), then forms column by facing to the right as described above.

3. When in column at a halt and at the order, to form a line, the command is **"Left, FACE."**

#### 8010. TO MARCH IN THE OBLIQUE

1. The purpose of this movement is to shift the line of march to the right or left and then resume marching in the original direction. It may be executed from any formation that is marching at quick time cadence. The command is **"Right (Left) Oblique, MARCH."** The word oblique is pronounced to rhyme with strike. The command of execution is given as the foot in the direction of the turn strikes the deck. The command to resume the original direction of march is **"Forward, MARCH."** The command of execution is given as the foot toward the original front strikes the deck.

2. To teach the squad to march to the oblique, the unit leader aligns the unit and has members face half right (left). The unit leader then explains that these positions are maintained when marching to the oblique. This is achieved by individuals keeping their shoulders parallel to the persons in front and/or adjacent to them. The squad leader is the base of the movement, and must maintain a steady line of march keeping his/her shoulders blocked perpendicular to the direction of march.

3. At the command **"Right Oblique, MARCH"** the command of execution is given as the right foot strikes the deck. Everyone then takes one more 30-inch step to the front with the left foot and pivots 45 degrees to the right on the ball of the left foot. Stepping out of the pivot with a 30-inch step, the entire squad marches to the right oblique until given another command. (See figure 8-6.) For the squad to resume marching in the original direction, the command is **"Forward, MARCH"** in this case the command of execution will be given as the left foot strikes the deck. Everyone then takes one more step in the oblique direction; pivots back to the original front and continue to march. To march to the left oblique, substitute left for right and right for left in the above sequence.

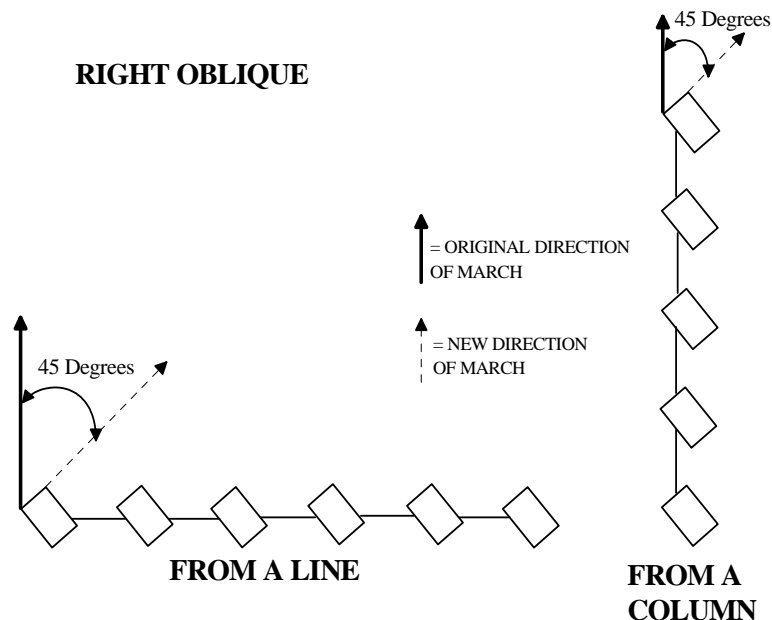

Figure 8-6.--Marching to Right Oblique.

4. To halt the squad facing in the original direction of march the command is **"Squad, HALT."** The command of execution **"HALT"** is given on the left foot when marching to the right oblique and on the right foot when marching to the left oblique. At the command **"HALT,"** everyone takes one more step in the oblique direction, pivots to the original front on the toe of the right (left) foot, and places the left (right) foot beside the other at the position of attention.
5. To temporarily halt the squad in the oblique direction, in order to correct errors, the command is **"In Place, HALT."** The command of execution **"HALT"** may be given as either foot strikes the deck. At the command of execution **"HALT,"** the squad halts in two counts as in quick time and remains facing in the oblique direction. The only command that can be given after halting in place is **"Resume, MARCH."** At that command, the movement continues marching in the oblique direction.
6. When given half step or mark time while marching in the oblique, the only commands that may be given are **"Resume, MARCH"** to continue marching with a 30-inch step in the oblique; or **"In Place, HALT"** to halt in the oblique in order to correct errors.

#### 8011. TO MARCH TO THE REAR

1. The purpose of this movement is to march the squad to the rear for a short distance. It may be executed when halted or marching forward at quick time or double time. The command is **"To the Rear, MARCH."** The command of execution will be given as the right foot strikes the deck.
2. When halted, on the command of execution **"MARCH,"** everyone takes one 15-inch step to the front with the left foot and then pivots 180 degrees toward the right on the balls of both feet. Stepping out of the pivot with a 30-inch step, the entire squad marches to the rear. For the squad to resume marching in the original direction the command **"To the Rear, MARCH"** is given again. No other command may be given when marching to the rear until the unit has resumed marching to the original front.
3. When marching at quick time, on the command of execution **"MARCH,"** everyone takes one more 15 inch step to the front with the left foot and then pivots 180 degrees toward the right on the balls of both feet. Stepping out of the pivot with a 30-inch step, the entire squad marches to the rear. For the squad to resume marching in the original direction, the command **"To the Rear, MARCH"** is given again. No other command may be given when marching to the rear until the unit has resumed marching to the original front.
4. When marching at double time, on the command of execution **"MARCH,"** everyone takes two more 36-inch steps to the front and then four, 6-inch vertical steps in place at double time cadence. On the first and third steps in place, everyone pivots 180 degrees to the right. After the fourth step in place, and for the fifth step, they step off with a 36-inch step in the new direction. For the squad to resume marching in the original direction, the command **"To the Rear, MARCH"** is given again. No other command may be given when marching to the rear until the unit has resumed marching to the original front.

8012. TO MARCH TO THE FLANK

1. The purpose of this movement is to march the squad to the right or left flank for a short distance. It may be executed from any formation that is marching at quick time or double time cadence. The command is **"By the Right (Left) Flank, MARCH."** The command of execution is given as the foot in the direction of the turn strikes the deck.
2. To march to the right flank, when marching at quick time, the command is **"By the Right Flank, MARCH."** On the command of execution **"MARCH,"** everyone takes one more 30-inch step to the front with the left foot and then pivots 90 degrees to the right on the ball of the left foot. Stepping out of the pivot with a 30-inch step, the entire squad marches in line to the right flank. The unit leader executes the flanking movement with the squad maintaining his/her distance from the squad. For the squad to resume marching in the original direction, the command is **"By the Left Flank, MARCH."** To march to the left flank, substitute left for right and right for left in the above sequence. No other command may be given when marching to the flank until the unit has resumed marching to the original front.
3. When marching at double time, on the command of execution **"MARCH,"** everyone takes two more 36-inch steps to the front and then two, 6-inch vertical steps in place at double time cadence. While stepping in place, everyone turns 90 degrees toward the direction commanded and then steps off with a 36-inch step in the new direction. No other command may be given when marching to the flank until the unit has resumed marching to the original front.

8013. TO CHANGE DIRECTION OF A COLUMN

1. The purpose of this movement is to change the direction of march of a column. It may be executed when the squad is halted or marching in column. The command is **"Column Right (Column Left, Column Half Right, or Column Half Left), MARCH."** The squad leader establishes the pivot for the movement.
2. When marching, the commands of execution are given on the foot in the direction of the turn. On the command of execution **"MARCH,"** the squad leader takes one more 30-inch step to the front and then pivots 90 degrees to the right (left) on the ball of the left (right) foot. He/she then takes a 30-inch step in the new direction. The remaining members of the squad continue to march to the point where the squad leader pivoted. They would then pivot 90 degrees in the new direction of march.
3. When halted, at the command of execution **"MARCH,"** the squad leader faces to the right (left) as in marching and takes one 30-inch step in the new direction with the right (left) foot. The remaining members of the squad step off to the front as in forward march. The remainder of the movement is executed the same as in marching.
4. Column half right (left) is executed as described above except that the pivot is 45 degrees to the right (left).
5. During column movements, the unit leader executes the movement with the squad, maintaining proper distance from the squad.
6. For slight changes of direction, the command is **"INCLINE TO THE RIGHT (LEFT)."** At that command, the squad leader changes direction slightly as commanded. This is not a precision movement and is executed only while marching.

8014. TO A FORM COLUMN OF TWOS FROM SINGLE FILE

1. When the squad is halted in column, the command is **"Column of Twos to the Left (Right), MARCH."**
2. If squad members do not already know whether they are an odd or even number, the squad must be given count off before the above command is given.
3. On **"MARCH,"** the squad leader stands fast. Even-numbered squad members face half left (right) in marching, take two steps, face half right (left) in marching, and march forward to halt beside and at normal interval from the odd-numbered squad member who was originally in front of them. Odd numbered members, except the squad leader, march forward and halt as they attain a 40-inch distance from the odd-numbered member in front of them. All members required to move do so at the same time. (See figure 8-7.)

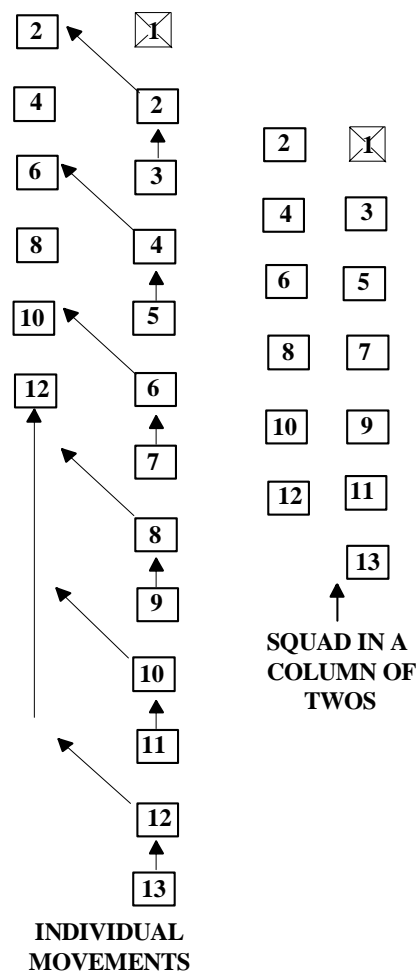

Figure 8-7.--Forming Column of Twos from Single File.

8015. TO FORM A SINGLE FILE FROM A COLUMN OF TWOS

1. When the squad is halted in column of twos, the command is **"Column of Files from the Right (Left), MARCH."** It is important to note, in order to keep from inverting the squad, that:

a. If a column of twos was built TO the LEFT, then a column of files must be formed FROM the RIGHT.

b. If a column of twos was built TO the RIGHT, then a column of files must be formed FROM the LEFT.

2. At the command **"MARCH,"** number one and two members step off at the same time. Number 1 moves forward as number 2 steps half right in marching, moves 2 steps, faces half left in marching, and follows number 1 at a 40-inch distance. Remaining odd and even numbered members step off in pairs, execute the same movements as numbers one and two, and follow in file. (See figure 8-8.)

a. When teaching this movement the unit leader should, after the command of execution **"MARCH,"** begin calling a cadence of "and, STEP, and, STEP." For example, on the command of execution **"MARCH,"** the number one and two squad members step off. On the first "and, STEP" the number three and four squad members step off. On the second "and, STEP" the number five and six squad members step off, etc. This cadence helps the squad member's step off at the correct time and keeps the squad in step.

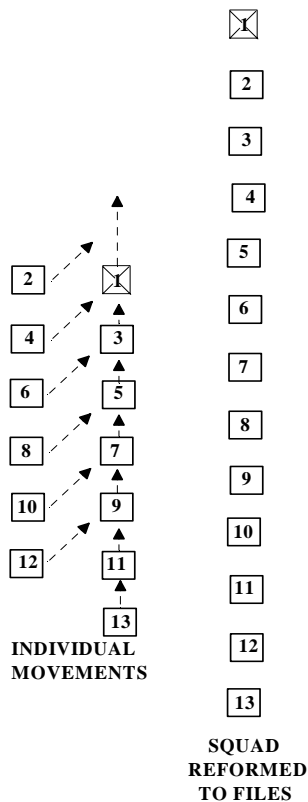

Figure 8-8.--Forming Single File from Column of Twos.

8016. TO STACK ARMS

1. The purpose of this movement is to temporarily relieve the squad of its weapons. It may be executed when the squad is halted in line. The command is **"Stack, ARMS;"** however, this command must be preceded by preliminary commands in order to prepare the squad to stack arms. Assuming the squad is halted in line at normal interval, the sequence of commands will be: **"Count, OFF,"** **"NUMBERS 3, 7 AND 11 ARE STACKMEN;"** **"Prepare, SLINGS;"** and **"Stack, ARMS."**

2. On the command **"Count, OFF,"** the squad counts off as prescribed in paragraph 8003.

3. Stackmen are designated by file number. The unit leader commands **"NUMBERS 3, 7 AND 11 ARE STACKMEN."** In other words the number 3, 7, and 11 persons in each squad are designated as stackmen. Additional stackmen may be designated if the squad has enough additional rifles to warrant it. The numbers 3, 7, and 11 are used to preserve fire team integrity for each weapons stack. If the squad is not divided into fire teams, numbers 2, 5, 8, and 11 may be designated stackmen. This reduces the number of extra weapons that must be added to the stacks.

4. On the command **"Prepare, SLINGS,"** the designated stackmen place the butt of their rifles on their right hip and cradle them in the crook of their right arm. They then adjust their slings to form a 4-inch loop next to upper sling swivel. As soon as they have prepared the loop, they return to order arms.

5. On the command **"Stack, ARMS,"** the designated stackmen place their weapons directly in front of and centered on their bodies with the sights to the rear. The heel of the rifle butt is placed on the ground on line with the toes of their shoes. Each stackman grasps the rifle at the upper portion of the handguard with the left hand, keeping the rifle vertical. The first two fingers of the left hand hold the inner part of the loop against the rifle. The stackman reaches across the front of the rifle with the right hand, grasps the outer part of the loop and holds it open for insertion of the rifles. (See figure 8-9.) At the same time, the individuals to the left and right of the stackmen perform the following movements simultaneously:

a. The individuals on the stackmen's right raise and center their weapons by bringing their right wrist to shoulder height and centered on their bodies, magazine well facing the front. They then grasp the handguards (midway) with the left hand, sling included in the grasp, release the right hand, and re-grasp the weapon at the small of the stock. Arms are then lowered to a dead hang, so that the weapons are held in a horizontal position with the muzzles to the left and magazine wells still to the front. (See figure 8-9.)

b. The individuals on the stackmen's left raise and center their weapons by bringing their right wrists to shoulder height and centered on their bodies, magazine wells face the front. They then grasp their weapons at the small of the stock with their left hands, sling included in the grasp, release their right hands and re-grasp the handguards (midway). Arms are lowered to a dead hang, so that the weapons are held in a horizontal position with the muzzles to the right and the magazine wells still to the front. (See figure 8-9.)





Figure 8-9.--Positions of Stackmen and Individuals to the Right and Left at the End of the First Step in Stack Arms.

c. As soon as the stackmen have placed their rifles in position, both the individuals to the right and left move their feet nearest the stackmen, 18 inches in the oblique toward the stackmen. The individuals on the stackmen's left insert the muzzles of their rifles into the loops to a point approximately halfway between the compensator and the front sight. They hold their weapons in this position until the individuals on the stackmen's right insert the muzzles of their rifles in a similar manner, but above the other rifle in each loop. (See figure 8-10.)



Figure 8-10.--Inserting Rifles Into the Stackmen's Sling Loop.

d. The butts of the rifles inserted into the loops are swung outward and down to the ground until the stacks are tight with the rifle butts on line and approximately 2 feet forward of the stackmen's rifle. The rifles rest on the side of the butts with the pistol grips pointing inboard toward each other. As each stack is completed, all three individuals stand up at the same time and resume the position of attention. (See figure 8-11.)



Figure 8-11.--Final Position of Stack Arms.

e. Extra rifles are passed to the nearest stacks on the right. Individuals holding extra rifles grasp the barrels of their rifle raise them vertically and then extend their right arms horizontally to the right front. The persons to the right grasp the weapons at the handguard, center them on their bodies grasp the barrels with their right hands and extend their right arms horizontally to the right front. This action is repeated until the rifles reach the stackmen. The stackmen lean the rifles against the center of the stacks in such a manner as to prevent them from falling or knocking the stacks over. The squad leader passes his/her rifle to the first stack on his/her left by raising the weapon with the right hand to a position centered on the body as in the first count of present arms from order arms figure 3-15b. He/she then grasps the weapon with the left hand at the handguards; sling included in the grasp, and passes the weapon to the left by extending the left arm horizontally to the left front. The individual to the squad leader's left then grasps the rifle at the barrel with the right hand, centers it on the body grasps the handguards with the left hand and passes it to the stackman.

#### 8017. TO TAKE ARMS

1. The purpose of this movement is to recover arms that have been stacked. It may be executed only when the squad has fallen back in on the weapons stacks. The command is **"Take, ARMS."**

2. On the command of execution **"ARMS,"** if there are extra arms they are passed back in a reverse manner of the way they were passed to the stacks. When extra arms have been passed back, or if there were no extra arms, the stackmen grasp their rifles and hold the loops in the same manner as was done for stacking arms. The individuals to the left and right step in the oblique reach down and re-grasp their weapons and bring them to a horizontal position. The individual on the right removes his/her rifle first and resumes order arms or unsling arms. The individual on the left removes his/her weapon and resumes order arms or unsling arms. The stackman cradles his/her weapon and adjusts the sling and sling keeper to its original position and then resumes the order or unsling arms position.

MARINE CORPS DRILL AND CEREMONIES MANUAL

PART I: DRILL

CHAPTER 9

PLATOON DRILL

	<u>PARAGRAPH</u>	<u>PAGE</u>
GENERAL . . . . .	9000	9-3
FORMATIONS . . . . .	9001	9-3
POSTS OF INDIVIDUALS . . . . .	9002	9-5
RULES FOR THE GUIDE . . . . .	9003	9-5
TO FORM THE PLATOON . . . . .	9004	9-6
TO DISMISS THE PLATOON . . . . .	9005	9-7
TO COUNT OFF . . . . .	9006	9-8
TO FORM COLUMN FROM LINE . . . . .	9007	9-8
TO FORM LINE FROM COLUMN . . . . .	9008	9-8
TO ALIGN THE PLATOON . . . . .	9009	9-9
TO OBTAIN CLOSE INTERVAL FROM NORMAL INTERVAL IN LINE . . . . .	9010	9-11
TO OBTAIN NORMAL INTERVAL FROM CLOSE INTERVAL IN LINE . . . . .	9011	9-12
TO OBTAIN DOUBLE ARM INTERVAL IN LINE . . . . .	9012	9-12
TO OBTAIN NORMAL INTERVAL FROM DOUBLE ARM INTERVAL . . . . .	9013	9-13
TO OBTAIN CLOSE INTERVAL IN COLUMN . . . . .	9014	9-13
TO EXTEND TO NORMAL INTERVAL IN COLUMN . . . . .	9015	9-15
TO OPEN RANKS . . . . .	9016	9-15
TO CLOSE RANKS . . . . .	9017	9-16
TO STACK ARMS . . . . .	9018	9-17
TO TAKE ARMS . . . . .	9019	9-18
TO FORM FOR PHYSICAL DRILL . . . . .	9020	9-19
TO CHANGE THE DIRECTION OF A COLUMN . . . . .	9021	9-20
TO MARCH TO THE FLANK . . . . .	9022	9-21

MARINE CORPS DRILL AND CEREMONIES MANUAL

	<u>PARAGRAPH</u>	<u>PAGE</u>
TO MARCH IN THE OBLIQUE . . . . .	9023	9-23
TO MARCH TO THE REAR . . . . .	9024	9-24
TO FORM A COLUMN OF TWOS OR FILES AND REFORM . . . . .	9025	9-25

FIGURE

9-1	PLATOON IN LINE AT NORMAL INTERVAL . . . . .	9-4
9-2	PLATOON IN COLUMN AT NORMAL INTERVAL . . . . .	9-4
9-3	MOVEMENTS OF THE PLATOON COMMANDER WHEN ALIGNING THE PLATOON . . . . .	9-10
9-4	CLOSE MARCH (WHILE MARCHING), RIGHT SQUAD BASE . . . . .	9-14
9-5	EXECUTING COLUMN RIGHT (LEFT) . . . . .	9-21
9-6	RIGHT (LEFT) FLANK . . . . .	9-22
9-7	MARCHING TO RIGHT OBLIQUE . . . . .	9-23
9-8	COLUMN OF TWOS FROM COLUMN OF THREES AND REFORM . . . . .	9-26
9-9	COLUMN OF TWOS FROM COLUMN OF FOURS AND REFORM . . . . .	9-28
9-10	COLUMN OF FILES FROM COLUMN OF THREES AND REFORM . . . . .	9-30

MARINE CORPS DRILL AND CEREMONIES MANUAL

PART I: DRILL

CHAPTER 9

PLATOON DRILL

9000. GENERAL

1. The first phase of drill has been explained in earlier chapters of this Manual. This Chapter discusses the next phase, platoon drill. In platoon drill, the squad is merged with other squads into a platoon.
2. A platoon consists of a platoon headquarters and two or more squads or sections. Platoon headquarters consists at a minimum of a platoon commander, a platoon sergeant and a platoon guide. One or more assistants may be designated.
3. A section normally forms and drills as part of a platoon. In this Manual, the instructions given for the squad or platoon also apply to a section. A section, not subdivided into squads, forms and drills as a squad. A section that is divided into two or more squads forms and drills as a platoon.
4. Squads in a platoon are numbered from front to rear in column (when facing the front of the column) and from right to left in line.
5. The platoon forms in two or more ranks with a 40-inch distance between ranks. Movements in this Section are described for columns of threes or fours and may be executed by either formation.
6. The platoon changes interval while in line and counts off in the same manner as the squad. Squad leaders are the base for these movements. The guide moves to the right when interval is taken to the left, and does not count off.
7. In platoon drill, if all members of the platoon are to execute a movement simultaneously, the movement is executed on the command of the platoon commander. In this case, squad leaders do not repeat or give any commands. When squads of the platoon are to execute a movement in successive order, such as forming column of twos (files) and reforming into column (of threes, etc.), squad leaders give appropriate supplemental commands for the movement of their squads.
8. Unless specified for the platoon to be at close interval, all changes in formation should be executed with normal interval and distance between files and ranks.
9. The unit leader will march to the left and parallel to the platoon, from a position where he/she can best control the unit.
10. All commands given by the unit leader while the platoon is halted will be 6 paces in front of the unit and centered on the element.

9001. FORMATIONS

1. Column and line are the two formations for a platoon. (See figures 9-1 and 9-2.)

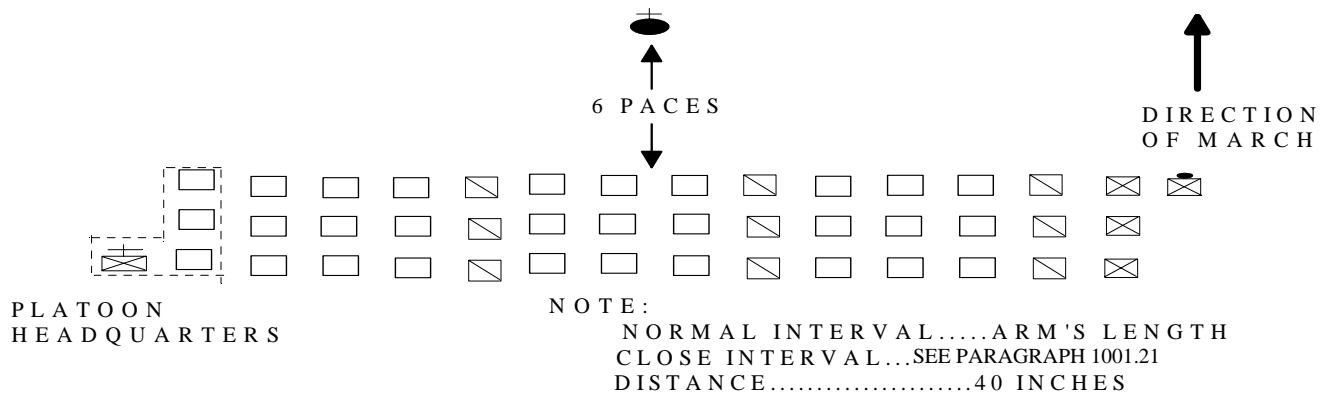

Figure 9-1.--Platoon in Line at Normal Interval.

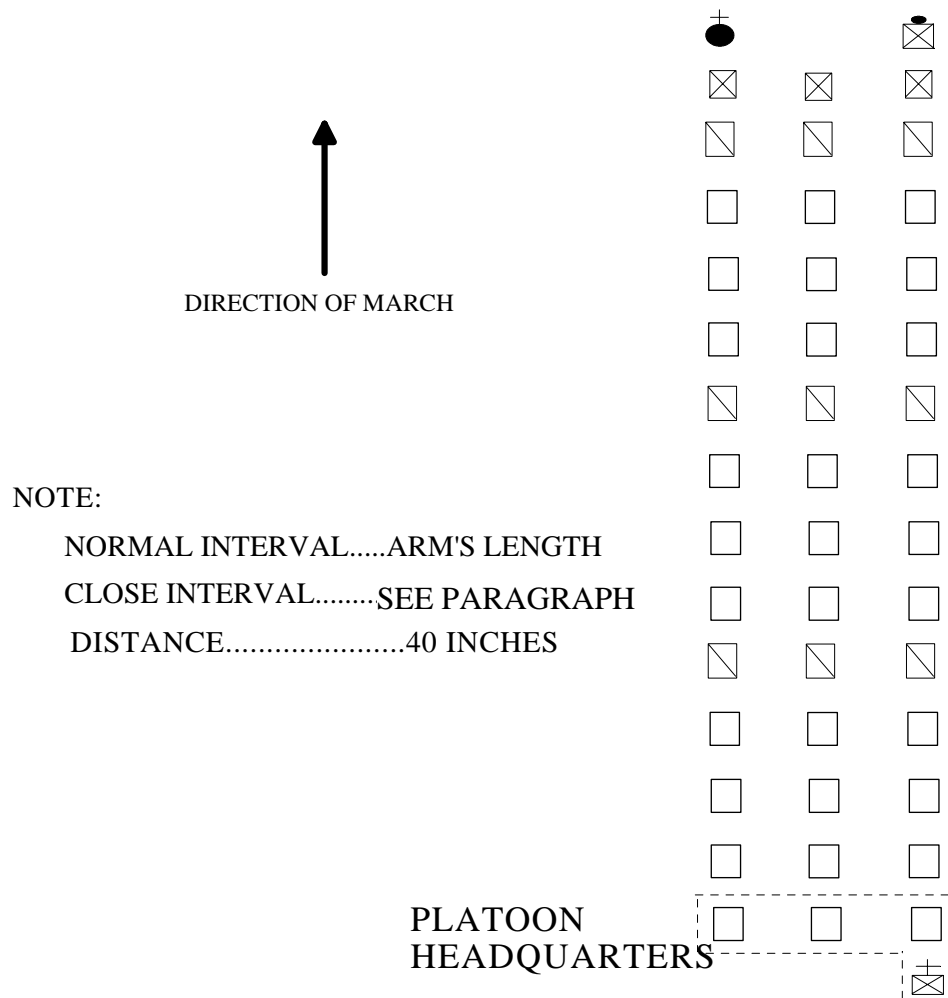

Figure 9-2.--Platoon in Column at Normal Interval.

2. The platoon normally forms in line with the squad leaders on the right of their squads and the guide on the right of the first squad leader. (See figure 9-1.) The platoon marches in line for short distances only. The platoon is normally marched in column with the squad leaders in front of their squads and the guide in front of the third (right) squad leader. (See figure 9-2.)

#### 9002. POSTS OF INDIVIDUALS

1. In line, the platoon commander's post is 6 paces in front of the center of the front rank of the platoon. (See figure 9-1.) In column, the platoon commander marches at the head of the left file of the platoon (see figure 9-2), unless drilling the platoon, in which case he/she would maintain a position 6 paces from the platoon.

2. When the platoon commander is present, the platoon sergeant takes post to the left of the left member of the rear rank when the platoon is in line. When in column, the platoon sergeant follows the last member of the right file (squad). When the platoon commander is not present, the platoon sergeant takes the platoon commander's post and drills the platoon in the manner prescribed for the platoon commander.

3. The platoon guide takes post as stated in paragraph 9003.

4. Extra members may fall in on the left when the platoon is in line and in the rear when in column. If the squads are evenly filled, the first extra member falls in with the first squad, the second with the third (fourth) squad and then remaining squads. The platoon sergeant will reposition when necessary so as to remain the last person in the last rank.

5. In this Chapter the term "platoon commander," e.g., the platoon commander then checks the alignment, means the individual drilling the platoon. He/she may be the platoon leader, platoon sergeant, or platoon member drilling the platoon for an inspection or evaluation. Except when marching at the head of a platoon column, the platoon commander must maintain proper distance (6 paces) from the platoon and remain centered on the platoon during all drill movements.

a. If the platoon were executing a right step, the platoon commander, who is facing the platoon, would execute a left step in cadence with the platoon in order to maintain proper position. For a left step the platoon commander would execute a right step.

b. If the platoon were executing a back step, the platoon commander would execute a half step, in cadence with the platoon in order to maintain proper position.

c. Movements of the platoon commander during other platoon movements are explained in the paragraph describing the movement.

#### 9003. RULES FOR THE GUIDE

1. Unless otherwise directed, guide is right and the platoon guide takes post on the right. In line, the guide is posted to the right of the squad leader of the first squad. In column, the guide is posted in front of the squad leader of the third or right squad.



2. In column, when it is desired to guide left or center, the command "**GUIDE LEFT**" is given. At this command, the guide and the platoon commander exchange positions. The guide crosses between the platoon commander and the platoon. To return the guide to normal position, "**GUIDE RIGHT**" is commanded. The guide and platoon commander return to their normal positions with the guide again passing between the platoon commander and the platoon. This movement may be made at a halt or while marching. The base squad or file is the one behind the guide.
3. The guide does not change position at the command "**Dress Left, DRESS.**"
4. When a platoon in line is given the command "**Right, FACE,**" the platoon guide executes right face with the platoon. The guide then faces to the right in marching, moves to a position in front of the right squad leader, halts, and executes left face. If a platoon in line is given "**Left, FACE,**" the guide executes left face with the platoon but does not change position within the platoon.
5. When a platoon in column is given the command "**Column of Files from the Left,**" the guide takes position in front of the left squad leader so as to remain at the head of the column.
6. When a platoon in column is given the command "**Column of Twos from the Left,**" the guide takes position in front of the second squad so as to remain at the head of the right file of the column. These movements are executed by facing left as in marching, moving to the appropriate position, halting, and facing right.
7. When reforming in a column of threes or fours from a column of files or twos, the guide takes post at his normal position when the movement is completed.
8. The guide sets the direction and cadence of the march. The leading member of each file is responsible for interval.
9. When a platoon is marching in column and the command "**By the Right (Left) Flank, MARCH**" or "**To the Rear, MARCH**" is given, the guide executes the movement with the platoon but does not change relative position except during specific movements of company drill. (See paragraph 10011 for an exception.)
10. The guide does not count off.

9004. TO FORM THE PLATOON

1. The platoon forms in line at normal interval and distance between files and ranks (see figure 9-1) on the command "**FALL IN.**" To form at close interval, the command is "**At Close Interval, FALL IN,**" in which case the platoon forms in line with normal distance between ranks, but with close interval between files. The platoon sergeant or platoon commander forms the platoon as described below.
2. Forming the Platoon by the Platoon Sergeant
  - a. The platoon sergeant takes post 3 paces in front of the point where the center of the platoon will be, faces that point, draws sword if so armed, and commands either "**FALL IN**" or "**At Close Interval, FALL IN.**" At this command, the guide takes post so that the first rank, when aligned on the guide will be centered on and 3 paces from the platoon sergeant. The squad leader of the first squad

falls in to the left of the guide and aligns at normal or close interval. Other squad leaders fall in directly behind the squad leader of the first squad with 40 inches distance between them. The members of the squads fall in and align on their squad leaders at normal or close interval as prescribed in squad drill, except that exact interval is measured only by the front rank. Individuals in the rear ranks gain their interval by covering the corresponding member of the rank in front of them. All personnel fall in at attention and, if armed with the rifle, at the position of order arms.

b. When a report is appropriate, after all personnel are formed, the platoon sergeant commands, "**REPORT.**" Remaining in position (at order arms if armed with the rifle), the squad leaders, in sequence from front to rear, salute and report, "All present" or "(Rank and Name) absent." If the troops are armed, the platoon sergeant commands, "**Inspection, ARMS;**" "**Port, ARMS;**" and "**Order, ARMS.**" The platoon sergeant then executes about face. (NOTE: If the platoon cannot be formed in regularly organized squads prior to forming the platoon, the platoon sergeant commands "**Inspection, ARMS;**" "**Port, ARMS;**" "**Right Shoulder, ARMS;**" and calls the roll. Each Marine answers "here," and goes to order arms as their name is called. The platoon sergeant then organizes the platoon into squads and faces the front. The manual of arms is omitted for personnel not armed with rifles.)

c. To receive the platoon, the platoon commander takes post 3 paces in front of the platoon sergeant (sword in scabbard if so armed), the platoon sergeant salutes and reports, "Sir (Ma'am), all present or accounted for" or "Sir (Ma'am), (number) absent." The platoon commander returns the salute and may discuss absentees and issue necessary instructions to the platoon sergeant. The platoon commander then commands the platoon sergeant, "**TAKE YOUR POST.**" The platoon sergeant marches by the most direct route to a post on the left of the rear rank. The platoon commander then draws sword, if so armed.

d. If the platoon commander does not receive the platoon, the platoon sergeant takes 3 paces forward, faces about and assumes the post and duties of the platoon commander.

### 3. Forming the Platoon by the Platoon Commander

a. When appropriate, the platoon may be formed by the platoon commander rather than the platoon sergeant. The procedures are the same except that the platoon commander takes post 6 paces in front of the point where the center of the platoon will be, faces that point, draws sword and commands "**FALL IN**" or "**At Close Interval, FALL IN.**"

b. The platoon forms on the platoon commander, the platoon sergeant falling in on the left of the rear rank with sword drawn, if so armed. The platoon commander then receives the report from the squad leaders and causes the platoon to execute inspection arms if the troops are armed.

### 9005. TO DISMISS THE PLATOON

1. The platoon is dismissed only from in line while at attention.
2. Armed troops are dismissed with the commands "**Inspection, ARMS;**" "**Port, ARMS;**" and "**DISMISSED.**"
3. Unarmed troops are dismissed with the command "**DISMISSED.**"

4. The platoon sergeant usually dismisses the platoon.

9006. COUNT OFF

1. The purpose of this movement is to designate the relative position in ranks of each member of the platoon. It may be executed when the platoon is halted at attention in line or column. When in line the command is **"Count, OFF;"** when in column the command is **"From Front to Rear, Count, OFF."**

2. In line, on the command **"Count, OFF,"** everyone except the guide and squad leaders turn their heads 90 degrees to the right and look to the right. The squad leaders shout ONE. The persons in the file to the left of the squad leaders turn their heads smartly back to the front and at the same time shout TWO. After the file to their right has shouted its number, each subsequent file to the left turn their heads back to the front and shouts the next higher number. Numbers are counted off in quick time cadence.

3. In column, on the command **"From Front to Rear, Count, OFF,"** the squad leaders smartly turn their heads to the right and shout ONE as they return their heads back to the front. Each subsequent rank, having seen the heads in front of them return to the front, turn their heads to the right and shout the next higher number as they bring their heads smartly back to the front. This is carried on in sequence at quick time cadence. The guide does not turn his/her head nor count off. The platoon commander gives the command from a position 6 paces in front and centered on the squad leaders.

9007. TO FORM COLUMN FROM LINE. The purpose of this movement is to change the formation from line to column. It may be executed only when halted at normal interval, at attention, and at order arms if armed with rifles. The command is **"Right, FACE."** On the command of execution **"FACE,"** all members of the platoon face to the right, thereby forming column. The guide moves to his/her position in front of the right squad leader. The platoon commander may then command any halted movement from his/her current position, (e.g., right/left shoulder, port, sling, arms; facing movements, right/left step; etc.) unless otherwise indicated in this Chapter. If the platoon is to march as part of a larger formation the platoon commander takes post in front of the left file and the guide in front of the right file. (See figure 9-2.) From this position the platoon commander would command **"Forward (Column Right {Left}), MARCH"** to cause the platoon to march in column. (NOTE: Since the platoon becomes inverted if faced to the left, this should only be done for short adjusting movements. To properly form column facing to the left, the platoon should first form column by facing to the right, then execute successive column movements until the column is faced in the desired direction.)

9008. TO FORM LINE FROM COLUMN. The purpose of this movement is to change the formation from a column back to a line. It may be executed when halted at attention and at order arms if armed with rifles. The command is **"Left, FACE."** (NOTE: If the platoon is in column at close interval they must be extended to normal interval, paragraph 9015, prior to executing left face. Otherwise there will not be 40 inches distance between ranks.) At the command of execution **"FACE,"** all members of the platoon face to the left, the platoon commander, if necessary, moves by the most direct route to a post 6 paces front and center of the platoon, and the platoon guide takes post on the right of the front rank. (NOTE: When in column, if the platoon is faced to the right it becomes inverted. This should only be done for short adjusting movements.)

9009. TO ALIGN THE PLATOON

1. The purpose of these movements is to dress the alignment of the platoon. They may be executed when the platoon is halted at attention in line or column. When in line, the commands are **"Dress Right (Left), DRESS"** or **"At Close Interval, Dress Right (Left), DRESS."** These commands are given only when the platoon is at approximately the same interval as the interval at which the dress is commanded. When in column, halted or marching, the command to dress alignment is **"COVER."**

2. Dress Right Dress

a. On the command **"Dress Right, DRESS,"** everyone except those individuals on the right flank, smartly turn their heads to the right, look, and align themselves. At the same time, everyone except those individuals on the left flank, provide interval by smartly raising their extended left arm to shoulder height and in line with their body. Fingers are extended and joined, thumb along the forefinger, palm down.

b. As the base of the movement, the guide stands fast and remains looking to the front. The first squad leader looks to the right and aligns on the guide. The other squad leaders cover the first squad leader and look to the front, ensuring they have a 40-inch distance. All other members position themselves by short steps until their right shoulders touch the fingertips of the person on their right.

c. The platoon commander, on his/her own command of execution **"DRESS,"** faces half left, as in marching, and proceeds by the most direct route to a position on line with the front rank and 1 pace to the guide's right (or first squad leader if there is no guide). (See figure 9-3a.) At this position, the platoon commander executes a halt while facing rear, and then executes a right face, facing down the line of the first rank. (See figure 9-3b.) The platoon commander aligns the front rank by commanding those individuals in advance or rear of the line to move forward or backward until in line. These individuals are designated by name or number. For example: **"Jones, FORWARD;"** or **"Number Three, BACKWARDS."** Those commanded to move will move the designated number of steps or will continue to move (taking small steps) until receiving the command **"STEADY."** The commander may execute a series of short side steps to the right or left in order to identify an individual. However, prior to commanding the identified individual to move, the commander will be on line with the rank. After verifying the alignment of the first rank, the platoon commander faces to the left as in marching, and moves to a position on line with the next rank. The 1 pace interval from the guide is maintained (this results in a 2 pace interval from the second and subsequent squad leaders). The commander halts on line with each succeeding rank, executes right face, and aligns the rank. (See figures 9-3c and d.) After verifying the alignment of the last rank, the platoon commander faces to the right in marching, marches straight to a point 3 paces beyond the front rank, maintaining the 1 pace interval to the guide's right, halts, (see figure 9-3e) faces to the left, (see figure 9-3f) and commands **"Ready, FRONT"** and **"COVER."** Immediately after commanding, **"COVER,"** the platoon commander marches by the most direct route back to a post 6 paces front and centered on the platoon, halts facing down line or to the front.

d. On the command **"Ready, FRONT,"** all members of the platoon who raised their left arm and turned their head to the right, will smartly but quietly lower their arm to their side and at the same time turn their head back to the front, assuming the position of attention. On the command **"COVER,"** all members of the second and subsequent ranks will cover on the individual in front of them.

e. When aligning a platoon of well-drilled troops or when there is insufficient time to verify alignment, the platoon commander may command **"Ready, FRONT"** and **"COVER"** from his/her normal position (6 paces front and centered), without having verified alignment.

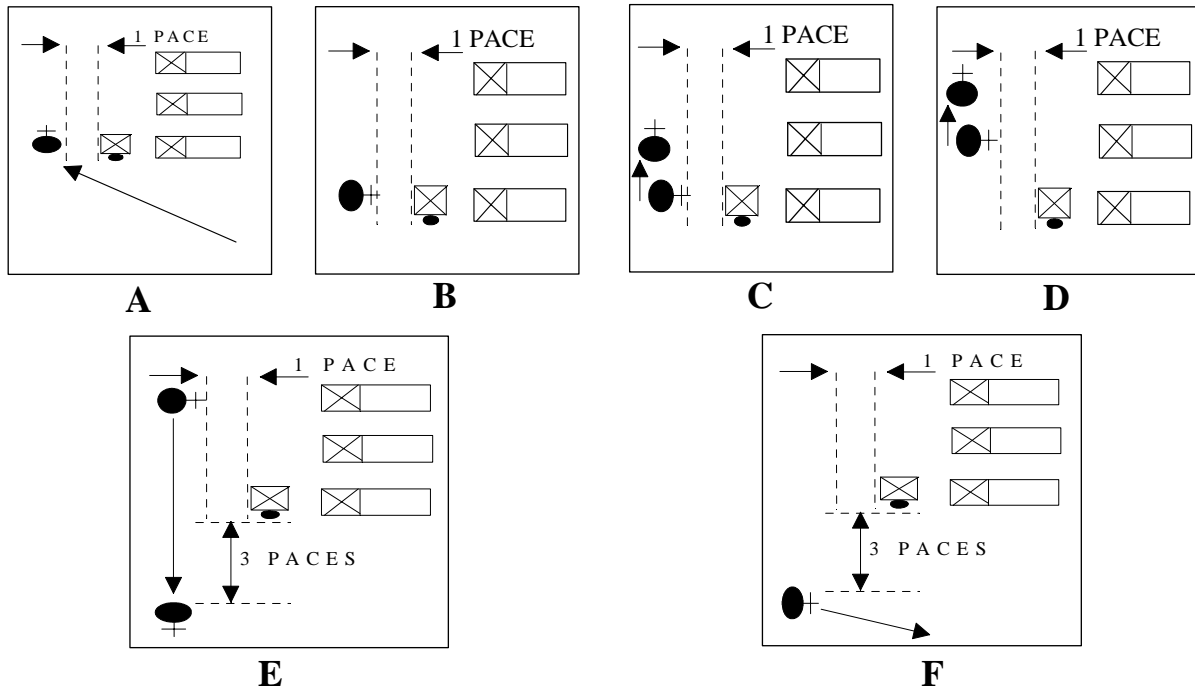

Figure 9-3.--Movements of the Platoon Commander when Aligning the Platoon.

3. At Close Interval Dress Right Dress. This movement is executed in the same manner as dress right dress except for the following: On the command **"At Close Interval, Dress Right, DRESS,"** those individuals providing interval will do so by placing the heel of their left hand on their hip with the elbow in line with their body. Fingers are extended and joined and pointing down. Members gaining interval will move by short steps until their right arm is touching the left elbow of the individual to their right.

4. Dress Left Dress and at Close Interval Dress Left Dress. These movements are similar to dress right dress and at close interval dress right dress except that alignment is made toward the left. The last individual in the first rank is the base of the movement and stands fast. On the command **"Dress Left, DRESS"** or **"At Close Interval, Dress Left, DRESS,"** everyone except those on the left flank smartly turn their heads to the left, look, and align themselves. At the same time they will smartly raise their left arm or elbow to provide interval (the left arm is used for both dress right and dress left). The last individuals in the second and subsequent ranks will cover the person in front of them and ensure that they have a 40-inch distance. The platoon commander will verify alignment of the platoon from its left flank.

## 5. Aligning in Column

a. The base squad for maintaining alignment while halted or marching in column is normally the third (right) squad. However, when executing a column left, column half left or eyes left alignment is to the first (left) squad. While marching, alignment is maintained by constantly glancing out of the corner of the right (left) eye, without turning the head.

b. Halted. When halted in column, (except for parades and ceremonies) the platoon is aligned by the command "COVER." At the command, the base squad leader obtains a 40-inch distance from the guide and covers on him/her. Other squad leaders obtain proper interval from the base squad leader and align toward the base by glancing out of the corner of their right (left) eye without turning their heads. Other members of the base squad obtain a 40-inch distance and covers on the person in front of them. At the same time, the remaining members of the platoon align on the base squad, by glancing out of the corner of their right (left) eye without turning the head and covers on the person in front of them. Only small adjusting steps are taken by platoon members to gain cover and alignment.

c. Marching. While marching, cover and alignment are constantly maintained by glancing out of the corner of the right (left) eye, without turning the head, to align on the base squad. The command of "COVER" is only given if required.

### 9010. TO OBTAIN CLOSE INTERVAL FROM NORMAL INTERVAL IN LINE

1. The purpose of this movement is to close the interval between files of a platoon in line to 4 inches. It may be executed when the platoon is halted at attention and in line at normal interval. The command is "**Close, MARCH.**"

2. The squad leaders are the base of this movement. On the command of execution "**MARCH,**" the squad leaders stand fast and place their left hand on their hip to provide interval for the individuals to their left. At the same time, all other members of the platoon, except for the guide, face to the right as in marching, march toward the right flank until approximately 4 inches from the person in front of them, halt, and face to the left. They then execute at close interval dress right dress. After aligning and without command, they will smartly lower their left hands and turn their heads to the front as soon as the individual to their left has touched their elbow with his/her right arm and stopped moving. Cover is then obtained without command.

3. On the command of execution, the guide will step to the left as in marching and close to 4 inches on the first squad leader. After halting and facing to the right, the guide will execute at close interval dress left dress. When aligned and at the proper interval the guide will return to the position of attention.

4. The platoon commander on his/her own command of execution "**MARCH**" will step to the left in marching. He/she marches parallel to the platoon maintaining a distance of 6 paces from the platoon. When approximately on the center of the platoon at close interval the platoon commander halts and faces the platoon. The platoon commander then adjusts to the center of the platoon by taking small steps left, right, forward or back.

9011. TO OBTAIN NORMAL INTERVAL FROM CLOSE INTERVAL IN LINE

1. The purpose of this movement is to extend the interval between files of a platoon in line to one arm length. It may be executed when the platoon is halted at attention and in line at close interval. The command is **"Extend, MARCH."**
2. The squad leaders are the base of this movement. On the command of execution **"MARCH,"** the squad leaders stand fast and raise their left arms to shoulder height to provide interval for the persons on their left. At the same time, all other members of the platoon, except for the guide, face to the left as in marching, march toward the left flank until they have opened approximately a 30-inch distance from the person behind them, halt, and face to the right. They then execute dress right dress. After aligning and without command, they will smartly lower their left arms and turn their heads to the front as soon as the individual to their left has touched their finger tips with his/her right shoulder and stopped moving. Cover is then obtained without command.
3. On the command of execution, the guide will take one step to the right as in marching, halt and face to the left. The guide will then execute dress left dress. When aligned on the first squad leader and at the proper interval the guide will return to the position of attention.
4. The platoon commander on his/her own command of execution **"MARCH"** will step to the right in marching. He/she marches parallel to the platoon maintaining a distance of 6 paces from the platoon. When approximately on the center of the platoon at normal interval the platoon commander halts and faces the platoon. The platoon commander then adjusts to the center of the platoon by taking small steps left, right, forward or back.

9012. TO OBTAIN DOUBLE ARM INTERVAL IN LINE

1. The purpose of this movement is to extend the interval between the files of a platoon to a double arm distance. It may be executed when the platoon is halted at attention and in line at normal or close interval. If armed, rifles must be at sling arms. The command is **"Take Interval to the Left, MARCH."**
2. The squad leaders are the base of this movement. On the command of execution **"MARCH,"** the squad leaders stand fast and raise their left arms to shoulder height, to provide interval for the persons on their left. The first squad leader will also raise his/her right arm to provide interval for the guide. At the same time, all other members of the platoon, except for the guide, face to the left as in marching, march toward the left flank until they have opened approximately a 70-inch distance from the person behind them, halt, and face to the right. They then smartly turn their heads to the right and raise both arms to shoulder height. Individuals on the left flank will only raise their right arm. After aligning and without command, they will smartly lower their right arms and turn their heads to the front as soon as they have proper interval. They will lower their left arms when they feel the individual to their left lower his/her right arm. Cover is then obtained without command.
3. On the command of execution, the guide will take two steps to the right as in marching, halt and face to the left. The guide will then execute dress left dress. When aligned on the first squad leader and at the proper interval, the guide will return to the position of attention. When the first squad leader feels the guide lower his/her left arm, the squad leader will lower his/her right arm.

4. The platoon commander on his/her own command of execution **"MARCH"** will step to the right in marching. He/she marches parallel to the platoon maintaining a distance of 6 paces from the platoon. When approximately on the center of the platoon at double arm interval the platoon commander halts and faces the platoon. The platoon commander then adjusts to the center of the platoon by taking small steps left, right, forward or back.

9013. TO OBTAIN NORMAL INTERVAL FROM DOUBLE ARM INTERVAL

1. The purpose of this movement is to decrease the interval between files of a platoon in line from double arm to normal interval. It can only be executed when the platoon is halted at attention and in line at a double arm interval. The command is **"Assemble to the Right, MARCH."** On the command of execution, the interval is reduced in a manner similar to close march; except that individuals halt approximately 30 inches from each other, face and execute the appropriate dress movement to obtain normal interval.

2. The platoon commander on his/her own command of execution **"MARCH"** will step to the left in marching. He/she marches parallel to the platoon maintaining a distance of 6 paces from the platoon. When approximately on the center of the platoon at normal interval the platoon commander halts and faces the platoon. The platoon commander then adjusts to the center of the platoon by taking small steps left, right, forward or back.

9014. TO OBTAIN CLOSE INTERVAL IN COLUMN

1. The purpose of this movement is to close the interval between files in a column to 4 inches. It may be executed when halted or marching at normal interval in column. The command is **"Close, MARCH."**

2. When halted and the guide is right, on the command **"MARCH,"** members of the base (right) squad will stand fast. Members of the squad next to the base squad will execute two right steps. The next squad to the left will execute four right steps. If there are four squads in the platoon, the first (left) squad will execute six right steps. While side stepping, cover and alignment will be maintained. Steps may be adjusted slightly so that a 4-inch interval is obtained. Upon completion of the designated number of steps, members of the squad will halt and resume the position of attention.

3. When marching and the guide is right, the command of execution **"MARCH"** is given as the right foot strikes the deck. At this command:

a. The base (right) squad takes one more 30-inch step with the left foot and then begins to half step. (See figure 9-4.)

b. The squad to the left of the base squad takes one more 30-inch step to the front with the left foot; execute right oblique toward the base squad for one step and then steps 30 inches back to the original front. The squad then begins to half step.

c. The next squad to the left takes one more 30-inch step to the front and then executes right oblique toward the base squad for three steps and steps 30 inches back to the original front. The squad then begins to half step.



d. If there are four squads in the platoon, the first (left) squad would execute the same movements as above except the members would take five steps in the oblique.

e. Steps in the oblique may be adjusted slightly so that a 4-inch interval is obtained.

f. At the command "**Forward, MARCH**" all squads resume taking 30-inch steps.

4. If the guide has been shifted to the left or center, the base squad will become the squad behind the guide. The commands of execution will be given as the left foot strikes the deck, if guide is left, or on either foot if guide is center. Side steps or oblique movements will be made toward the base squad as appropriate.

5. The platoon commander, on his/her command "**MARCH,**" oblique the number of steps necessary to remain parallel to the platoon and picks up the half step. The platoon commander picks up a full 30-inch step on his/her command of "**Forward, MARCH.**"

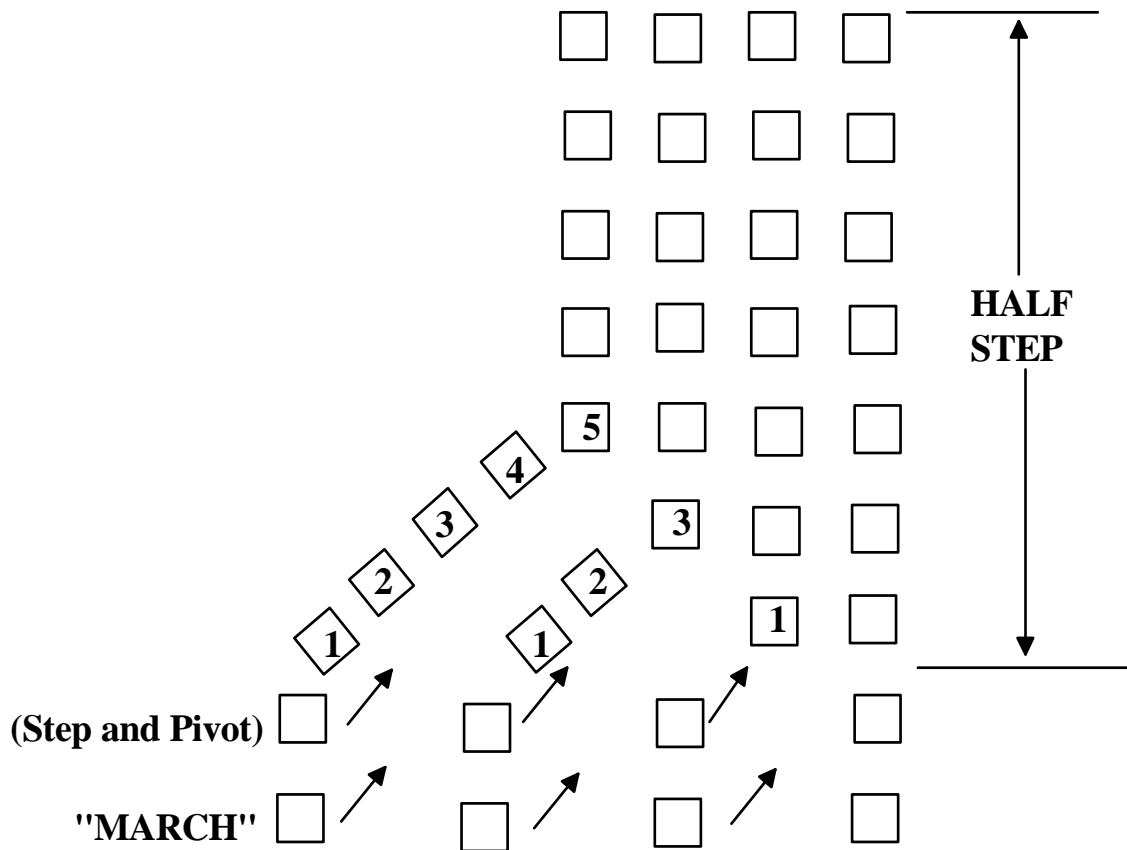

Figure 9-4.--Close March (While Marching), Right Squad Base.

9015. TO EXTEND TO NORMAL INTERVAL IN COLUMN

1. The purpose of this movement is to extend the interval between files in a column from close to normal interval. It may be executed when halted or marching in column at close interval. The command is **"Extend, MARCH."**
2. When halted and the guide is right, on the command of execution **"MARCH,"** members of the base (right) squad stand fast. Members of the squad next to the base squad will execute two left steps. The next squad to the left will execute four left steps. If there are four squads in the platoon, the first (left) squad will execute six left steps. While side stepping, cover and alignment will be maintained. Steps may be adjusted slightly so that one arms interval is obtained between squad leaders. Upon completion of the designated number of steps, members of the squad will halt and resume the position of attention.
3. When marching and the guide is right, the command of execution **"MARCH"** is given as the left foot strikes the deck. At this command:
  - a. The base (right) squad takes one more 30-inch step with the right foot and then begins to half step.
  - b. The squad next to the base squad takes one more 30-inch step to the front with the right foot, executes left oblique away from the base squad for one step and steps 30 inches back to the original front. The squad then begins to half step.
  - c. The next squad to the left takes one more 30-inch step to the front and then executes left oblique away from the base squad for three steps and steps 30 inches back to the original front. The squad then begins to half step.
  - d. If there are four squads in the platoon, the first (left) squad would execute the same movements as above except the members would take five steps in the oblique.
  - e. Steps in the oblique may be adjusted slightly so that a one-arm interval is obtained between squad leaders.
  - f. At the command **"Forward, MARCH,"** all squads resume taking 30-inch steps.
4. If the guide has been shifted to the left or center, the base squad will become the squad behind the guide. Side steps or oblique movements will then be made away from the base squad as appropriate.
5. The platoon commander, on his/her command **"MARCH,"** oblique the number of steps necessary to remain 6 paces from the platoon and picks up the half step. The platoon commander picks up a full 30-inch step on his/her command of **"Forward, MARCH."**

9016. TO OPEN RANKS

1. The purpose of this movement is to increase the distance between ranks to 70 inches in order to accommodate the movements of an inspection party or to stack arms. It may be executed when halted in line at attention, and at normal or close interval. If armed, rifles will be at order arms. The commands are **"At Close Interval, Open Rank," "MARCH;" "Ready, FRONT;"** and **"COVER."**

2. When at normal interval, on the command of execution **"MARCH,"** the front rank takes two 30-inch steps forward, halts, and executes dress right dress. The second rank takes one 30-inch step forward, halts, and executes dress right dress. The third rank stands fast and executes dress right. If there is a fourth rank, it takes two 15-inch back steps, halts, and executes dress right. When at close interval, all ranks will execute at close interval, dress right dress in place of dress right dress.

3. The platoon commander verifies alignment as for dress right dress, except that he/she will verify the 70-inch distance between ranks by taking two 30-inch steps and one 10-inch step when moving from one rank to the next. After verifying the alignment of the rear rank, he/she faces to the right in marching, marches 3 paces beyond the front rank, and 1 pace to the guide's right, halts, faces to the left, and commands **"Ready, FRONT"** and **"COVER."** The platoon responds to these commands in the same manner as when they are given following dress right dress.

a. If the platoon is about to be inspected the platoon commander, after the command **"COVER"** will take one step to the front so that he/she is 3 paces directly in front of the guide, and then execute a right face. From this position the platoon commander reports the platoon to the inspecting officer.

b. If the platoon is to stack arms, the platoon commander, on his/her command **"COVER"** will return by the most direct route to post 6 paces and centered in front of the platoon. The commands for stack arms would then be given, paragraph 9018.

#### 9017. TO CLOSE RANKS

1. The purpose of this movement is to decrease the distance between opened ranks to a normal distance (40 inches). It may only be given when the platoon is at attention at open ranks. The command is **"Close Ranks, MARCH."** It should be given immediately after the reason for opening ranks is accomplished, and before the platoon is given further drill movements or dismissed.

2. On the command of execution **"MARCH,"** the front rank stands fast while the second rank takes one 30-inch step to the front and halts. At the same time, the third rank takes two 30-inch steps to the front and if there is a fourth squad, it takes 3 steps and halts. Each individual maintains cover and alignment while moving. No dressing movements are executed.

3. The platoon commander may give the command to close ranks when:

a. After the platoon is inspected, the platoon commander returns to a position 3 paces in front of the guide and halts facing to the front. It is from this position that the inspecting officer would critique the inspection. The platoon commander would exchange salutes with the inspection officer and after that officer has departed, the platoon commander would face to the left and then command **"Close Ranks, MARCH."** The platoon commander, on the command **"MARCH,"** then moves to his/her position 6 paces and centered on the platoon.

b. After the platoon has taken arms, paragraph 9019, the platoon commander would command, **"Close Ranks, MARCH"** from his/her position 6 paces and centered in front of the platoon.

9018. TO STACK ARMS

1. The purpose of this movement is to temporarily relieve the platoon of its weapons. It may be executed when the platoon is halted in line. The command is **"Stack, ARMS;"** however, this command must be preceded by preliminary commands in order to prepare the platoon to stack arms. Assuming the platoon is halted in line at normal interval, the sequence of commands will be **"Count, OFF," "NUMBERS 3, 7, AND 11 ARE STACKMEN;"** **"Prepare, SLINGS;"** **"Open Ranks, MARCH;"** **"Ready, FRONT;"** **"COVER;"** and then **"Stack, ARMS."**

2. On the command **"Count, OFF,"** the platoon counts off as prescribed in paragraph 9006.

3. Stackmen are designated by file number with the command, **"NUMBERS 3, 7, AND 11 ARE STACKMEN."** In other words the number 3, 7, and 11 persons in each squad are designated as stackmen. Additional stackmen may be designated if the platoon has enough additional rifles to warrant it. The numbers 3, 7, and 11 are used to preserve fire team integrity for each weapons stack. If the squads are not divided into fire teams, numbers 2, 5, 8, and 11 may be designated stackmen. This reduces the number of extra weapons that must be added to the stacks.

4. On the command **"Prepare, SLINGS,"** the designated stackmen place the butt of their rifles on their right hip and cradle them in the crook of their right arm. They then adjust their slings to form a 4-inch loop next to the upper sling swivel with the sling on the left side. As soon as they have prepared the loop, they return to order arms.

5. When all stackmen have returned to order arms the platoon commander commands **"Open Ranks, MARCH,"** and ranks are opened as prescribed in paragraph 9016. After the platoon is aligned the platoon commander commands, **"Ready, FRONT"** and **"COVER."** He/she then moves to his/her position 6 paces and centered on the platoon prior to giving the next command.

6. On the command **"Stack, ARMS,"** the designated stackmen place their weapons directly in front of and centered on their bodies with the sights to the rear. The heel of the rifle butt is placed on the ground on line with the toes of their shoes. Each stacker grasps the rifle at the upper portion of the handguard with the left hand, keeping the rifle vertical. The first two fingers of the left hand hold the inner part of the loop against the rifle. The stacker reaches across the front of the rifle with the right hand, grasps the outer part of the loop and holds it open for insertion of the rifles. (See figure 8-9.) At the same time, the individuals to the left and right of the stackmen perform the following movements simultaneously:

a. The individuals on the stackmen's right raise and center their weapons by bringing their right wrists to shoulder height and centered on their bodies, magazine wells face the front. They then grasp the handguards (midway) with their left hands, release their right hand and re-grasp the weapon at the small of the stock. Arms are then lowered to a dead hang, so that the weapons are held in a horizontal position with the muzzles to the left and magazine wells still to the front. (See figure 8-9.)

b. The individuals on the stackmen's left raise and center their weapons by bringing their right wrists to shoulder height and centered on their bodies, magazine wells face the front. They then grasp their weapons at the small of the

stock with their left hands, release their right hands and re-grasp the handguards (midway). Arms are lowered to a dead hang so that the weapons are held in a horizontal position with the muzzles to the right and the magazine wells still to the front. (See figure 8-9.)

c. As soon as the stackmen have placed their rifles in position, both the individuals to the right and left move their feet 18 inches in the oblique toward the stackmen. The individuals on the stacker's left insert the muzzles of their rifles into the loops to a point approximately halfway between the compensator and the front sight. They hold their weapons in this position until the individuals on the stacker's right insert the muzzles of their rifles in a similar manner but above the other rifle in each loop. (See figure 8-10.)

d. The butts of the rifles inserted into the loops are swung outward and down to the ground until the stacks are tight with the rifle butts on line and approximately 2 feet forward of the stackmen's rifles. The rifles rest on the side of the butts with the pistol grips pointing inboard toward each other. As each stack is completed, all three individuals stand up at the same time and resume the position of attention. (See figure 8-11.)

e. Extra rifles are passed to the nearest stacks on the right. Individuals holding extra rifles grasp the barrels of their rifles, raise them vertically and then extend their right arms horizontally to the right front. The persons to the right grasp the weapons at the handguard, center them on their bodies, grasp the barrels with their right hands and extend their right arms horizontally to the right front. This action is repeated until the rifles reach the stackmen. The stackmen lean the rifles against the stacks in such a manner as to prevent them from falling or knocking the stacks over.

f. If the numbers 3, 7, and 11 were stackmen, the squad leaders would then pass their rifles to the stacker. The squad leaders pass their rifles to the first stack on the left by raising the weapon with the right hand to a position centered on the body. They then grasp the weapon with the left hand at the handguards and pass the weapon the left by extending the left arm horizontally to the left front. The individual to the squad leader's left then grasps the rifle at the barrel with the right hand, centers it on the body, grasps the handguards with the left hand and passes it to the stacker.

g. After the squad leader of the front rank has passed his/her weapon, the guide would then pass his/her weapon to the stacker in the same manner as the squad leaders.

#### 9019. TO TAKE ARMS

1. The purpose of this movement is to recover arms that have been stacked. It may be executed only when the platoon has fallen back in on the weapons stacks. The command is **"Take, ARMS."**

2. On the command of execution **"ARMS,"** if there are extra arms they are passed back in a reverse order and manner of the way they were passed to the stacks. When extra arms have been passed back, or if there were no extra arms, the stackmen grasp their rifles and hold the loops in the same manner as was done for stacking arms. The individuals to the left and right step in the oblique, reach down and

re-grasp their weapons and bring them to a horizontal position. Weapons are freed from the loops, individuals on the right first, and order or unsling arms is assumed. Stackmen cradle their rifles and adjust slings to their original position and then assume the order or unsling arms position.

3. Once everyone is at the position of order or unsling arms, the command **"Close Ranks, MARCH"** is given.

9020. TO FORM FOR PHYSICAL DRILL

1. The purpose of the movement is to form the platoon for physical exercise. It may be executed when the platoon is halted at attention and in a column of threes or fours at normal interval. If armed with rifles, they will be at order arms. The sequence of commands are: **"From Front to Rear, Count, OFF;" "Take Interval to the Left, MARCH;" "Arms, DOWN;"** and **"Even Numbers, To the Right, MOVE."** To reform to a column the commands are **"Assemble, MARCH"** and **"COVER."**

2. The command **"From Front to Rear, Count, OFF"** is given by the platoon commander in order to designate odd and even ranks. It is executed as prescribed for counting off in column.

3. The next command is **"Take Interval to the Left, MARCH."** This movement is different from the movement described in paragraph 9012, which is executed when the platoon is in line formation. With the platoon in column, the extended interval is set by designating the number of steps the members of each squad take to the left.

a. On the command of execution **"MARCH,"** all members of the squad on the right flank (third squad if it is a three squad platoon, fourth squad if it is a four squad platoon) and the guide, will cover in file, stand fast and each member extends both arms sideways at shoulder height, palms down with fingers extended and joined. If armed with rifles each member will grasp the barrel of the rifle with the right hand and raise it to shoulder height with the pistol grip and magazine well facing the front. This squad forms the base of the movement.

b. At the same time, the members of each squad to the left of the base squad will face to the left as in marching and take two, four, or six (if it is a four squad platoon) 30-inch steps respectively. Upon completing their designated number of steps, they will halt, execute a right face, will cover in file, stand fast, and extend their arms to the side at shoulder height in the same manner as the right file. If armed with rifles the rifles are carried at trail arms during movement and then raised in the same manner as the right file.

c. At the command **"Arms, DOWN,"** the arms are lowered smartly to the side and if armed with rifles the position of order arms is assumed.

4. On the command **"Even Numbers to the Right, MOVE,"** all even numbered individuals and the guide will move to their right to the middle of the interval between files. This will be done by swinging the right leg to the right and springing off the left foot. The movement should be completed in one hop. If armed with rifles the weapon is brought to trail arms and held against the right leg during movement. Once in position, even numbered members cover and assume the position of attention. Odd numbered members do not move. From this position physical drill may be executed without the danger of collisions between individuals.

5. Upon the completion of physical drill, the command **"Assemble, MARCH"** is given. On the command of execution, the odd numbered members of the base squad stand fast. Even numbered members of the base squad step left in marching and double time to their positions covered on the odd numbered members of the base squad and the guide will return to a position in front of the base squad leader. At the same time, all other members will face right as in marching and, at a double time cadence, reassemble in column at normal interval and stand fast. The platoon commander would then give the command of **"COVER"** in order for the platoon to quickly pick up its alignment and cover.

6. The platoon commander, once the platoon is in column, gives all commands from a position 6 paces in front of, centered on and facing the column. He/she makes those movements necessary to maintain this position during the execution of the movement(s).

#### 9021. TO CHANGE THE DIRECTION OF A COLUMN

1. The purpose of this movement is to change the direction of march of a column. It may be executed when the platoon is halted or marching in column at normal or close interval. The command is **"Column Right (Column Left, Column Half Right or Column Half Left), MARCH."** The base element during the turn is the squad on the flank in the direction of the turn. The leading member of the base squad, excluding the platoon commander and guide, establishes the pivot for the movement.

2. When marching, the commands of execution are given on the foot in the direction of the turn. On the command of execution **"MARCH,"** the leading member of the base squad takes one more 30-inch step to the front and then pivots 90 degrees to the right (left) on the ball of the left (right) foot. He/she then takes one 30-inch step in the new direction before beginning to half step. At the same time other members of the leading rank execute a right (left) oblique. They step in this direction until they are on line with the new line of march (normally two, four and six steps respectively) and then execute a second right (left) oblique. The original interval is maintained while in the oblique. Stepping out of the second oblique with a 30-inch step, they begin to half step as soon as they are aligned on the base squad leader. When all members of the same rank have come abreast, everyone in that rank resumes a full step. Ranks in rear of the leading rank execute the pivot movements on the same points and in the same way as the leading rank. (See figure 9-5.)

3. When halted, at the command of execution **"MARCH,"** the leading member of the base squad faces to the right (left) as in marching and takes one 30-inch step in the new direction with the right (left) foot. At the same time other members of the leading rank step off in the right (left) oblique. Members behind the lead rank step off to the front as in forward march. The remainder of the movement is executed the same as in marching.

4. During column movements, the platoon commander and guide execute either an oblique or a 90-degree pivot (depending on the direction of the movement) on the command of execution. After completing their turn, they adjust their line of march so that they are in front of the appropriate squad.

5. For slight changes of direction, the command is **"INCLINE TO THE RIGHT (LEFT)."** At that command, the guide changes direction as commanded. This is not a precision movement and is executed only while marching.

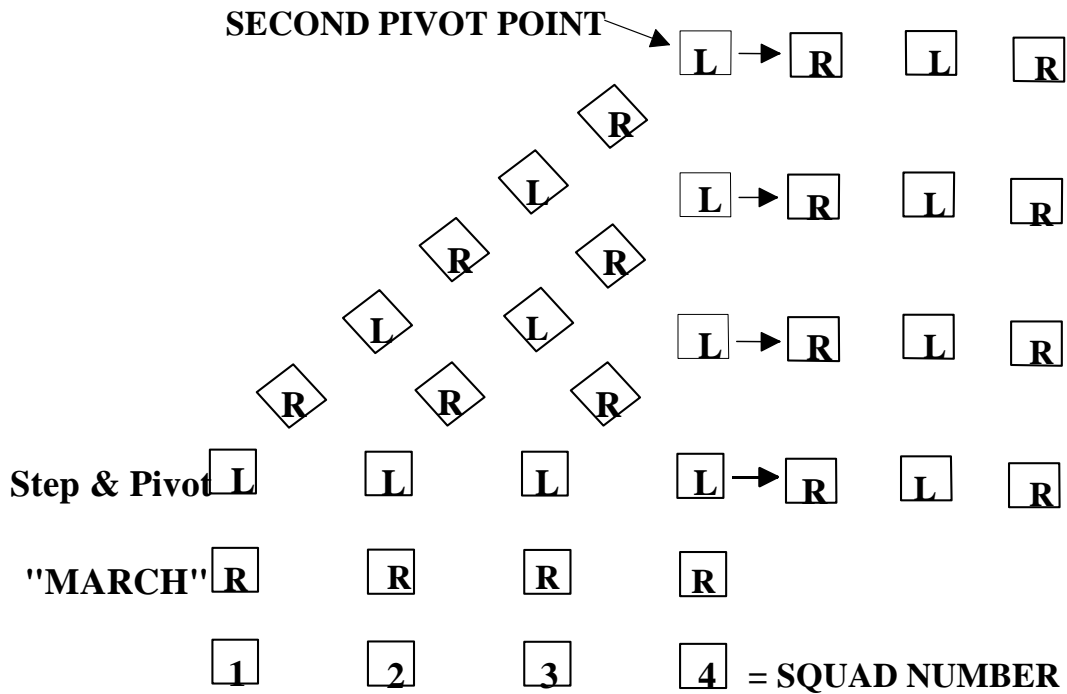

Figure 9-5.--Executing Column Right (Left).

9022. TO MARCH TO THE FLANK

1. The purpose of this movement is to march the platoon to the right or left flank for a short distance. It may be executed from any formation that is marching at quick time or double time cadence. The command is **"By the Right (Left) Flank, MARCH."** The command of execution is given as the foot in the direction of the turn strikes the deck.

2. To execute a right flank when marching at quick time, the command is **"By the Right Flank, MARCH."** On the command of execution **"MARCH,"** everyone takes one more 30-inch step to the front with the left foot and then pivots 90 degrees to the right on the ball of the left foot. Stepping out of the pivot with a 30-inch step, the entire platoon marches in line to the right flank. The platoon commander and guide execute the flanking movement with the platoon, but do not change their position within the platoon. (For the one exception to this, see paragraph 10011.) For the platoon to resume marching in the original direction, the command is **"By the Left Flank, MARCH."** To march to the left flank, substitute left for right and right for left in the above sequence. No other command may be given when marching to the flank until the unit has resumed marching to the original front. (See figure 9-6.)

3. When this movement is executed from a column at close interval, squad(s) to the rear of the squad that becomes the leading squad takes up the half step. They resume a full step as soon as a 40-inch distance has opened between squads. After such a movement, the platoon maintains normal interval until close march is commanded.



4. When marching at double time, on the command of execution **"MARCH,"** everyone takes two more 36-inch steps to the front and then two 6-inch vertical steps in place at double time cadence. While stepping in place, everyone turns 90 degrees toward the direction commanded and then steps off with a 36-inch step in the new direction.

5. When the platoon executes flank movements from a column at close interval, squad(s) to the rear of the squad that becomes the leading squad, will take up a half step. They resume a full step as soon as a 40-inch distance has opened between squads. After such a movement, the platoon maintains normal interval until close march is commanded.

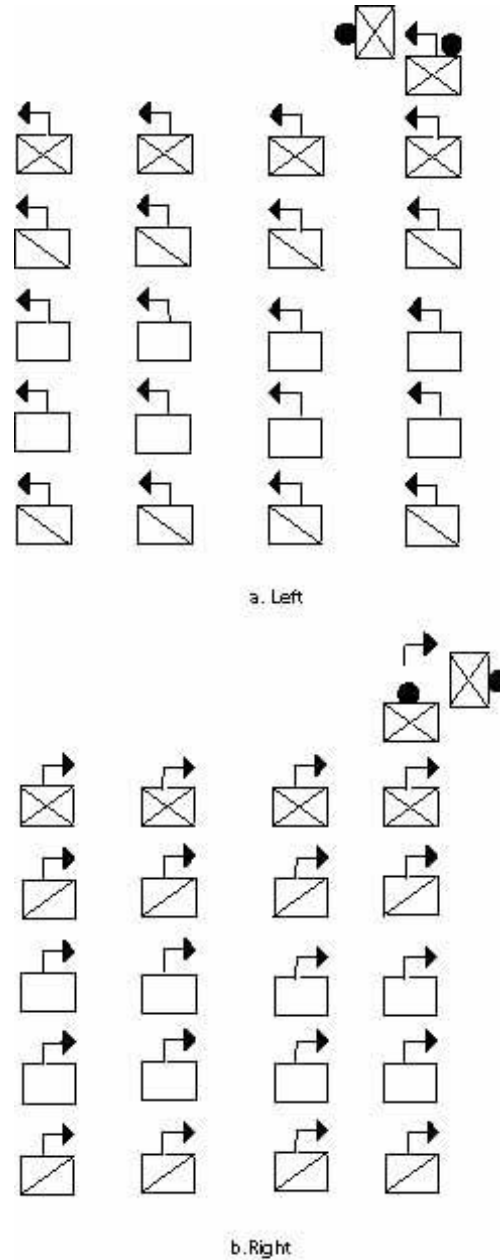

Figure 9-6.--Right (Left) Flank.

9023. TO MARCH IN THE OBLIQUE

1. The purpose of this movement is to shift the line of march to the right or left for a short distance and then resume marching in the original direction. It may be executed from any formation that is marching at quick time cadence. The command is **"Right (Left) Oblique, MARCH."** The word oblique is pronounced to rhyme with strike. The command of execution is given as the foot in the direction of the turn strikes the deck. The command to resume the original direction of march is **"Forward, MARCH."** The command of execution is given as the foot toward the original front strikes the deck.

2. To teach the platoon to march to the oblique, the instructor aligns the unit and has members face half right (left). The instructor then explains that these positions are maintained when marching to the oblique. This is achieved by individuals keeping their shoulders parallel to the persons in front and/or adjacent to them. The individual at the corner of the platoon towards the direction of the oblique is the base of the movement, and must maintain a steady line of march keeping his/her other shoulders blocked perpendicular to the direction of march.

3. To march the platoon in the right oblique, the command is **"Right Oblique, MARCH."** On the command **"MARCH,"** everyone then takes one more 30-inch step to the front with the left foot and pivots 45 degrees to the right on the ball of the left foot. Stepping out of the pivot with a 30-inch step, the entire platoon marches to the right oblique until given another command. (See figure 9-7.) For the platoon to resume marching in the original direction, the command is **"Forward, MARCH,"** in this case the command of execution will be given as the left foot strikes the deck. Everyone then takes one more step in the oblique direction with the right foot; pivots back to the original front and continue to march. To march to the left oblique, substitute left for right and right for left in the above sequence.

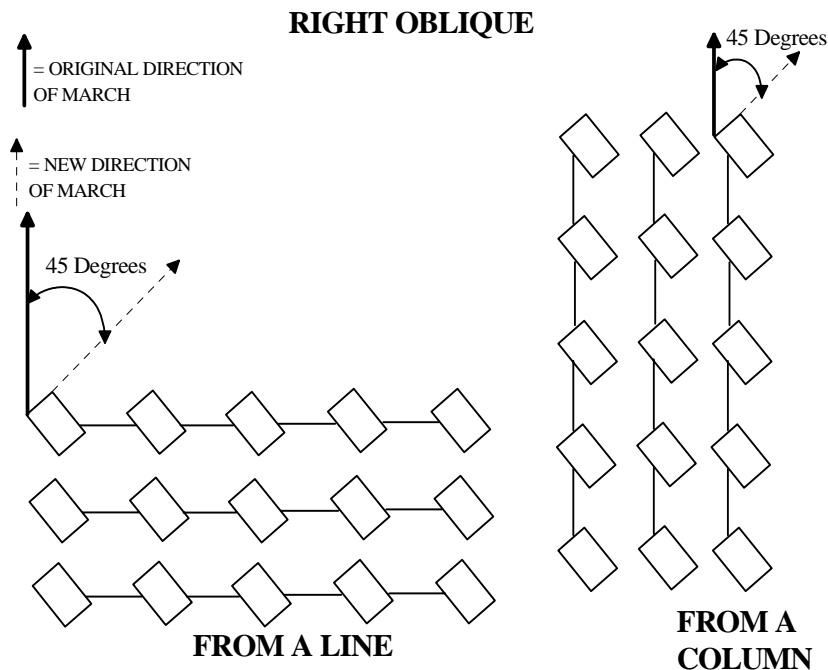

Figure 9-7.--Marching to Right Oblique.

4. To halt the squad facing in the original direction of march the command is **"Platoon, HALT."** The command of execution **"HALT"** is given on the left foot when marching to the right oblique, and on the right foot when marching to the left oblique. At the command **"HALT,"** everyone takes one more step in the oblique direction, pivots to the original front on the toe of the right (left) foot, and places the left (right) foot beside the other at the position of attention.
5. To temporarily halt the squad in the oblique direction, in order to correct errors, the command is **"In Place, HALT."** The command of execution **"HALT"** may be given as either foot strikes the deck. At the command of execution **"HALT,"** the squad halts in two counts as in quick time and remains facing in the oblique direction. The only command that can be given after halting in place is **"Resume, MARCH."** At that command the movement continues marching in the oblique direction.
6. When given half step or mark time while marching in the oblique, the only commands that may be given are, **"Resume, MARCH,"** to continue marching with a 30-inch step in the oblique; or **"In Place, HALT."** to halt in the oblique in order to correct errors.

9024. TO MARCH TO THE REAR

1. The purpose of this movement is to march the platoon to the rear for a short distance. It may be executed when halted or marching forward at quick time or double time. The command is **"To the Rear, MARCH"** it will be given as the right foot strikes the deck.
2. When halted, on the command of execution **"MARCH,"** everyone takes one 15-inch step to the front with the left foot and then pivots 180 degrees toward the right on the balls of both feet. Stepping out of the pivot with a 30-inch step, the entire platoon marches to the rear. For the platoon to resume marching in the original direction, the command **"To the Rear, MARCH"** is given again. No other command may be given when marching to the rear until the unit has resumed marching to the original front.
3. When marching at quick time, on the command of execution **"MARCH,"** everyone takes one more 15-inch step to the front with the left foot and then pivots 180 degrees toward the right on the balls of both feet. Stepping out of the pivot with a 30-inch step, the entire platoon marches to the rear. For the platoon to resume marching in the original direction, the command **"To the Rear, MARCH"** is given again. No other command may be given when marching to the rear until the unit has resumed marching to the original front.
4. When marching at double time, on the command of execution **"MARCH,"** everyone takes two more 36-inch steps to the front and then four 6-inch vertical steps in place at double time cadence. On the first and third steps in place, everyone pivots 180 degrees to the right. After the fourth step in place, and for the fifth step, they step off with a 36-inch step in the new direction. For the platoon to resume marching in the original direction, the command **"To the Rear, MARCH"** is given again. No other command may be given when marching to the rear until the unit has resumed marching to the original front.

9025. TO FORM A COLUMN OF TWOS OR FILES AND REFORM

1. The purpose of these movements is to diminish the front of the platoon in column. They may be executed when the platoon is halted at attention in column of threes or fours, and when at normal or close interval. Squads may be taken from either the right or left side of the platoon. The command to form a column of twos is **"Column of Twos from the Right (Left), MARCH."** The command to form a column of files is **"Column of Files from the Right (Left), MARCH."** When the squad leaders give supplemental commands they turn their head and eyes toward the direction of the movement, give the supplemental command, and turn their head and eyes back to the front. When commanding, **"Squad, HALT,"** the squad leaders turn their head and eyes in the direction of the halted element, regardless of the direction of the movement.

2. When forming a column of files or twos and reforming to threes (fours) it is important to note, in order to keep from inverting the platoon, that:

a. If a column of twos or files were taken FROM the LEFT, then a column of threes (fours) must be formed TO the RIGHT.

b. If a column of twos or files were taken FROM the RIGHT, then a column of threes (fours) must be formed TO the LEFT.

3. When in a Column of Threes, to Form a Column of Twos and Reform

a. On the preparatory command **"Column of Twos from the Right,"** the squad leaders give the following supplementary commands: the two right squad leaders turn their head and eyes to the right give the supplemental command **"Forward,"** the left squad leader turns his/her head and eyes to the left and gives the supplemental command **"Column of Twos to the Left."** The guide remains in position. On the platoon commander's command of execution **"MARCH,"** the two right squads march forward; the left squad forms a column of twos to the left as prescribed in squad drill. (See paragraph 8014.) Then, on commands of its squad leader, the remaining squad executes a column half right and a column half left so as to follow the two leading squads at normal distance in column. (See figure 9-8.)

b. To reform into a column of threes the command is **"Column of Threes to the Left, MARCH."** On the preparatory command, the two lead squad leaders turn their head and eyes to the left and give the supplementary **"STAND FAST."** The remaining squad leader then turns his/her head and eyes to the left and commands **"Column of Files from the Right"** and **"Column Half Left."** On the platoon commander's command of execution **"MARCH,"** the two leading squads stand fast; the rear squad forms single file from the right.

(1) The squad leader steps half left in marching turns his/her head and eyes to the right and quickly commands **"Column Half Right, MARCH,"** and executes the command so as to be marching to the left of and parallel to, the lead squads. He/she would continue to march forward until nearing the lead squad leaders, at which time the squad leader turns his/her head and eyes to the right and gives the command **"Squad, HALT."** The squad is halted so that it is aligned with, and the proper interval from, the two lead squads. (See figure 9-8.)

(2) The remaining members of the squad step off by twos (two and three; four and five; six and seven; etc.) in the left oblique. The even numbered members of the squad take one step in the left oblique and pivot back to the original direction of march, following the squad leader. The odd numbered members of the

squad take three steps in the left oblique and pivot back to the original direction of march, following the squad leader. The steps in the oblique may be adjusted so as to obtain proper interval from the two lead squads.

c. To form a column of twos from the left and reform to a column of threes to the right, use the same procedure as described in paragraph 9025.3b above substituting left for right and right for left. On the platoon commander's preparatory command of **"Column of Twos from the Left,"** the guide changes position to be in front of the second squad leader. When reforming to threes, after all squads have halted, the guide moves back in front of the third squad leader.

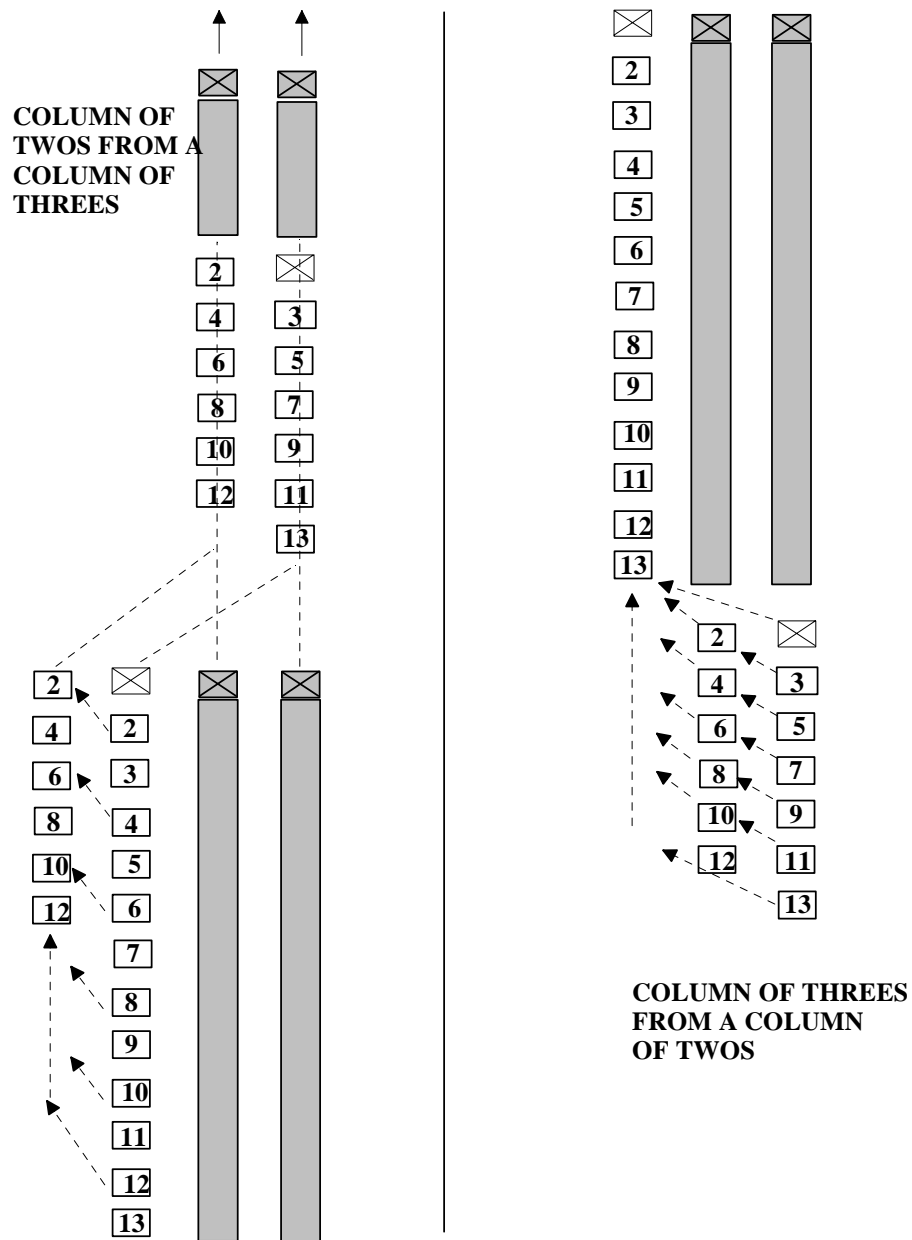

Figure 9-8.--Column of Twos from Column of Threes and Reform.

#### 4. When in a Column of Fours, to Form a Column of Twos and Reform

a. To form a column of twos from a column of fours the command is **"Column of Twos from the Right, MARCH."** On the preparatory command **"Column of Twos from the Right,"** the squad leaders give the following supplementary commands: the two right squad leaders simultaneously turn their head and eyes to the right and give the supplemental command **"Forward."** Then the two left squad leader simultaneously turn their head and eyes to the right and give the supplemental command **"STAND FAST."** The guide remains in position. On the platoon commander's command of execution **"MARCH,"** the two right squads march forward; the two left squads stand fast. When the two left squad leaders are about to be passed by the end of the two right squads they simultaneously turn their head and eyes to the right and command **"Column Half Right, MARCH."** They then step half right in marching, and in unison, command **"Column Half Left, MARCH"** so to follow the two leading squads at the proper distance. (See figure 9-9.)

b. To reform from a column of twos to a column of fours the command is **"Column of Fours to the Left, MARCH."** On the preparatory command **"Column of Fours to the Left,"** the squad leaders give the following supplementary commands: the two lead squad leaders simultaneously turn their head and eyes to the left and command **"STAND FAST;"** the two rear squad leaders then simultaneously turn their head and eyes to the left and command **"Column Half Left."** On the command of execution **"MARCH:"**

(1) The two lead squads stand fast.

(2) The two rear squads execute a column half left from the halt. The two squad leaders then simultaneously turns their head and eyes to the right and command **"Column Half Right, MARCH"** so to be marching to the left of and parallel to the lead squads. They would continue to march forward until nearing the lead squad leaders, at which time the squad leader simultaneously turn their head and eyes to the right and give the command **"Squad, HALT."** The squads are halted so that it is aligned with, and the proper interval from the two lead squads.

c. To form a column of twos from the left and reform to a column of fours to the right, use the same procedure as described in paragraph 9025.4b above substituting left for right and right for left. On the platoon commander's preparatory command of **"Column of Twos from the Left,"** the guide changes position to be in front of the second squad leader. When reforming to fours, after all squads have halted, the guide moves back in front of the fourth squad leader.

#### 5. When in a Column of Threes, to Form a Column of Files and Reform

a. On the preparatory command **"Column of Files From the Right,"** squad leaders turn their head and eyes to the right and give the following supplementary commands. The third squad leader commands **"Forward."** The remaining squad leaders command **"STAND FAST."** The guide remains in position. On the platoon commander's command of execution **"MARCH,"** the third squad marches forward; the remaining squads stand fast, then as the fourth to the last member of the squad to the right is about to pass their position the squad leader. (See figure 9-10.)

(1) The second squad leader turns his/her head and eyes to the right and commands **"Column Half Right, Column Half Left, MARCH."** The squad leader on his/her own command of execution **"MARCH,"** steps in the right oblique then pivots back to the left, so as to march at normal distance in single file behind the leading squad. The remaining squad members march forward and execute the pivots on the same point as established by the squad leader.

(2) The first squad leader turns his/her head and eyes to the right and commands **"Column Half Right, MARCH"** and **"Column Half Left, MARCH,"** so as to march at normal distance in single file behind the leading squad.

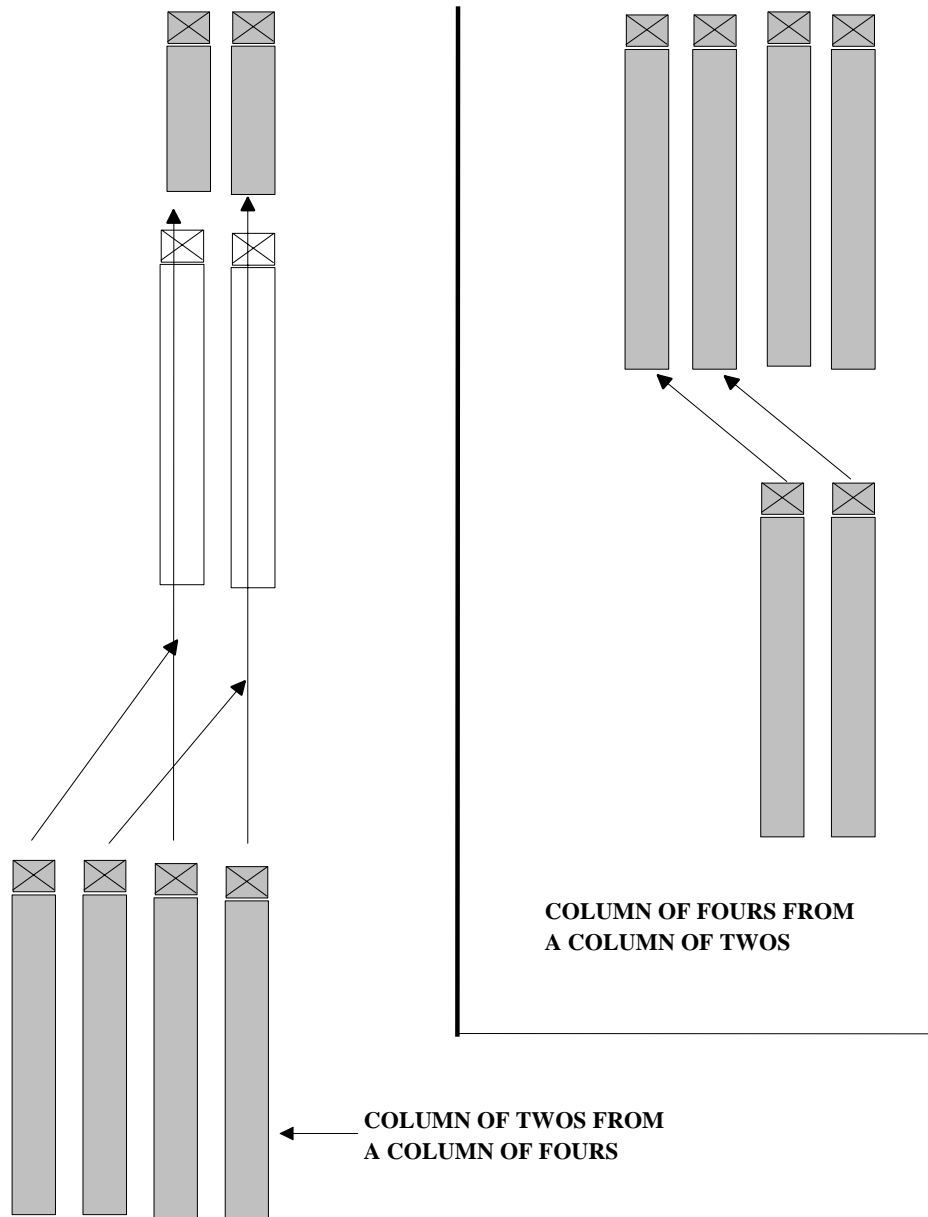

Figure 9-9.--Column of Twos from Column of Fours and Reform.

b. To reform into a column of threes, the command is **"Column of Threes to the Left, MARCH."** On the preparatory command, squad leaders, in sequence, give the following supplementary commands: the third squad leader turns his/her head and eyes to the left and commands **"STAND FAST;"** the second squad leader turns his/her head and eyes to the left and commands **"Column Half Left, Column Half Right;"** and the first squad leader turns his/her head and eyes to the left and commands **"Forward."** On the platoon commander's command of execution **"MARCH:"**

(1) The leading squad stands fast.

(2) The second squad leader takes one step in the left oblique then pivots back to the right, so as to be marching to the left of and parallel to the lead squad. The remaining squad members march forward and execute the pivots on the same point as established by the squad leader. The squad leader would continue to march forward until nearing the lead squad leader, at which time he/she turns his/her head and eyes to the right and gives the command **"Squad, HALT."** The squad is halted so that it is aligned with, and the proper interval from the two lead squads.

(3) The first squad marches forward until approaching the end of the lead squad. The squad leader then turns his/her head and eyes to the left and commands, **"Column Half Left, MARCH."** The squad leader then turns his/her head and eyes to the right and commands **"Column Half Right, MARCH"** in order to place his/her squad to the left of and at proper interval from the second squad. The squad would continue to march forward until nearing the second squad leaders, at which time the squad leader turns his head/her and eyes to the right and gives the command **"Squad, HALT."** The squad is halted so that it is aligned with, and the proper interval from the two lead squads.

c. To form a column of files from the left and reform to a column of threes to the right, use the same procedure as described in paragraphs 9025.5b(2) and (3) above substituting left for right and right for left. On the platoon commander's preparatory command of **"Column of Files from the Left,"** the guide changes position to be in front of the first squad leader. When reforming to threes, after all squads have halted, the guide moves back in front of the third squad leader.

6. Forming a column of files and reforming when in a column of fours is executed in a similar manner as when in a column of threes.

7. When marching in column of twos, the platoon commander is ahead of the left file and the guide is in front of the right file. When marching in single file, the guide leads the platoon, the platoon commander marches abreast of and to the left of the guide. If executing the movements for practice or instructional purposes the platoon commander would position himself/herself where he/she could best supervise the platoon.



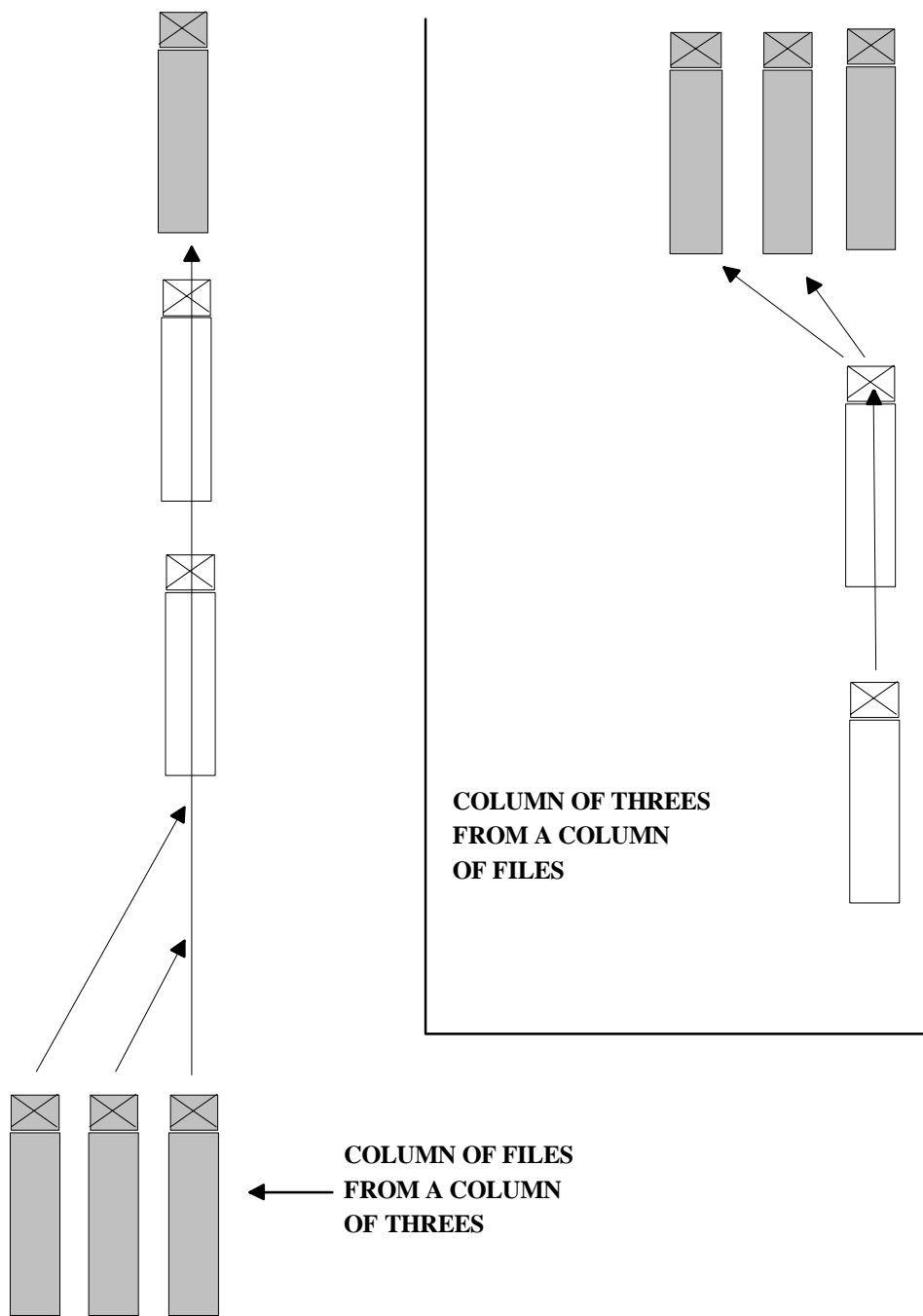

Figure 9-10.--Column of Files from Column of Threes and Reform.

MARINE CORPS DRILL AND CEREMONIES MANUAL

PART I: DRILL

CHAPTER 10

COMPANY DRILL

	<u>PARAGRAPH</u>	<u>PAGE</u>
GENERAL . . . . .	10000	10-3
RULES FOR COMPANY DRILL . . . . .	10001	10-4
TO FORM THE COMPANY . . . . .	10002	10-5
TO DISMISS THE COMPANY . . . . .	10003	10-7
BEING IN LINE, TO FORM COLUMN AND REFORM INTO LINE . . . . .	10004	10-8
TO ALIGN THE COMPANY . . . . .	10005	10-9
BEING IN COLUMN, TO CHANGE DIRECTION . . . . .	10006	10-10
BEING IN COLUMN, TO FORM MASS FORMATION . . . . .	10007	10-10
BEING IN COLUMN, TO FORM EXTENDED MASS FORMATION . . . . .	10008	10-12
BEING IN MASS OR EXTENDED MASS FORMATION, TO CHANGE DIRECTION . . . . .	10009	10-13
BEING IN MASS OR EXTENDED MASS FORMATION, TO FORM COLUMN . . . . .	10010	10-13
BEING IN COLUMN, TO FORM COLUMN OF PLATOONS IN LINE . . . . .	10011	10-14
BEING IN COLUMN OF PLATOONS IN LINE, TO FORM COLUMN . . . . .	10012	10-15
BEING IN COLUMN, TO FORM COLUMN OF TWOS OR FILES AND REFORM . . . . .	10013	10-16
COMPANY AWARDS FORMATIONS . . . . .	10014	10-17

FIGURE

10-1 COMPANY IN LINE FORMATION . . . . .	10-7
10-2 COMPANY IN COLUMN FORMATION . . . . .	10-8
10-3 COMPANY MASS FORMATION . . . . .	10-11
10-4 COMPANY IN EXTENDED MASS FORMATION . . . . .	10-13
10-5 COLUMN OF PLATOONS IN LINE FORMATION . . . . .	10-15
10-6 PLACING OF AWARD RECIPIENTS FOR THE CEREMONY . . . . .	10-17
10-7 MOVEMENTS OF THE AWARD RECIPIENTS . . . . .	10-19



MARINE CORPS DRILL AND CEREMONIES MANUAL

PART I: DRILL

CHAPTER 10

COMPANY DRILL

10000. GENERAL

1. A company consists of a company headquarters and two or more platoons.
2. For close order drill and ceremonies, company headquarters personnel may be attached to platoons without interfering with the permanent squad organization. For marches, members of the company headquarters command group are formed as directed by the company commander or higher authority.
3. Formations used by the company are line, column (of threes, etc.), mass, extended mass, and column of platoons in line. In all these formations, the platoons that comprise the company will either be in line (each squad forming one rank) or in column (each squad forming one file). The company may also form column of twos or files in a manner similar to that prescribed for a platoon, in which case the platoons are arranged as in column, except that each platoon is in column of twos or files. Formations of the company for drills and ceremonies, to include posts of officers and key noncommissioned officers, are shown in figures 10-1 through 10-5.
  - a. When the company commander is absent, the senior officer present with the company takes post and drills the company as prescribed for the company commander. In the absence of the first sergeant, the senior noncommissioned officer (normally the gunnery sergeant) takes post and performs the duties of first sergeant.
  - b. When officers are not present, after the company is formed, the first sergeant, or in his/her absence, the next senior staff noncommissioned or noncommissioned officer takes post and drills the company as prescribed for the company commander, and platoon sergeants take post and perform the duties of platoon commanders. This also applies when, for any reason, the company commander directs the first sergeant (or senior staff noncommissioned or noncommissioned officer) to take charge of the company for purposes other than dismissing the company. When this occurs, the officers retire and the first sergeant and platoon sergeants march by the most direct route to take post as the company commander and platoon commanders, respectively.
  - c. For drill and ceremonies, the following minimum key billets within the company must be filled by applying the above rules: company commander, guidon bearer, and first sergeant in the company headquarters; and a platoon commander, platoon sergeant, and guide for each platoon, plus one squad leader per squad within each platoon. (NOTE: When officers are not present and the first sergeant and platoon sergeants are acting as company commander and platoon commanders respectively, other noncommissioned officers need not be detailed to also act as first sergeant and/or platoon sergeants.)
  - d. For drill and ceremonies, the company guidon is carried by the guidon bearer. In all formations, the guidon bearer is 1 pace to the rear and 1 pace to the left of the company commander or first sergeant, as appropriate. For marches in the field, the guidon is kept with company headquarters baggage unless otherwise directed. If carried on marches in the field, the guidon bearer takes post as described above for drill and ceremonies.

4. During company physical training and conditioning marches when the company is in column, the first sergeant will move from his/her normal position at the rear of the column and assume a position to the left of the company commander. If the guidon is also present it will be carried on the march or run to the rear of the company commander and first sergeant.

10001. RULES FOR COMPANY DRILL

1. The platoon, rather than the company, is the basic drill unit. Only such formations are prescribed for the company as are necessary for marches, drills, and ceremonies.

→ 2. In company drill, if all Marines in the unit are to execute the same movement simultaneously, platoon commanders will repeat preparatory commands of the company commander except:

a. When commands such as "**FALL OUT**" are given, which combine the preparatory command and command of execution.

b. When the preparatory command of the company commander is "**Company,**" the platoon commanders give the preparatory command "**Platoon.**"

c. When in mass formation, platoon commanders repeat preparatory commands only when the order will require independent movement by a platoon.

d. When the platoons of the company are to execute a movement in successive order, such as a column movement, the platoon commander of the first platoon to execute the movement repeats the company commander's preparatory command, and those of following platoons give an appropriate caution such as "**Continue to March.**" Platoon commanders of following platoons repeat the company commander's preparatory command and command of execution at the proper time to cause their platoons to execute the movement on the same ground as the first platoon.

e. When participating in parades and ceremonies when commands by the adjutant, commander of troops, or company commander can be clearly heard, supplemental commands need not be given.

3. Platoon commanders turn their head and eyes when giving supplemental commands using the following rules.

a. When executing halted movements, such as the manual of arms, the platoon commander turns his/her head and eyes to the right.

b. For movements that involve marching, (e.g., forming from column into mass, mass into column or column movements) the platoon commander turns his/her head and eyes to the direction of the movement to give supplemental command.

c. When bringing the platoon on line with a halted element the platoon commander turns his/her head and eyes towards the halted element to give the command of mark time or halt.

4. When commands involve movements of the company in which one platoon stands fast or continues the march, while one or more of the others do not, its commander commands "**STAND FAST**" or "**Continue to March,**" as the case may be.

Enclosure (1)

5. The company marches, executes change of direction, closes and extends intervals between squads in column, opens and closes ranks, and stacks and takes arms as in platoon drill.
6. The company executes marching in line only for minor changes in position.
7. Unless otherwise specified for the company to be at close interval, all changes in formation must be executed with files and ranks formed at normal interval and distance.

#### 10002. TO FORM THE COMPANY

1. At the command "**FALL IN,**" the company forms in line formation at normal interval and distance. If it is desired to form the company at close interval between files, the command "**At Close Interval, FALL IN**" is given. In this case, the platoons form in line, but files within each platoon are at close interval (4 inches). The company forms at close interval only for roll calls or when space is limited. The company may be formed by its staff noncommissioned or noncommissioned officers under charge of the first sergeant, or by its officers under command of the company commander, as described below.

#### 2. Forming the Company by Noncommissioned Officers

a. The first sergeant takes post 9 paces in front of the point where the center of the company is to be, faces that point, draws sword if so armed, and commands "**FALL IN**" ("**At Close Interval, FALL IN**"). At this command, the guidon bearer takes post facing the front 1 pace to the front and 1 pace to the right of the first sergeant (the first sergeant facing the company), and the company forms in line with platoons in line at normal (close) interval and 4 paces between platoons. Each platoon sergeant takes post 3 paces in front of and facing the point where the center of the platoon is to be, faces that point, and draws sword if so armed. Each platoon then forms (as prescribed in paragraph 9004), under the supervision of the platoon sergeant.

b. Platoon sergeants then command "**REPORT.**" Remaining in position (at order arms if armed with the rifle), the squad leaders, in succession from front to rear in each platoon, salute and report, "All present," or "Private \_\_\_\_\_ absent." Platoon sergeants then command "**Inspection, ARMS;**" "**Port, ARMS;**" and "**Order, ARMS**" if troops are armed with rifles, then face about to the front. If troops are not armed with rifles, the platoon sergeant immediately faces the front after receiving the reports of the squad leaders. (NOTE: If platoons cannot be formed in regularly organized squads prior to forming the company, the platoon sergeants command "**Inspection, ARMS;**" "**Port, ARMS;**" "**Right Shoulder, ARMS;**" and call the roll. Each Marine answers "here," and goes to order arms as their name is called. The platoon sergeant then organizes the platoon into squads and faces the front. The manual of arms is omitted for personnel not armed with rifles.)

c. After all platoon sergeants have completed receiving the reports of their squad leaders and are facing the front, the first sergeant commands "**REPORT,**" at which time the platoon sergeants, beginning with the right platoon, successively salute and report, "All present or accounted for" or "\_\_\_\_\_ men absent." The first sergeant returns each salute individually. What occurs next depends upon whether the company commander and platoon commanders receive the company or not.

(1) If company officers do not receive the formation, after receiving the reports of all the platoon sergeants, the first sergeant commands, "**POST.**" On this command, the platoon sergeants and guidon bearer step forward three steps; simultaneously, the first sergeant faces about and steps forward three steps. The company is now formed with the first sergeant and platoon sergeants occupying the posts prescribed for the company commander and platoon commanders.

(2) If company officers receive the formation, the company commander and platoon commanders normally observe the initial procedures from a location to the rear of where the company is forming (officers remain with swords in their scabbards, if so armed). In this case, after receiving the reports of the platoon sergeants, the first sergeant faces the front and awaits the arrival of the company commander. When the company commander has taken post 12 paces front and center of the company, the first sergeant salutes and reports "Sir/Ma'am, all present or accounted for." or "Sir/Ma'am, \_\_\_\_\_ Marines absent." The company commander returns the salute, and may discuss absentees and issue necessary instructions to the first sergeant. Next, the company commander directs the first sergeant to "**TAKE YOUR POST,**" at which the guidon bearer marches forward 3 paces, and the first sergeant and platoon sergeants march by the most direct routes to their posts, the former in rear of the company, the latter on the left of the rear rank of their platoons; simultaneously, the company executive officer takes post to the rear of the company and the platoon commanders move around the right front of their platoons and take their posts 6 paces front and center of their platoons. After all officers are in position, if armed with the sword, the company commander draws sword; the company executive officer and platoon commanders draw sword with the company commander.

### 3. Forming the Company by Officers

a. Normally, the company is initially formed by the staff noncommissioned or noncommissioned officers, then received by the officers as described in paragraph 10002 above. This permits detailed musters to be taken by the staff noncommissioned or noncommissioned officers. During the course of training, if the company has been dismissed for a short period of time, it may be initially reformed by the company commander to save time.

b. When the company is initially formed by the company commander, the procedures are the same as forming with the staff noncommissioned or noncommissioned officers, except that the company commander takes post 12 paces front and center and facing the point where the center of the company is to be, draws sword if so armed, and commands "**FALL IN.**" Platoon commanders then take posts 6 paces front and center and facing the point where the center of their platoons will be, draw sword if so armed, form their platoons and receive the reports of their squad leaders, then face the front. After all platoon commanders have formed their platoons and are facing the front, the company commander commands "**REPORT,**" at which time each platoon commander, in succession from right to left, salutes and reports, "Sir/Ma'am, all present or accounted for," or "Sir/Ma'am, Marines absent."

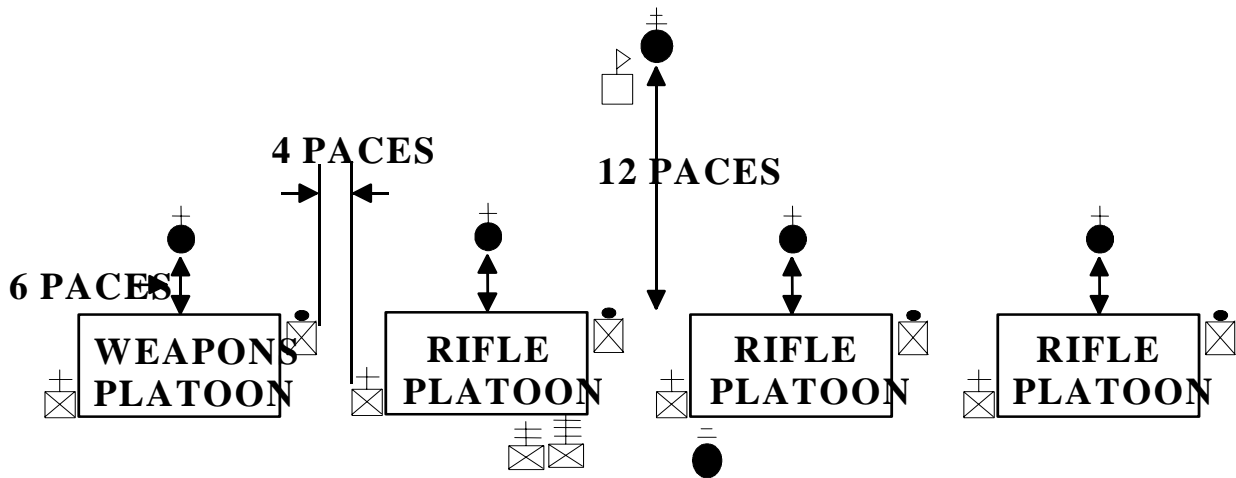

Figure 10-1.--Company in Line Formation.

10003. TO DISMISS THE COMPANY

1. The commands are **"FIRST SERGEANT"** and **"DISMISS THE COMPANY."** The company being in line at a halt, at the command **"FIRST SERGEANT,"** the first sergeant moves by the most direct route to a point 3 paces from the company commander (9 paces in front of the center of the company), halts, and salutes the company commander returns the salute and passes any directions or information necessary to the first sergeant. The company commander directs the first sergeant to **"DISMISS THE COMPANY."** The first sergeant and company commander exchange salutes. After returning the first sergeant's salute the company commander, returns sword, if so armed, and falls out. Other officers of the company return sword, if so armed, and fall out at the same time and in the same manner as described in paragraph 10002.2c(2). The platoon sergeants take their posts 3 paces in front of the centers of their platoons. The first sergeant, when the company commander returns his/her salute, executes an about face. When the platoon sergeants have taken their positions, the first sergeant commands **"Inspection, ARMS;" "Port, ARMS;"** and **"DISMISSED."**

2. The company being in line at a halt, dismissal may also be ordered by the command **"DISMISS YOUR PLATOONS."** The platoon commanders salute; the company commander returns their salute, returns sword, if so armed, and falls out. The platoon commanders execute about face and command **"PLATOON SERGEANT."** The platoon sergeant takes his/her post 3 paces in front of the center of the platoon halts, facing the platoon commander and salutes. The platoon commander returns the salute and passes any directions or information necessary to the platoon sergeant. The platoon commander then directs the platoon sergeant to **"DISMISS THE PLATOON,"** the platoon sergeant and platoon commander exchange salutes. After the platoon commander has returned the platoon sergeant's salute, he/she returns sword if so armed, and falls out. The platoon sergeant then faces the platoon and commands **"Inspection, ARMS;" "Port, ARMS;"** and **"DISMISSED."**

3. The first sergeant may cause platoons to be dismissed by the platoon sergeants by commanding **"DISMISS YOUR PLATOONS."** The platoon sergeants salute; the first sergeant returns the salute, returns sword if so armed, and falls out. The platoon sergeants then execute about face and command **"Inspection, ARMS;" "Port, ARMS;"** and **"DISMISSED."**



10004. BEING IN LINE, TO FORM COLUMN AND REFORM INTO LINE

1. Being at a halt and at the order in line, to form column, the company commander orders **"Right, FACE."** After facing to the right, all officers, key staff noncommissioned or noncommissioned officers, and the guidon bearer march by the most direct routes to their posts in column. The company commander may then cause the column to march (NOTE: As platoons and squads become inverted if the company is faced to the left, this should be done only for short movements.).

2. Being at a halt and at the order in column, to form line, the company commander commands **"Left, FACE."** (NOTE: If the company is at close interval they must be extended to normal interval, paragraph 9015, prior to executing left face. Otherwise there will not be 40 inches of distance between ranks.) After facing to the left, all officers, key noncommissioned officers, and the guidon bearer march by the most direct routes to their posts in line. (NOTE: When in column, if the company is faced to the right, platoons and squads become inverted. Therefore, to form line facing the right flank of a column, the company should first be marched by executing necessary changes in direction, so that after halting and facing to the left, line will be formed facing the desired direction.)

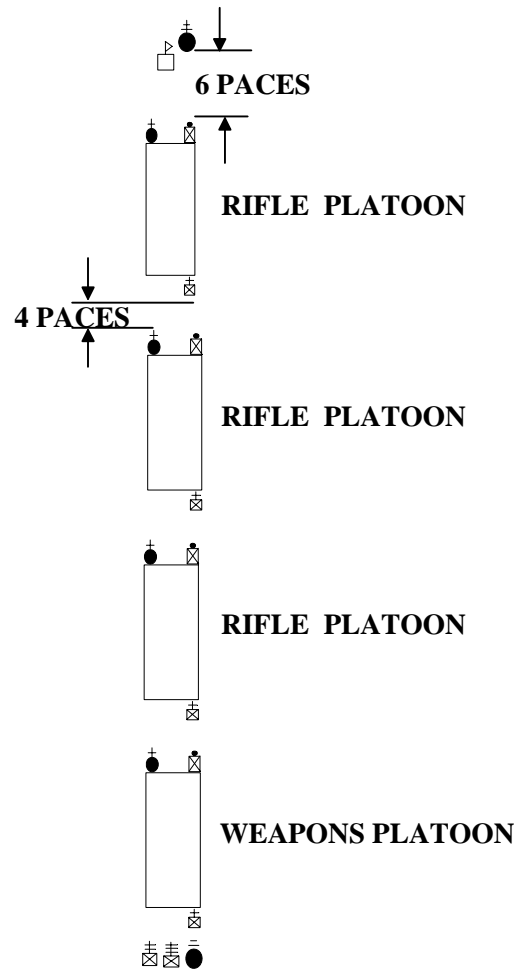

Figure 10-2.--Company in Column Formation.

10005. TO ALIGN THE COMPANY

1. To align the company when in line at a halt, the company commander commands, **"DRESS RIGHT (CENTER, LEFT)."** At the command **"DRESS RIGHT,"** the platoon commander of the base platoon aligns his/her platoon immediately by the commands **"Dress Right, DRESS;" "Ready, FRONT;"** and **"COVER."** After the platoon commander of the base platoon gives the command to dress right, the remaining platoon commanders will align their platoons in successive order. When **"DRESS CENTER"** is given, the commander of the center platoon, which is the base platoon for this movement, aligns the platoon to the center of the company. The base platoon for this movement is the second platoon in both three and four platoon companies. After the base platoon commander has aligned the platoon, the remaining platoon commanders will align their respective platoons on the base platoon by executing **"Dress Right (Left), DRESS;" "Ready, FRONT;"** and **"COVER,"** as explained in paragraph 9009.

2. To align the company when in mass formation at a halt, the company commander commands **"Dress Right (Left), DRESS"** or **"At Close Interval, Dress Right (Left), DRESS;" "Ready, FRONT;"** and **"COVER."**

a. At the command **"Dress Right (Left),"** the platoon commander of the base platoon goes to carry sword if so armed.

b. On the command of execution **"DRESS,"** the platoon commander of the base platoon takes one step forward, executes a right flank, moves to a position 1 pace to the right of the right squad leader, executes another right flank and halts 1 pace to the right of the rank of squad leaders. He/she then executes a right face and verifies the alignment of the squad leaders in the same manner as alignment is verified in paragraph 9009. He/she then verifies the alignment of the rest of the company as described in paragraph 9009. (Note: During parades and ceremonies the platoon commander of the base platoon would normally only check the alignment of the 1st, 5th, 9th and 13th (last) rank.) After verifying the alignment of the last rank the platoon commander marches back to the front of the formation 1 pace past the guide. He/she then executes a left flank and moves, by the most direct route, back to his/her position at the head of his/her platoon. The platoon commander then halts, from the oblique, faces right and goes to order sword. When the platoon commander resumes his/her post, the company commander commands **"Ready, FRONT"** and **"COVER."**

3. To align the company when in extended mass formation at a halt, the company commander commands **"Dress Right (Left), DRESS"** or **"At Close Interval, Dress Right (Left), DRESS;" "Ready, FRONT;"** and **"COVER."** Alignment is verified as described in paragraph 10005.2b, above. Except that all platoon commanders move to verify the alignment of their platoons.

4. To align the company when in column, platoons in column, the command is **"COVER."** At that command, the second and following platoons obtain the proper 4-pace distances between platoons and cover on the files of the leading platoon. Each platoon aligns internally as prescribed in paragraph 9009.

5. To align the company when in column of platoons in line at halt, the company commander commands, **"DRESS RIGHT (LEFT)."** At this command, the leading platoon (which is the base platoon) is immediately aligned by its commander who commands, **"Dress Right (Left), DRESS;" "Ready, FRONT;"** and **"COVER."** After the platoon commander of the base platoon has given the command to align the platoon, the remaining platoon commanders in succession from front to rear give the command to align their platoons. Platoon commanders follow the procedures prescribed in paragraph 9009, and ensure that the guides are covered on the guide of the leading platoon.

10006. BEING IN COLUMN, TO CHANGE DIRECTION

1. Being at a halt or in march while in column, to change direction 90 degrees to the right (left), the company commander orders "**Column Right (Left), MARCH.**" On the preparatory command, platoon commanders give the following supplementary commands: leading platoon commander, "**Column Right (Left);**" and remaining platoon commanders, "**Forward,**" if initiated from a halt ("**Continue to March,**" if initiated while marching). On the company commander's command of execution "**MARCH,**" the leading platoon executes a column right (left). Succeeding platoons march forward, and on the commands of their platoon commanders, execute a column right (left) on the same ground as the leading platoon.
2. To execute a 45-degree change in direction, the execution is the same as above, except the command "**Column Half Right (Left), MARCH**" is used. Platoon commanders give appropriate supplementary commands.
3. For slight changes in direction, on the command of the company commander to "**INCLINE TO THE RIGHT (LEFT),**" the guide of the leading platoon changes direction as commanded. Succeeding platoons march forward and change direction on the same ground as the leading platoon. No supplementary commands are given by the platoon commanders.

10007. BEING IN COLUMN, TO FORM MASS FORMATION

1. Being at a halt in column at close or normal interval, the company commander orders "**Company, Mass Left, MARCH.**" On the preparatory command, platoon commanders give the following supplementary commands: leading platoon commander turns his/her head and eyes to the left and commands "**STAND FAST;**" remaining platoon commanders turn their head and eyes to the left and command "**Column Half Left.**" On the company commander's command of execution "**MARCH,**" the leading platoon stands fast, and the remaining platoons simultaneously execute a column half left. On commands of their platoon commanders, the remaining platoons then execute a column half right so as to move into positions alongside the leading platoon at the appropriate interval. As each platoon commander is about to come on line with the leading rank of the halted element, they turn their head and eyes to the right and command "**Mark Time, MARCH.**" The platoon marks time 4-8 counts to gain cover and alignment and is halted by the platoon commander. This forms the company in mass at the appropriate intervals between all adjacent platoons and files.
2. The company on the march in column at close or normal interval is given the same commands at the halt, except that on the preparatory command the leading platoon commander commands "**Mark Time.**" On the company commander's command of execution "**MARCH,**" the leading platoon marks time 4-8 counts then halts on command of its platoon commander. The commands and movements for the remaining platoons are the same as for executing the movement from a halt.
3. If the company was in column at normal interval, then the company mass is at normal interval (e.g., normal interval between files in the platoons and normal interval between platoons in the company). If the company was in column at close interval, then the company mass is at close interval (e.g., close interval between files in the platoons and close interval between platoons in the company).

4. To form a company mass right use the same commands as in paragraph 10007 substituting left for right and right for left. However, forming a company into a mass right results in the platoons being inverted and should only be done under unusual circumstances.

5. There will be occasions when enlisted personnel form the company in mass as part of a larger formation. When the company officers receive the company the same procedures as in paragraph 10002.2c(2) will be used except, that all key personnel on the command **"TAKE YOUR POST"** will execute the following.

a. The platoon commanders will be at the rear of the formation in reverse order.

b. On the command **"TAKE YOUR POST"** the first sergeant will move by the most direct route around the left of the formation and assume his/her normal positions in the rear of the formation.

c. The guidon will move 3 paces forward to his/her position 1 pace to the left and behind the company commander.

d. The platoon commanders will move to their position in front of their respective first squad leaders by the most direct route. This is done by marching in column around the right of the formation until they are 1 pace from their first squad leader and then take one step in the left oblique, halt in front of the squad leader and on line with the guides and execute a right face.

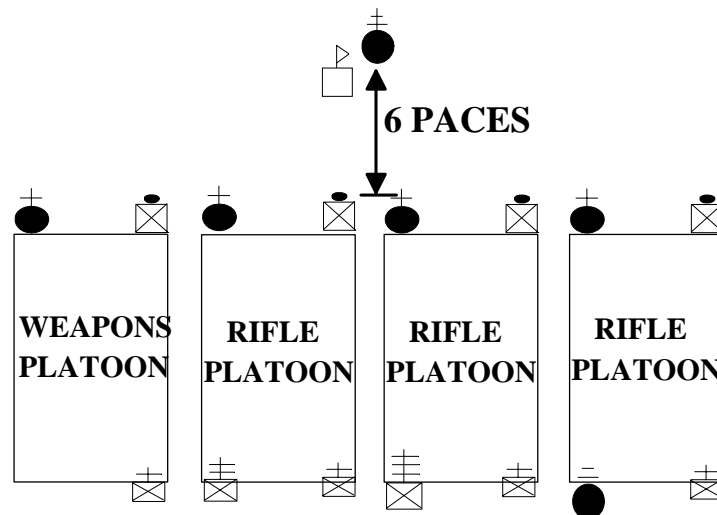

INTERVAL BETWEEN PLATOONS IS THE SAME AS  
THE INTERVAL BETWEEN FILES OF THE PLATOON.

Figure 10-3.--Company Mass Formation.

10008. BEING IN COLUMN, TO FORM EXTENDED MASS FORMATION

1. At a halt or in march while in column, to form extended mass, the company commander orders **"Company Mass (3 to 6) Paces Left, MARCH."** On the preparatory command, platoon commanders give the following supplementary commands: leading platoon commander turns his/her head and eyes to the left and commands **"STAND FAST"** remaining platoon commanders turn their head and eyes to the left and command **"Column Half Left."** On the company commander's command of execution **"MARCH,"** the leading platoon stands fast, and the remaining platoons simultaneously execute a column half left. On commands from their platoon commanders, the remaining platoons then execute a column half right so as to move into positions alongside the leading platoon at the designated (3 to 6-pace) interval. As each platoon commander is about to come on line with the leading rank of the halted element, they turn their head and eyes to the right and command **"Mark Time, MARCH."** The platoon marks time 4-8 counts to gain cover and alignment and is halted by the platoon commander. This formation is used for drills and ceremonies if it is desired to increase the size of the mass in order to present a more impressive appearance. The company in this formation drills in the same manner as for mass formation, maintaining the specified interval between platoons and files in the platoons.
2. The company on the march in column at close or normal interval are given the same commands at the halt, except that on the preparatory command the leading platoon commander commands **"Mark Time."** On the company commander's command of execution **"MARCH,"** the leading platoon marks time 4-8 counts then halts on command of its platoon commander. The commands and movements for the remaining platoons are the same as for executing the movement from a halt.
3. If the company was in column at normal interval, then the company extended mass has normal interval between files in the platoons and the specified (3-6 pace) interval between platoons in the company. If the company was in column at close interval, then the company extended mass has close interval, 4 inches, between files in the platoons and specified (3-6 paces) interval between platoons in the company.
4. To form a company extended mass right use the same commands as in paragraph 10008.1 substituting left for right and right for left. However, forming a company into a mass right results in the platoons being inverted and should only be done under unusual circumstances.
  - e. If the unit is formed at extended mass by enlisted personnel as part of a larger formation the same procedures for posting as in paragraph 10002.2c(2).

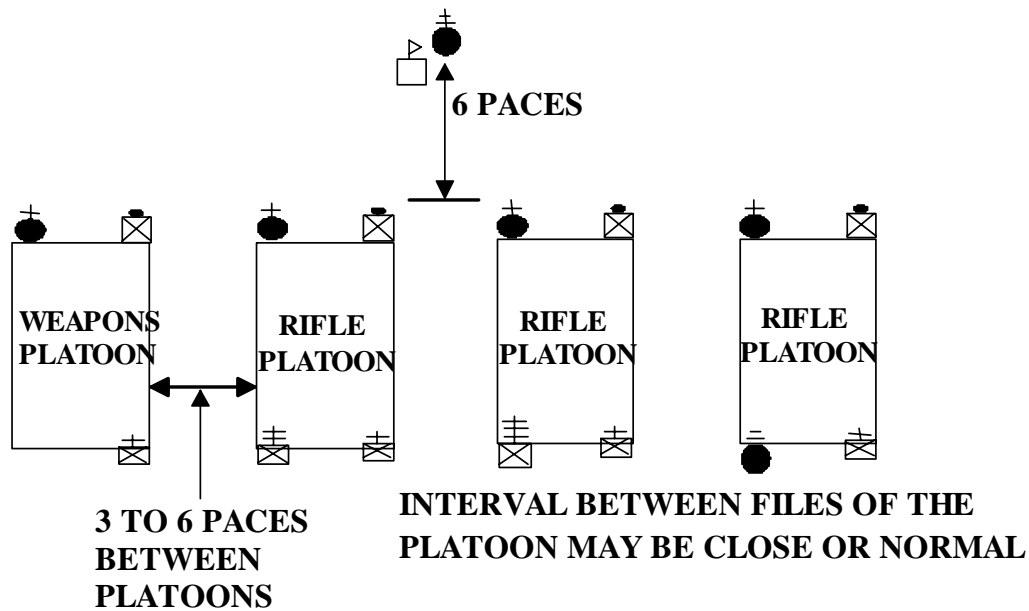

Figure 10-4.--Company in Extended Mass Formation.

10009. BEING IN MASS OR EXTENDED MASS FORMATION, TO CHANGE DIRECTION

1. Being in mass or extended mass formation at a halt or in march, to change direction 90 degrees to the right (left), the company commander commands **"Right (Left) Turn, MARCH"** and **"Forward, MARCH."** The right flank guide of the line of guides and platoon commanders is the pivot for this movement. At the command of execution **"MARCH,"** for the right (left) turn, the pivot faces to the right (left) in marching and takes up the half step. Other members of the first rank execute a right (left) oblique, advance until opposite their place in line, execute a second right (left) oblique, and upon arriving abreast of the pivot man, take up the half step. Each succeeding rank executes the movement on the same ground and in the same manner as the first rank. All take a full step at the command **"Forward, MARCH,"** which is given by the company commander after all members of the company have changed direction and have picked up the half step.

2. Being in mass or extended mass formation at a halt or in march, to change direction 45 degrees to the right (left), the company commander commands **"Half Right (Left) Turn, MARCH"** and **"Forward, MARCH."** This movement is executed in a similar manner for a right turn as described above, except that the pivot makes a half right (left) face in marching, and the members of each rank need execute only one right (left) oblique in marching.

10010. BEING IN MASS OR EXTENDED MASS FORMATION, TO FORM COLUMN

1. Being at a halt in mass or extended mass formation, to form column, the commands are **"Column of Threes (Fours), Right (Left) Platoon, Forward (Column Right), MARCH."** On the preparatory command, the platoon commanders give the following supplementary commands: right (left) platoon commander commands **"Forward (Column Right);"** and the remaining platoon commanders command **"STAND FAST."** On the company commander's command of execution **"MARCH,"** the right (left) platoon marches forward and the remaining platoons stand fast. When the leading platoon

reaches an appropriate point, the next platoon, on commands of its platoon commander, executes necessary column movements so as to take up the march in column at a distance of 4 paces from the leading platoon. Remaining platoons in succession, take up the march in column at distances of 4 paces in a similar manner.

2. Being on the march in mass or extended mass formation, to form a column, the company commander gives the same command as when initiated from a halt. In this case, on the preparatory command, the right (left) platoon commands "**Continue to March (Column Right),**" and the remaining platoon commanders command "**Mark Time.**" On the company commander's command of execution "**MARCH,**" the right (left) platoon continues the march (executes a column right) and the remaining platoons mark time. The platoon commanders of the remaining platoons cause their platoons to execute necessary column movements so as to follow in column behind the leading platoon at a 4-pace distance in a similar manner as when the movement is initiated from a halt.

10011. BEING IN COLUMN, TO FORM COLUMN OF PLATOONS IN LINE

1. Being at a halt and at the order in column, to form column of platoons in line the company commander commands "**Column of Platoons in Line, MARCH**" and "**Left, FACE.**" On the first preparatory command, platoon commanders give the following supplementary commands: leading platoon commander commands "**STAND FAST;**" second platoon commander commands "**Column Right,**" and all other platoon commanders commands "**Forward.**" On the company commander's command of execution "**MARCH,**" the leading platoon stands fast, the second platoon executes a column right and marches 12 paces past the right file of the leading platoon, then, on command of its platoon commander, executes a column left, and marches forward until its front rank is on line with the front rank of the leading platoon (now on its left), marks time 4-8 counts, and halts. Succeeding platoons march forward, executing a column right on the same ground as the leading platoon, then a column left, and finally marking time 4-8 counts and halting on line on commands of their platoon commanders so as to be at 12-pace intervals. When all platoons are halted on line, the company commander commands "**Left, FACE.**" All platoons execute a left face with each platoon commander moving by the most direct route to their post 6 paces front and center of the platoon, and each platoon guide takes post on the right of the front rank of each platoon; the company is then formed in column of platoons in line with 12-pace distances between platoons. The formation may be used for inspections and for the display of equipment.

2. Being on the march in column, to form column of platoons in line, the commands are "**Column of Platoons in Line, Leading Platoon by the Left Flank, MARCH.**" On the preparatory command, platoon commanders give the following supplementary commands: the leading platoon commander commands "**By the Left Flank;**" the remaining platoon commanders command, "**Continue to March.**" Simultaneously, on the preparatory command, all platoon commanders incline to the left from their posts in column and half step so as to be as near as possible to a position 6 paces from and centered on the left file of their platoons prior to the company commander's command of execution "**MARCH.**" At that command, the leading platoon executes a left flank march, its guide moving abreast of the front rank as rapidly as possible; succeeding platoons continue the march forward and, on commands of their platoon commanders, execute a left flank on the same ground and in the same manner as the leading platoon. Each platoon commander, after executing a left flank march, marches at a position 6 paces front and center of the platoon, and the company

commander, guidon bearer, and company staff march in positions. In this formation, which may be used for passing in review during ceremonies, the company marches in column of platoons in line, with the distance between each platoon equal to the length of each platoon plus 4 paces.

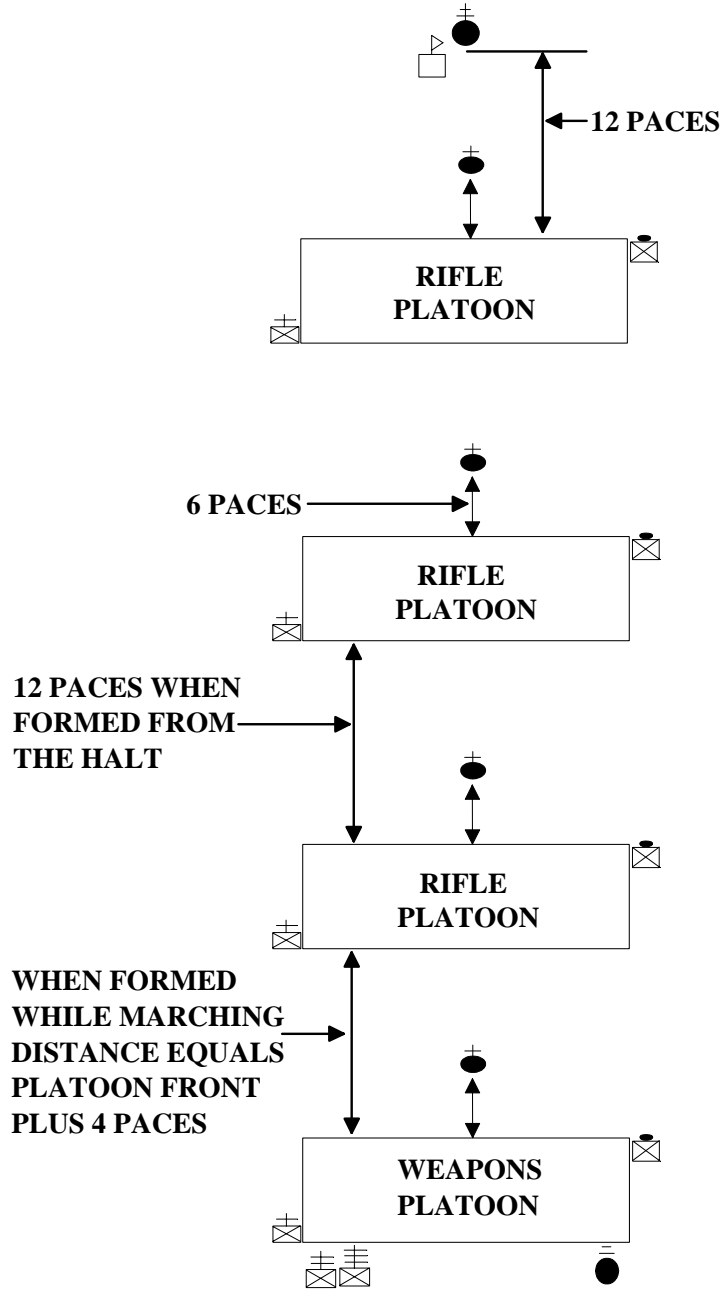

Figure 10-5.--Column of Platoons in Line Formation.



10012. BEING IN COLUMN OF PLATOONS IN LINE, TO FORM COLUMN

1. Being halted at the order in a column of platoons in line, to form column, the company commander commands **"Right, FACE,"** at which time all platoons face to the right with platoon commanders and guides taking posts at the head of the left and right files respectively of their platoons. Next, the company commander orders **"Column of Threes (Fours, etc.), Left Platoon, Forward (Column Left), MARCH."** Thereafter, commands and procedures for executing this movement are the same as prescribed for forming a column from a mass or extended mass formation from the halt in paragraph 10010.

2. While in a column of platoons in line, to form column, the commands are: **"Column of Threes (Fours, etc.), Leading Platoon, By the Right Flank, MARCH"** or **"Column of Threes (Fours, etc.), Leading Platoon by the Right Flank, Column Left, MARCH."** On the preparatory command, platoon commanders give the following supplementary commands: the lead platoon commander commands **"By the Right Flank (By the Right Flank, Column Left);"** remaining platoon commanders command, **"Continue to March."** On the company commander's command of execution **"MARCH,"** the leading platoon executes a right flank (right flank, column left). Succeeding platoons continue to march forward, each, on the command of its platoon commander, executing a right flank (right flank, column left) on the same ground as the leading platoon, then following in trace of the leading platoon in column at 4-pace distances. Officers, key noncommissioned officers, and the company guidon move by the most direct routes to their proper positions in column.

NOTE: In forming column from column of platoons in line at a halt or while marching, movements should always be made in the directions indicated above, otherwise platoons and squads become inverted.

10013. BEING IN COLUMN, TO FORM COLUMN OF TWOS OR FILES AND REFORM

1. Being at a halt in column, to form column of twos (files), the company commander commands **"Column of Twos (Files) from the Right (Left), MARCH."** On the preparatory command, platoon commanders and squad leaders give the following supplementary commands: leading platoon commander commands **"Column of Twos (Files) from the Right (Left),"** after which the squad leaders of the leading platoon give appropriate supplementary commands to form the movement required as prescribed in paragraph 9025; the remaining platoon commanders command **"STAND FAST."** On the company commander's command of execution **"MARCH,"** the leading platoon marches forward in column of twos (files) as prescribed in platoon drill. Succeeding platoons march forward in column of twos (files) on the commands of their platoon commanders and squad leaders in the same manner as the leading platoon so as to follow the leading platoon in column at 4-pace distances.

b. Being at a halt in column of twos (files), to reform column (e.g., column of threes, etc.), the company commander commands **"Column of Threes (Fours, etc.) to the Left (Right), MARCH."** On the preparatory command, the platoon commanders and squad leaders give the following supplementary commands: leading platoon commander commands **"Column of Threes (Fours, etc.) to the Left (Right),"** after which the squad leaders of the leading platoon give appropriate supplementary commands as prescribed in paragraph 9025; the remaining platoon commanders command **"STAND FAST."** On the company commander's command of execution **"MARCH,"** the leading platoon marches forward in column (of threes, etc.) as prescribed in platoon drill. Succeeding platoons march forward in column (of threes) on the commands of their platoon commanders and squad leaders in the same manner as the leading platoon so as to follow the leading platoon in column at 4-pace distances.

10014. COMPANY AWARDS FORMATIONS

1. The ceremonies that are normally conducted at the company level are, but not limited to, the following:

- a. Promotions
- b. Awards
- c. Reenlistments
- d. Special Recognition

2. The company formation normally used for company ceremonies is the Company in Line.

3. The first sergeant forms the company in line with those personnel to receive awards, promotions, etc., forming a single rank behind the last squad of the first platoon. (See figure 10-6.) They are arranged in reverse sequence of presentation priority, to ensure that they are presented to the company commander in the appropriate sequence. (e.g., The junior award recipient would be first in line to march out.) The priority sequence will normally be:

- a. Personal decorations and awards. (e.g., Navy-Marine Corps Achievement Medal, Meritorious Mast, and Letters of Appreciation)
- b. Promotions.
- c. Reenlistments.
- d. Service Awards. (e.g., Good Conduct Medal)
- e. Other certificates (e.g., discharge certificate, MCI completion, etc.)
- f. Retirements if performed on the company level should be a separate ceremony, conducted in the same manner.

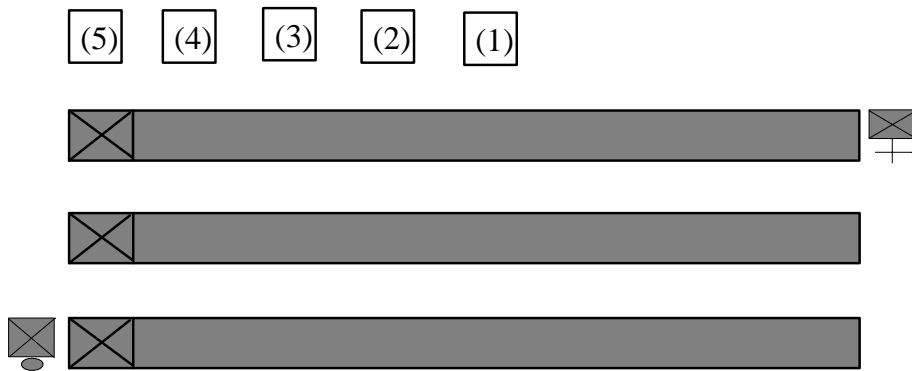

Figure 10-6.--Placing of Award Recipients for the Ceremony.

4. The company is formed as depicted in paragraph 10002. After the first sergeant receives the report from the platoon sergeants he/she faces about and waits for the company commander to take the formation. The first sergeant executes a hand salute and reports the company to the company commander. The company commander returns the salute, and commands **"TAKE YOUR POST."**

→ a. At this command, rather than taking his/her normal post at the rear of the company, the first sergeant will step off in the left oblique and march around the commander's right, and continuing to march until he/she has positioned himself/herself 1 pace to the left and 1 pace to the rear of the company commander. (See figure 10-7.) Platoon commanders take their post centered on their platoons, platoon sergeants post as shown in figure 10-7 and the guidon bearer takes 3 paces forward. For company awards formations, the company guidon bearer will not take 3 steps forward upon the command **"TAKE YOUR POST."**

→ b. The first sergeant will then command **"Persons to be Decorated (be Promoted, Reenlisted, etc.), Front and Center, MARCH."**

→ (1) On the command of **"Front and Center,"** the Marines receiving awards execute a right face.

(2) On the command **"MARCH,"** the award recipients will step off and continue to march until they have cleared the guide of the first platoon. The senior Marine receiving an award will then command **"Column Left, MARCH."** (See figure 10-7.)

(3) They will continue to march to a position that places them at a point half way between the line of platoon commanders and the company commander. The senior Marine will then command **"Column Left, MARCH."**

(4) They will continue to march on this line until the rank of award recipients is centered on the company commander, at which time the senior Marine will command **"Mark Time, MARCH;" "Detail, HALT;" "Right, FACE;"** and **"Hand, SALUTE."** (See figure 10-7.)

c. After the commander has returned the salute, the senior Marine will then command **"Ready, TWO."**

5. The first sergeant or narrator, if one is used, will then read the first citation or warrant. The commander and the first sergeant will then step off and march directly to the first Marine and halt, so the commander is directly in front. The first sergeant will pass the award or warrant to the commander who will then present it to the Marine. After the Marine receives his/her citation the commander and the first sergeant will face to the right as in marching, and march until the commander is in front of the next Marine, halt, and execute a left face. The first sergeant or narrator will read the next citation and the commander will present it. They will continue until the last award or citation is presented. They will then face to the right as in marching, and march in the most direct route to their original positions.

6. Once the company commander and first sergeant are back in position, the first sergeant will then command **"POST."** On the command **"POST,"** the senior Marine will command **"Hand, SALUTE."** The entire detail will execute. After the commander returns the salute, the senior Marine commands **"Ready, TWO"** followed by **"Left, FACE."**

Enclosure (1)

7. The first sergeant then commands **"Forward, MARCH."** On the command of execution **"MARCH,"** the award recipients under the command of the senior Marine will march forward until they are at a position past the platoon sergeant of the last platoon and command **"Column Left, MARCH."** They will continue to march until they are 1 pace past the last rank of the last platoon, the senior Marine will then command **"Column Left, MARCH."** They will continue to march to a position behind the last rank. The senior Marine will then command **"Mark Time, MARCH;" "Detail, HALT;" "Left, FACE."** (See figure 10-7.)

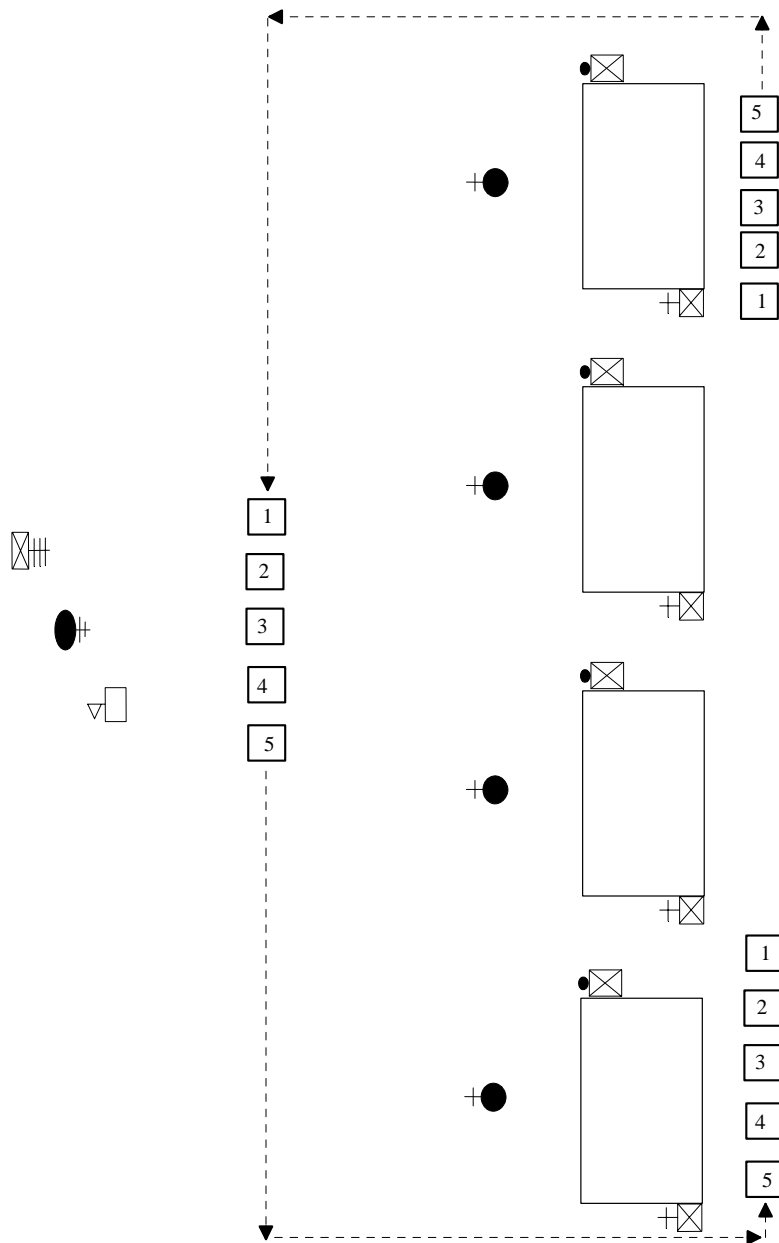

Figure 10-7.--Movements of the Award Recipients.

8. This completes the ceremony. The company commander would then dismiss the company or carries out the plan of the day.

9. When promoting a number of Marines to the same grade, it is appropriate to read only one warrant, inserting all of the names of the Marines being promoted at the appropriate place. However, one warrant is read for each grade being promoted (e.g., one warrant read for the two sergeants, another warrant read for the five corporals, etc.) Additionally, for good conduct medals it is appropriate to read only one citation for all hands receiving the medal, reading the name and number of awards at the appropriate place for all Marines.

MARINE CORPS DRILL AND CEREMONIES MANUAL

PART I: DRILL

CHAPTER 11

BATTALION DRILL

	<u>PARAGRAPH</u>	<u>PAGE</u>
GENERAL . . . . .	11000	11-3
RULES FOR BATTALION DRILL . . . . .	11001	11-4
TO FORM FOR ROUTINE FORMATIONS . . . . .	11002	11-5
TO FORM FOR INSPECTIONS, DRILLS, MARCHES, OR PRIOR TO PARTICIPATION IN LARGER MARCHES OR CEREMONIES . . . . .	11003	11-5
TO FORM IN LINE WITH COMPANIES IN LINE FOR BATTALION FORMATIONS AND CEREMONIES . . . . .	11004	11-6
TO FORM IN LINE WITH COMPANIES IN MASS (EXTENDED MASS) FORMATION FOR BATTALION FORMATIONS AND CEREMONIES . . . . .	11005	11-10
TO FORM BATTALION IN MASS . . . . .	11006	11-13
BATTALION IN COLUMN WITH COMPANIES IN COLUMN . . . . .	11007	11-14
BATTALION IN COLUMN OF COMPANIES WITH COMPANIES IN LINE . . . . .	11008	11-16
TO DISMISS THE BATTALION . . . . .	11009	11-17

FIGURE

11-1	BATTALION IN LINE WITH COMPANIES IN LINE . . . . .	11-6
11-2	GUIDE ON LINE . . . . .	11-7
11-3	PLATOON HALT . . . . .	11-8
11-4	GUIDES POST . . . . .	11-8
11-5	MODIFIED BATTALION IN LINE WITH COMPANIES IN LINE . . . . .	11-9
11-6	BATTALION IN LINE WITH COMPANIES IN MASS FORMATION. . . . .	11-10
11-7	GUIDE OF THE RIGHT PLATOON ON LINE . . . . .	11-10
11-8	FORMING A COMPANY MASS LEFT . . . . .	11-12
11-9	MODIFIED BATTALION IN LINE WITH COMPANIES IN MASS FORMATION . . . . .	11-12
11-10	BATTALION IN MASS FORMATION . . . . .	11-13

MARINE CORPS DRILL AND CEREMONIES MANUAL

	<u>PAGE</u>
11-11    MODIFIED BATTALION IN MASS FORMATION . . . . .	11-14
11-12    BATTALION IN COLUMN OF COMPANIES WITH COMPANIES IN LINE . . . . .	11-15
11-13    BATTALION IN COLUMN WITH COMPANIES IN COLUMN . . . . .	11-16

MARINE CORPS DRILL AND CEREMONIES MANUAL

PART I: DRILL

CHAPTER 11

BATTALION DRILL

11000. GENERAL

1. The formations described in this Chapter pertain to the infantry battalion. Using them as a guide, other units of corresponding size conform as appropriate.
2. Formations used by the battalion are: battalion in line with companies in line; battalion in column (of threes, etc.) with companies in column; battalion in line with companies in mass formation; battalion in mass formation; and battalion in column of companies with companies in line. In all these formations, the platoons that comprise the company will either be in line (each squad forming one rank) or in column (each squad forming one file). The battalion may also form column of twos or files in a manner similar to that prescribed for a company, in which case the companies are arranged as in column, except that each company is in column of twos or files. Formations of the battalion for drill and ceremonies, to include posts of officers and key staff noncommissioned officers, are shown in figures 11-1 through 11-13.
3. When the battalion commander is absent, the senior officer present with the battalion posts and drills the battalion as prescribed for the battalion commander. In the absence of the sergeant major, the senior noncommissioned officer posts and performs the duties of the sergeant major.
4. When officers are not present, after the battalion is formed, the sergeant major, or in his/her absence, the next senior staff noncommissioned officer posts and drills the battalion as prescribed for the battalion commander, and first sergeants posts and perform the duties of the company commanders. This also applies when, for any reason, the battalion commander directs the sergeant major (or senior staff noncommissioned officer) to take charge of the battalion for purposes other than dismissing the battalion. When this occurs, the officers retire and the sergeant major and first sergeants march by the most direct route to take post as the battalion commander and company commanders, respectively.
5. When practicable, the formation and movement of the subdivisions of the battalion should be made clear to subordinate commanders before starting the movement.
6. The battalion drills by command for formations and ceremonies where units of the battalion execute the manual, facings, and marching as one body at the command of execution of the battalion commander. The battalion in a manner similar to that prescribed for the company executes these movements.
7. To assume any formation, the battalion commander indicates the formation desired the point where the right (left) of the battalion is to be, and the direction in which the line or column is to face. Formations should be such that, in approaching the line on which the battalion forms, columns and lines are either perpendicular or parallel to the front.
8. Upon completing the movement ordered by the battalion commander, companies may be given "AT EASE" until another movement is ordered. After a ceremony has started, units remain at attention until ordered to stand at parade rest or at ease by the battalion commander or adjutant.



9. After a battalion is halted, its subdivisions make no movement to correct alignment or position unless so directed by the battalion commander.
10. When the battalion is presented to its commander or to a reviewing officer, the officer who makes the presentation faces the battalion and commands **"Present, ARMS."** When all elements of his/her unit are at present arms, he/she faces the front and salutes. Members of his/her staff salute and terminate the salute with him/her.
11. When the battalion commander does not take the formation, the executive officer (or in his/her absence, the next senior officer) is commander of troops. The commander of troops takes post, gives all commands, and receives all salutes prescribed for the battalion commander.
12. For close-order drill, marches and physical fitness training, the battalion headquarters command group is formed as directed by the battalion commander.
13. During battalion physical training and conditioning marches when the battalion is in column, the sergeant major will move from his/her normal position with the staff and assume a position to the left of the battalion commander. Normally the organizational colors are not carried during physical training or conditioning marches. However, if the battalion commander directs that they be taken they will form immediately to the rear of the battalion commander.

#### 11001. RULES FOR BATTALION DRILL

1. The commands or orders of the battalion commander are given by voice, by bugle, by signal, or by means of staff officers or messengers who communicate them to commanders concerned.
2. Company commanders and platoon commanders give supplementary commands in the same manner as prescribed for company drill (see paragraph 10001).
3. The color guard is posted to the left of the color company when the company is in line and in rear when the company is in column. The color company is posted in the battalion formation so that the color guard is in the approximate center of the formation (right or forward of center, if this is impossible). The color guard may be omitted for daily battalion formations.
4. The adjutant posts the band when present.
5. Attached units take position as directed by the battalion commander and conform to the formation and movements of the battalion.
6. In whatever direction the battalion faces, the companies are designated numerically from right to left in line and from front to rear in column; that is, first company, second company, third company, etc.
7. The terms "right" and "left" apply to actual right and left as the troops face.
8. The designation "center company" indicates the right center or the actual center company, according to whether the number of companies is even or odd.
9. Personnel of the battalion Headquarters and Service Company may be attached to other companies of the battalion for ceremonies.

10. The battalion commander supervises the formation from such positions as will best enable him/her to correct alignments, intervals, and distances. With his/her staff (less the adjutant), he/she takes post in time to receive the report. The position of the staff may be modified during daily battalion formations.

11. For daily battalion formations at which promotions or awards will be effected the procedures for company awards ceremonies may be used (see paragraph 10014).

12. Any formation or combination of formations may be employed to meet existing conditions of space or purpose. Spacing between elements may also be adjusted as necessary.

#### 11002. TO FORM FOR ROUTINE FORMATIONS

1. The following are the standard procedures for forming of the battalion for routine formations using modifications to standard formations as shown in figures 11-5, 11-9, and 11-11. These modified formations are normally used to form the battalion for daily formations for passing the word, promotion or award formations, or prior to battalion physical training and conditioning marches.

a. The companies are formed by their staff noncommissioned officers/noncommissioned officers and/or officers at their designated location as prescribed for company drill (see paragraph 10002.) Company commanders then position their companies in the prescribed formation where the battalion is to form. If the colors are to be carried the color guard and color company first receives the battalion colors (see paragraph 7302), then take their position in formation.

b. The battalion staff will be posted to the right of the lead company as shown in figures 11-5, 11-9, and 11-11 under the command of the battalion executive officer.

c. If the battalion is formed by enlisted personnel the procedures for reporting and posting for company drill (see paragraph 10002) will be used by the sergeant major and first sergeants. The staff will remain at ease until the battalion commander has assumed his/her position and is ready to receive the report from the sergeant major, at which time the staff will come to "ATTENTION."

#### 11003. TO FORM FOR INSPECTIONS, DRILLS, MARCHES, OR PRIOR TO PARTICIPATION IN LARGER MARCHES OR CEREMONIES

1. The following are the standard procedures for a ceremonial forming of the battalion for those formations shown in figures 11-1, 11-6, 11-10, 11-12, and 11-13.

a. At "Assembly" the companies are formed by their staff noncommissioned officers/noncommissioned officers and officers at their designated locations as prescribed for company drill (see paragraph 10002). Company commanders then position their companies in the prescribed formation where the battalion is to form. If the colors are to be carried the color guard and color company first receives the battalion colors (see paragraph 7302), then take their position in formation.

b. The adjutant takes post 6 paces to the right of and facing where the right flank of the battalion will rest when forming in line (or 6 paces in front of and facing the leading guide of the leading company in column) draws sword if so armed, and supervises the positioning of the companies.

- c. If a band or bugler is not present at the time for "*Adjutant's Call*," the adjutant marches by the most direct route to a position midway between the line of company commanders and battalion commander when in line (or midway between the leading company commander and battalion commander in column), faces the battalion, and commands "**Battalion, ATTENTION.**" The adjutant then faces the battalion commander, salutes and reports, "Sir/Ma'am, the battalion is formed." The battalion commander returns the salute and orders "**TAKE YOUR POST.**" The adjutant passes to the battalion commander's right and takes his/her post in the staff. The battalion commander and staff then draw swords, if so armed and execute order sword. Then appropriate commands are given to conduct the inspection, drill, or march (If forming prior to participation in regimental or larger marches or ceremonies, the battalion awaits the second, or regimental "*Adjutant's Call*."
- d. If a band is present, in lieu of bringing the battalion to attention by voice command, the adjutant may direct "**Sound, ATTENTION.**" After "*Attention*" is sounded, the companies are brought to attention in succession from right to left when in line (front to rear in column), but remain at the order. Next, the adjutant orders "**Sound, ADJUTANT'S CALL.**" Companies stand fast while "*Adjutant's Call*" is sounded. The adjutant then takes post midway between the line of company commanders and battalion commander when in line (midway between the drum major and battalion commander when in column) and reports that the battalion is formed.

11004. TO FORM IN LINE WITH COMPANIES IN LINE FOR BATTALION FORMATIONS AND CEREMONIES

1. The following are procedures for the ceremonial forming of a battalion line with companies in line. Figure 11-1 depicts this formation.

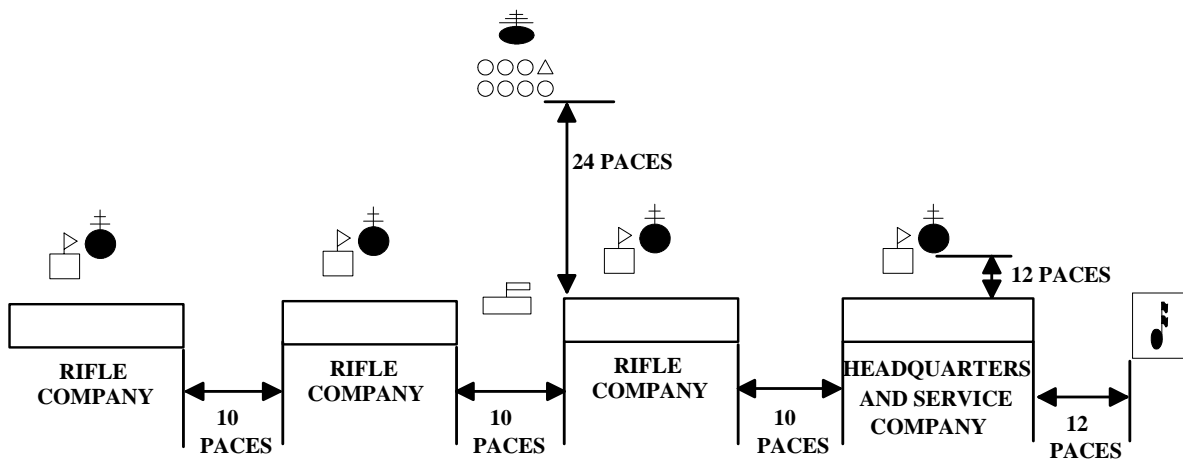

Figure 11-1.—Battalion in Line with Companies in Line.

1. At "*Assembly*" the companies are formed by their staff noncommissioned officers/noncommissioned officers and officers at their designated locations as prescribed in company drill (see paragraph 10002). The color guard and color company, after forming, receives the battalion colors (see paragraph 7302). The companies remain at their locations for assembly, or if directed by the battalion commander, move to positions closer to the battalion parade ground and await "*Adjutant's Call*" to form the battalion for the ceremony.

Enclosure (1)

b. The adjutant indicates the line on which the battalion is to form with two dress guidons on each flank. He/she takes post on the line 6 paces from and facing where the right flank of the battalion will rest, and draws sword if so armed. When the band is present, at the designated time the adjutant orders the band to **"Sound, ATTENTION."** At the sounding of "Attention," the companies are brought to attention and to right shoulder arms from front to rear or from right to left. After the entire battalion is at attention and at right shoulder arms, the adjutant orders the band to **"Sound, ADJUTANT'S CALL."**

c. Companies are marched from the left flank of the parade field in column of threes (or fours) so as to arrive at positions on the line of troops successively from right to left. The command of execution for their movement is so timed that they will step off at the first note of the march following "Adjutant's Call."

(1) As the company commander and guide arrive at a position abreast of their position in formation they execute a left flank, march forward to their positions and halt. The guide goes to order guidon; the company commander faces about towards the company and remains at carry sword, if so armed.

(2) As each platoon approaches its position on the line, the platoon commander orders **"GUIDE ON LINE."** The platoon guide goes to port arms and double times to a position to the left of where the platoon's squad leaders will halt, halts facing the adjutant, and goes to order arms. (See figure 11-2.)

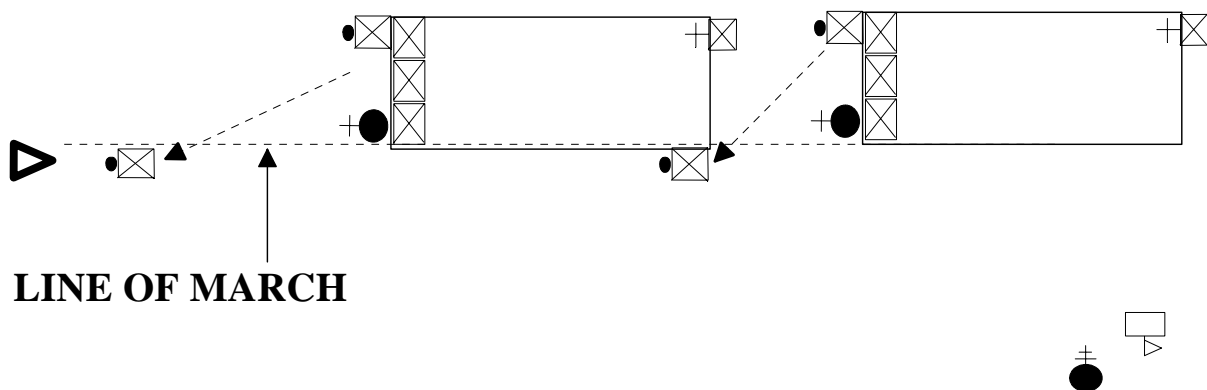

Figure 11-2.--Guide on Line.

(3) The company commander then gives the command **"Mark Time, MARCH"** so that the left squad leaders mark time beside the platoon guides. After 4-8 counts of mark time the company commander gives the command **"Company, HALT."** (See figure 11-3.) Once all platoons are halted the company commander gives the command to **"Order, ARMS;"** however, the platoon commander and platoon sergeant remain at carry sword, if so armed. The company commander then commands, **"Left, FACE."** The platoons, except for the guides, face to the left. Platoon sergeants go to order sword, if so armed. Platoon commanders, after facing left move to their position 6 paces in front of and centered on the platoon, halts from the oblique, with the platoon to his/her rear, and goes to order sword.

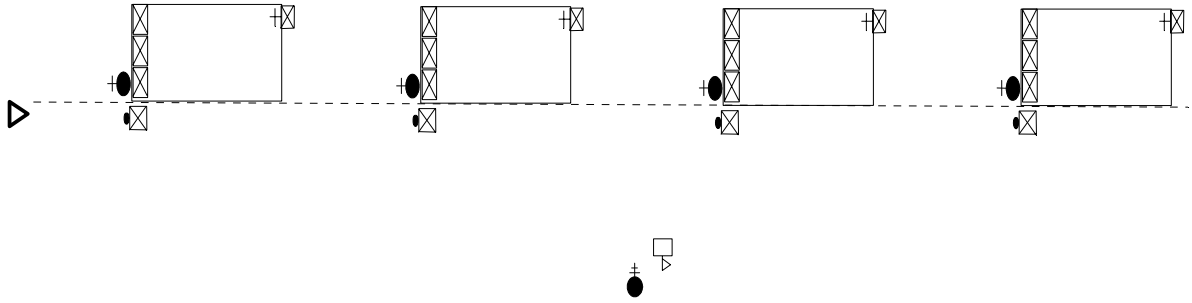

Figure 11-3.--Platoon Halt.

(4) When all platoon commanders are in position and at order sword the company commander commands "**DRESS RIGHT.**" Platoon commanders go to carry sword, face their platoons, and in sequence from right to left, command, "**Dress Right, DRESS.**" The platoons are aligned as indicated in paragraph 9009. When the platoon commanders have finished aligning their platoons they command "**Ready, FRONT**" and "**COVER,**" move back to their positions 6 paces and centered on their platoons, halt from the oblique, with the platoon to his/her rear, and goes to order sword. The company commander faces about and goes to order sword, if so armed.

d. On the command of "**FRONT,**" by the first platoon commander in the line the adjutant moves by the most direct route to a position midway between the line of company commanders and the battalion commander and faces the battalion. After all units have finished dressing right, the adjutant commands "**Guides, POST.**" At the command "**POST,**" the guides move to their normal positions in ranks. To do this, the guides take one step forward, then take one step to the right, halts and execute an about face. (See figure 11-4.) If prescribed for the ceremony, the adjutant next commands "**Fix, BAYONETS.**" After fixing bayonets, or after posting the guide if bayonets are not fixed the ceremony proceeds as for a parade in chapter 15, a review in chapter 16, or for any formation as appropriate.

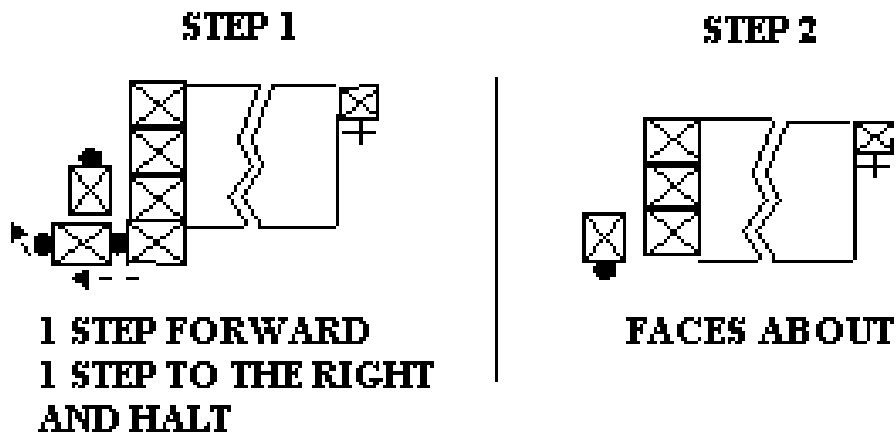

Figure 11-4.--Guides Post.

e. In the case of well-drilled and rehearsed troops, executing the movement **"GUIDE ON LINE"** and **"Guides, POST"** may be deleted. The formation would march to position on the line of troop, mark time, halt, face left, order arms and dress right.

f. If space or circumstances require, after forming at "Assembly," the companies may be directed to take their positions on the line of troops prior to "Adjutant's Call". In this case, procedures are as described above, except when "Attention" is sounded companies remain at order arms after being brought to attention, and at "Adjutant's Call" the companies stand fast (guides are not put on line). The adjutant then marches from the right of the line to his/her post front and center of, and facing the battalion. He/she causes the companies to dress to the right, fix bayonets (if prescribed), and the ceremony to proceed according to the type being conducted.

2. Figure 11-5 depicts modifications to the standard formation battalion in line with companies in line. The following procedures apply.

a. March on is normally omitted and the battalion forms by companies at a pre-designated location.

b. Enlisted personnel normally form the formation.

c. The staff forms to the right of the first company under the command of the battalion executive officer. The adjutant remains with the staff.

d. The color guard may be omitted.

e. Spacing and positioning of companies may be adjusted by the battalion commander to fit existing space or conditions.

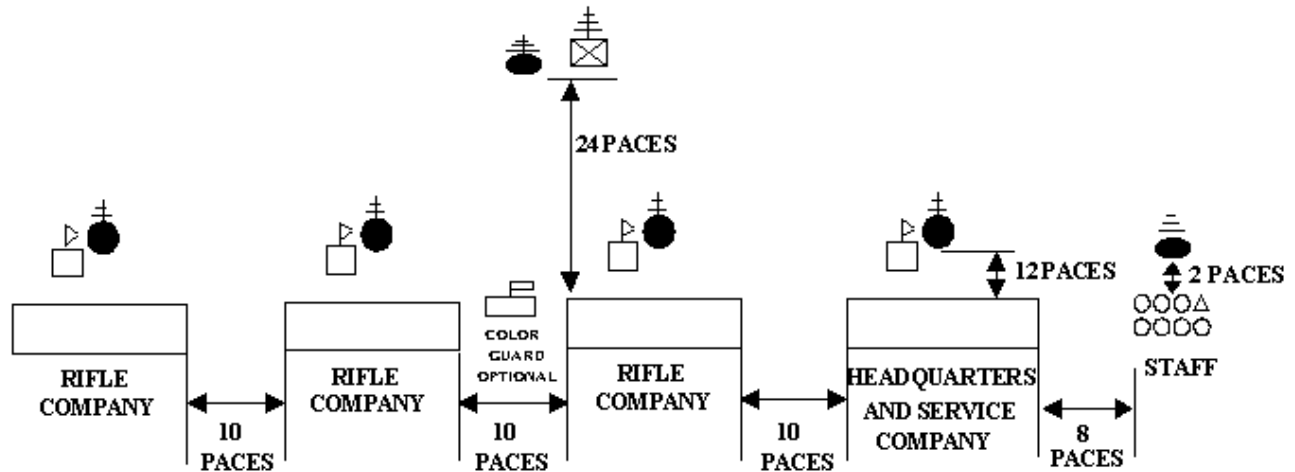

Figure 11-5.--Modified Battalion in Line with Companies in Line.

11005. TO FORM IN LINE WITH COMPANIES IN MASS (EXTENDED MASS) FORMATION FOR BATTALION FORMATIONS AND CEREMONIES

1. Figure 11-6 depicts battalion in line with companies in mass formation. For the ceremonial forming the procedure is the same as in forming in line except that when marching on at "Adjutant's Call."

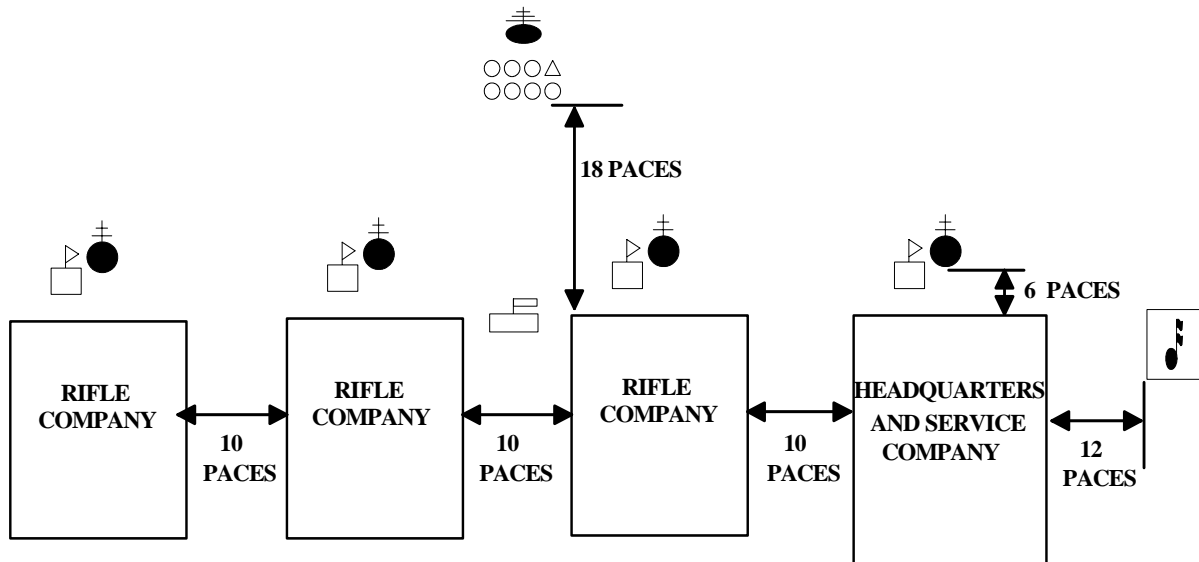

Figure 11-6.--Battalion in Line with Companies in Mass Formation.

a. Companies are marched from either flank in mass formation to their positions in line, the line of march being well in rear of the line on which the battalion is to form. When opposite its place in line, each company executes "Left (Right) Turn, MARCH." As soon as this turn has been initiated, the company commander commands "GUIDE OF RIGHT PLATOON ON LINE." At this command, the guide of the right platoon moves out at double time (at port arms) to the line indicated by the dress guidons, halts, goes to order arms, and faces the adjutant. (See figure 11-7) The guide indicates the right of the company.

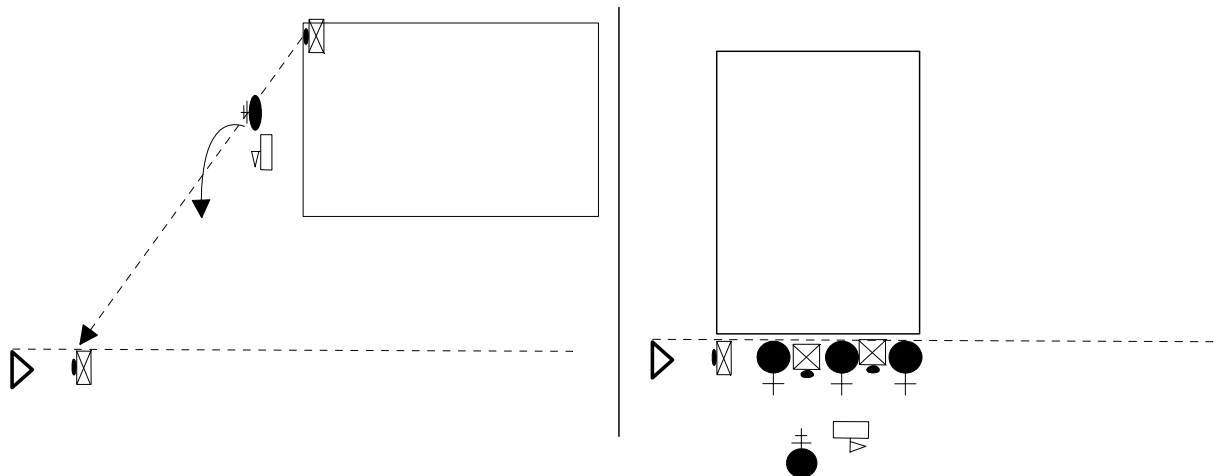

Figure 11-7.--Guide of the Right Platoon on Line.

b. The company continues to march forward towards the line of troops. When approaching the company's position the company commander commands **"Mark Time, MARCH."** The company marks time 4-8 steps to obtain cover and alignment. The right squad leader marks time so as his/her chest is lightly touching the right elbow of the guide. The company commander and guide, after reaching their position, halt. The guide goes to order guidon. The company commander faces the company and gives the command **"Company, HALT."** The company commander while facing the company and commands **"Order, ARMS"** and **"Dress Right (At Close Interval, Dress Right), DRESS."** The first platoon commander aligns the company as described in paragraph 10005. When the platoon commander is back in position and at order sword, if so armed, the company commander commands **"Ready, FRONT"** and **"COVER."** The company commander then faces about and goes to order sword, if so armed.

c. On the command of **"FRONT,"** by the first company commander in line the adjutant moves by the most direct route to a position midway between the line of company commanders and the battalion commander and faces the battalion. After all units have finished dressing right, the adjutant commands **"Guides, POST."** At the command **"POST,"** the guides move to their normal positions in ranks. To do this, the guides take one step to the left, in marching, and halt at order arms.

2. Companies may be marched to positions in column of threes (or fours) instead of in mass formation as above. The procedure is the same as above except that:

a. When the company commander and guide come abreast of the right flank of where the company will come to rest in the line of troops the company commander commands **"Column Left, MARCH."** The company commander, guide and leading platoon execute the column left. As soon as the column movement has been initiated, the company commander orders **"GUIDE OF LEADING PLATOON ON LINE."** The guide moves out to his/her position on the line as described in 11004.1. The company commander then commands, **"Company Mass Left (Company Mass 3-6 Paces Left), MARCH."**

(1) The lead platoon commander as he/she approaches the guide, gives the command **"Mark Time, MARCH."** The right squad leader marks time so as his/her chest is lightly touching the right elbow of the guide. The remaining platoons, when abreast of their position, successively execute a column left and move into position on the left of the leading platoon at the designated interval and mark time at the command of their platoon commander. (See figure 11-8.)

(2) The company commander and guide oblique to their positions and halt, facing front. The guide goes to order guidon and remains at attention. The company commander faces the company. When all platoons are marking time the company commander commands **"Company, HALT;" "Order, ARMS;"** and **"Dress Right (At Close Interval, Dress Right), DRESS"** as described in paragraph 10005. After the company is dressed and the platoon commander is back in position the company commander commands, **"Ready, FRONT"** and **"COVER."**

b. On the command of **"FRONT,"** by the first company commander in line the adjutant moves by the most direct route to a position midway between the line of company commanders and the battalion commander and faces the battalion. After all units have finished dressing right, the adjutant commands **"Guides, POST."** At the command **"POST,"** the guides move to their normal positions in ranks. To do this, the guides take one step to the left, in marching, and halt at order arms.



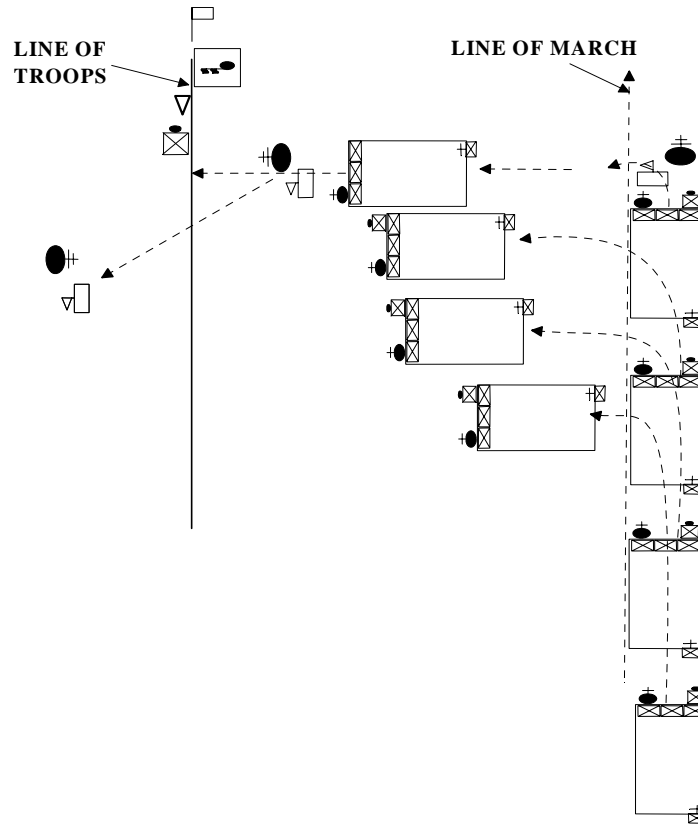

Figure 11-8.--Forming a Company Mass Left.

3. The following figure 11-9 depicts modifications to the standard formation battalion in line with companies in mass formations. The procedures and rules in paragraph 11005 apply to this modification of the standard formation.

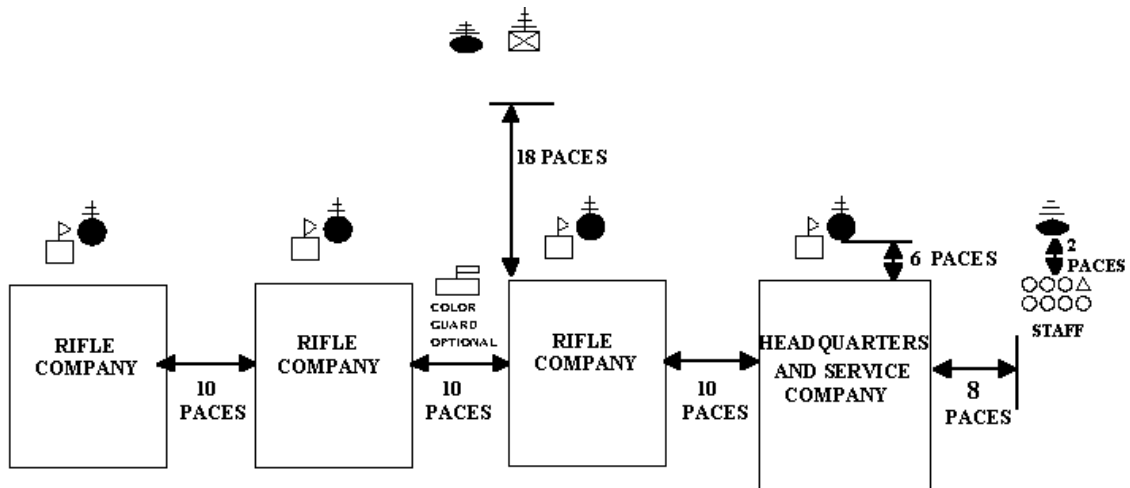

Figure 11-9.--Modified Battalion in Line with Companies in Mass Formation.

11006. TO FORM BATTALION IN MASS

1. The procedure is the same as in forming in line except that companies are marched from either flank in company mass formation at close or normal interval, the line of march being well in rear of the line on which the battalion is to form. When opposite its place in line, each company commander executes left (right) turn. As soon as the turning movement has been initiated, the company commander commands **"GUIDE OF LEADING PLATOON ON LINE."** The guide moves out at double time (at port arms), and takes his/her position on the line of troops as described in paragraph 11004.1. The company then marks time to gain cover and alignment and is halted so that there is appropriate interval (normal or close) between companies. The company is given order arms and the guide, without command, takes his/her post by taking one step to the left, in marching, and halts at order arms. The color guard, depending on the ceremony forms either 6 paces behind the staff or if the battalion is part of a regimental or larger formation is omitted. Figure 11-10 depicts the standard formation.

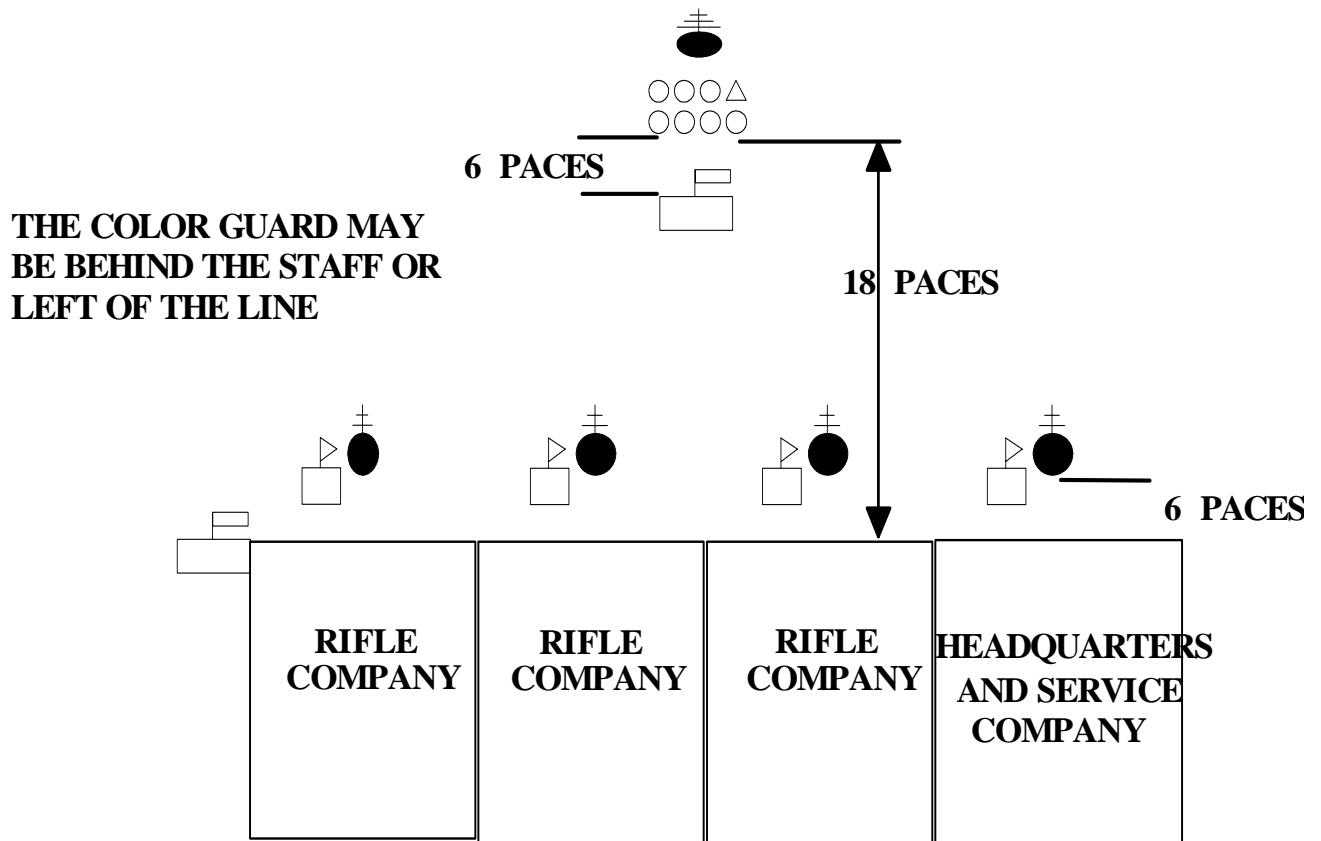

Figure 11-10.--Battalion in Mass Formation.

2. Figure 11-11 depicts the modified version of the battalion mass formation. The procedures and rules that apply in paragraph 11005 apply to this modified formation also.

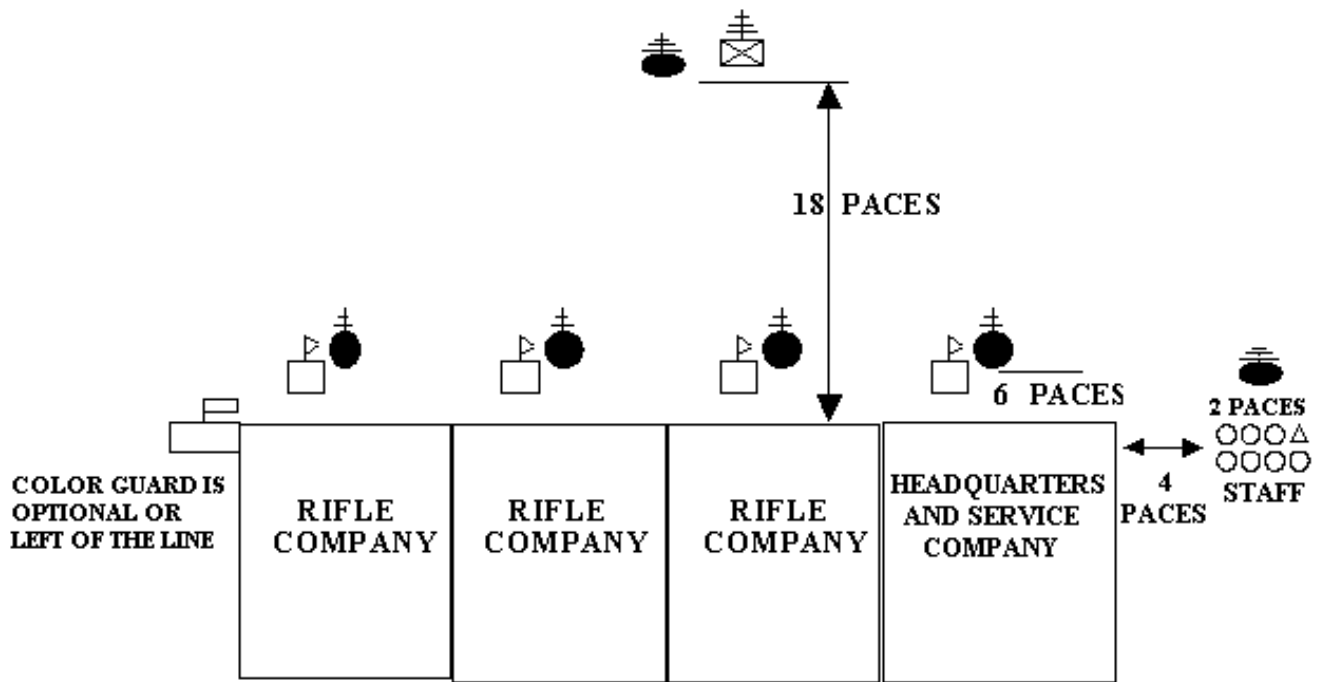

Figure 11-11.--Modified Battalion in Mass Formation.

11007. BATTALION IN COLUMN WITH COMPANIES IN COLUMN. This formation is used to move the battalion from one point to another as a whole unit. It can be used for forming in an assembly area prior to the march on during a ceremony, for battalion movement, for physical training and as the battalion commander may direct. The companies form either in mass or company column. Figure 11-12 depicts this formation.

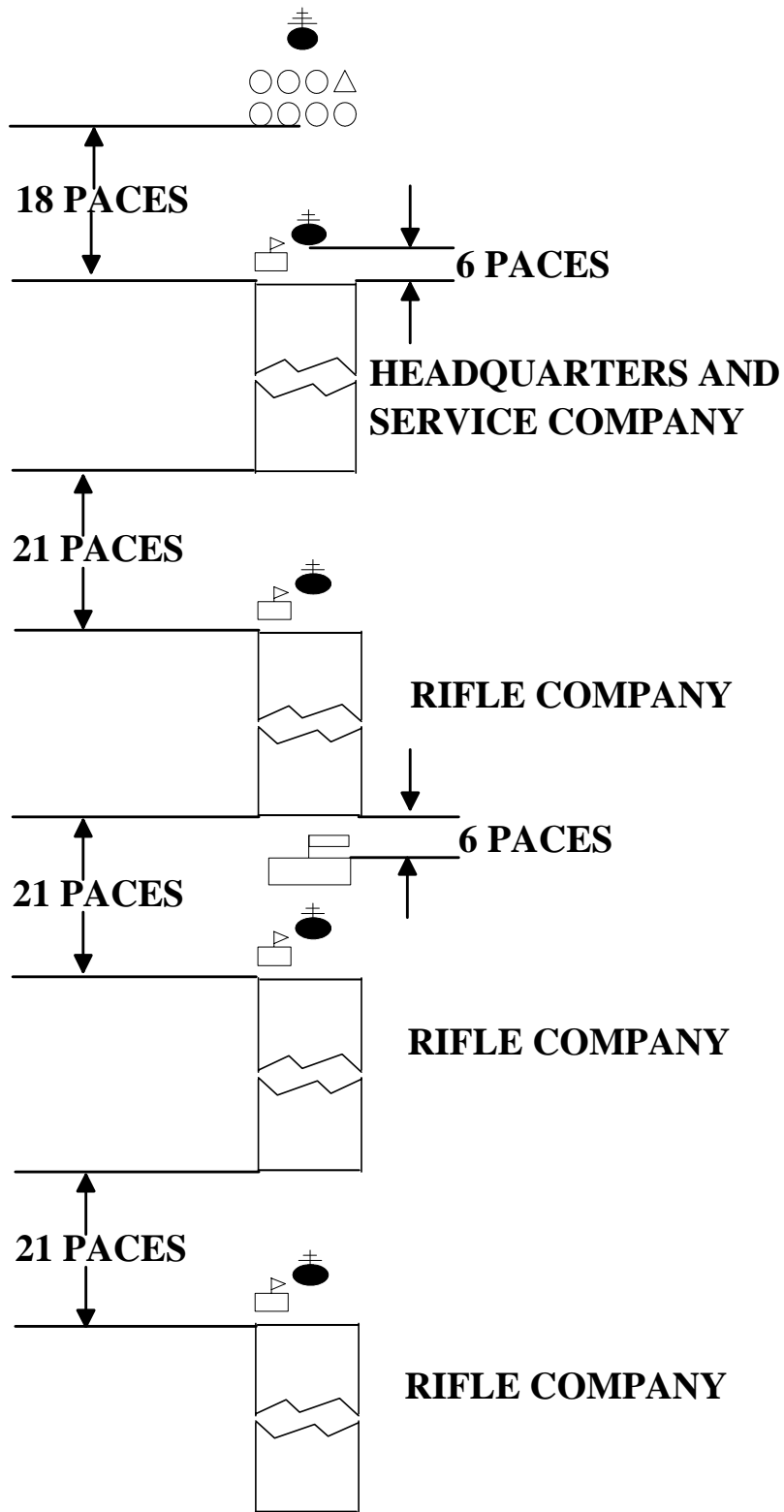

Figure 11-12.-- Battalion in Column of Companies with Companies in Line.

11008. BATTALION IN COLUMN OF COMPANIES WITH COMPANIES IN LINE. This formation is used for either a large review, ceremony or for inspecting a unit. It is formed as depicted in figure 11-13.

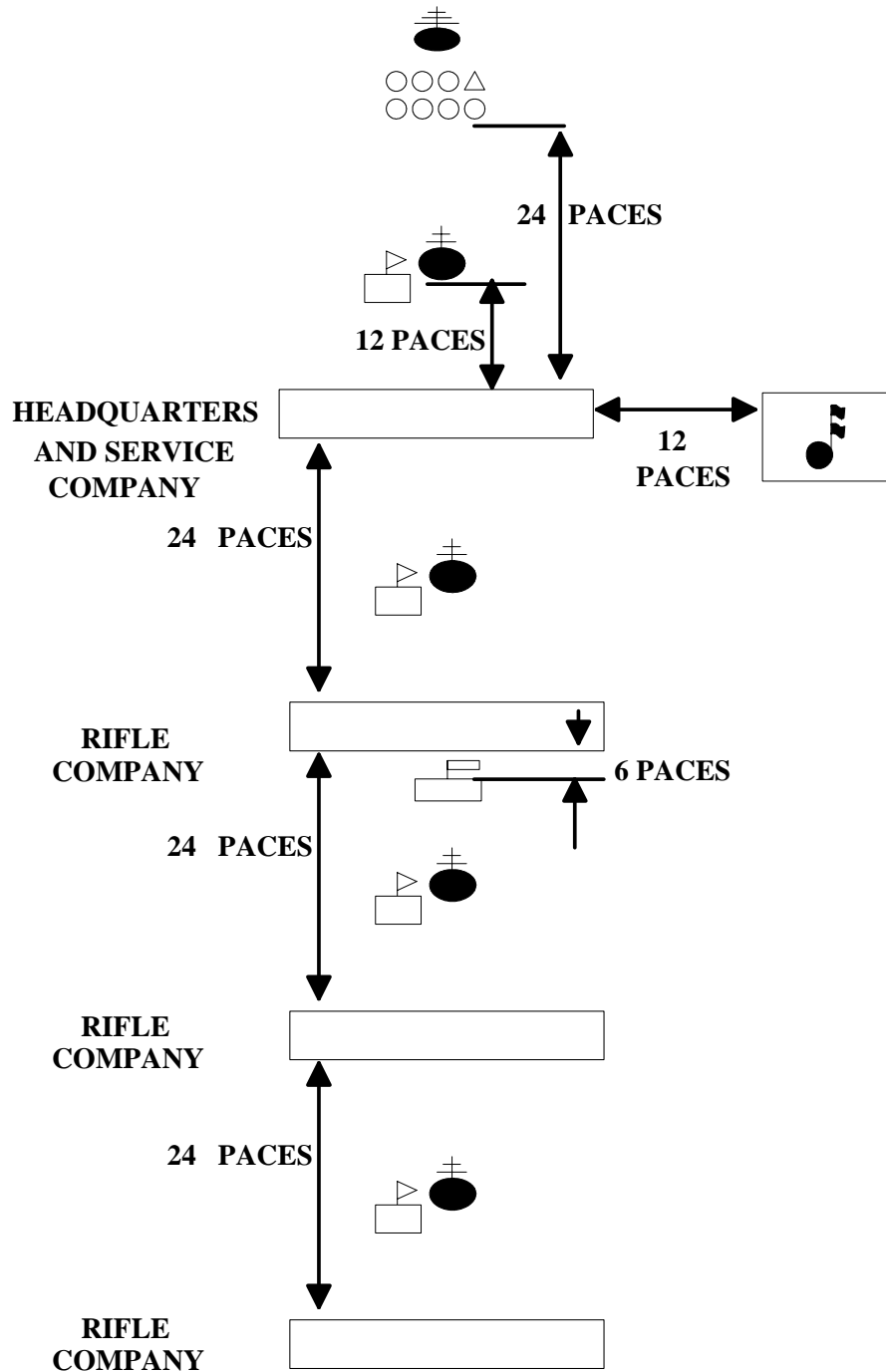

Figure 11-13.--Battalion in Column with Companies in Column.

11009. TO DISMISS THE BATTALION

1. The battalion commander commands "**DISMISS YOUR COMPANIES.**" At this command, each company commander salutes the battalion commander. He/she returns the salutes. Each company commander marches his/her company to the place for dismissal and dismisses it as prescribed in paragraph 10003. If colors were carried, the color company or color guard first returns the colors per paragraph 7304.
2. The companies having marched off, the battalion commander dismisses his/her staff. In modified formations the executive officer would take charge and dismiss the staff.
3. In case the battalion commander desires to release companies to their commanders, without prescribing that the companies promptly be dismissed, he/she commands "**TAKE CHARGE OF YOUR COMPANIES.**" Company commander's salute and the battalion commander returns the salute. The company commanders then take charge of their companies.
4. If the battalion commander turns the battalion over to the sergeant major for dismissal during modified formations then the procedures for dismissal in paragraph 10003 will be followed.

MARINE CORPS DRILL AND CEREMONIES MANUAL

PART I: DRILL

CHAPTER 12

REGIMENTAL DRILL

	<u>PARAGRAPH</u>	<u>PAGE</u>
GENERAL . . . . .	12000	12-3
COMMANDS AND ORDERS . . . . .	12001	12-3
FORMATIONS . . . . .	12002	12-4
TO FORM THE REGIMENT . . . . .	12003	12-4
TO DISMISS THE REGIMENT . . . . .	12004	12-10

FIGURE

12-1	POSITION OF REGIMENTAL AND BATTALION ADJUTANTS . . .	12-5
12-2	FORMING THE REGIMENT . . . . .	12-6
12-3	REGIMENT IN COLUMN WITH BATTALIONS IN COLUMN; COMPANIES IN MASS . . . . .	12-7
12-4	REGIMENT IN COLUMN WITH BATTALIONS IN MASS FORMATION	12-8
12-5	REGIMENT IN LINE WITH BATTALIONS IN MASS FORMATION	12-8
12-6	REGIMENT IN LINE WITH BATTALIONS IN LINE, COMPANY MASS FORMATION . . . . .	12-9





MARINE CORPS DRILL AND CEREMONIES MANUAL

PART I: DRILL

CHAPTER 12

REGIMENTAL DRILL

12000. GENERAL

1. The formations described in this Chapter pertain to the infantry regiment. Using them as a guide, other units of corresponding or larger size conform as appropriate.
2. Subordinate battalions and independent companies will assemble with the regimental color guard, staff, and commander to form the regiment.
3. Subordinate battalions will retain all members of their unit, except for their color guard, when formed with the regiment.
4. The regiment does not drill by command. Its battalions form and march as directed by the regimental commander. When practicable, the formation and movement of the subdivisions of the regiment should be made clear to subordinate commanders before starting the movement.
5. The regimental commander prescribes the formation, the uniform, individual and unit equipment, the place where the regiment is to form, the direction in which it will face, the hour of forming, location of the head of column (or right of the line), and the order in column or line of the headquarters, band, battalions, special and attached units, and trains.
6. Before the regiment is formed, the regimental commander may cause the positions that are to be taken by the larger elements to be indicated by markers.
7. Upon completing a movement ordered by the regimental commander, battalions and independent companies may be given "**REST**" until another movement is ordered. After a ceremony has started, however, units remain at attention until ordered to stand at parade rest or at ease by the regimental commander, adjutant, or commander of troops.
8. Prior to forming the regiment for any purpose, at the locations designated, each independent company forms at "Assembly" (see paragraph 1002), and each battalion forms without its colors at the first, or its own, "Adjutant's Call" (see paragraph 1103). The color guard and color battalion, after forming, receives the regimental colors (see paragraph 7302) prior to ceremonies or other prescribed occasions. All units then wait for the second or regimental "Adjutant's Call" to form the regiment.

12001. COMMANDS AND ORDERS

1. The regimental commander gives his/her commands by voice, by bugle, by signal, or in writing. They may be given directly to the officers concerned or communicated to them through his/her staff.
2. When the regimental commander, adjutant or commander of troops gives commands for drill movements to be executed by the troops, the command is given as a combined command in a voice just loud enough to be distinctly heard by

subordinate commanders so as not to cause premature execution by the troops. Subordinate battalion and independent company commanders, in succession from right to left in line, or front to rear in column, then face their command and give the necessary preparatory command and command of execution to cause the movement to be executed by their troops. For example, the regimental adjutant orders "**PRESENT ARMS**" in a manner that does not demand execution by the troops. Each subordinate commander then goes to carry sword if so armed, faces his/her command and commands "**Present, ARMS,**" the commander then faces back to the front and commands "**Staff, Present, SWORD (ARMS).**" When the adjutant commands "**ORDER ARMS,**" the subordinate commanders command "**Staff, Order, SWORD (ARMS).**" They would then face their command and command the troops to "**Order, ARMS,**" and then face back to the front and go to order sword if so armed.

3. For example, after the adjutant has presented the regiment to the regimental commander, the normal sequence of events would call for the manual of arms to be performed. The regimental commander would command "**ORDER ARMS.**" Subordinate commanders command "**Staff, Order, SWORD (ARMS).**" They would then face their command and command the troops to "**Order, ARMS.**" **The manual arms will then be executed in sequence as shown below with each battalion commander facing about after each command.**

The Regimental Commander  
Commands:

Subordinate Commanders (in succession)  
Command :

**"PORT ARMS"**

**"Port, ARMS"**

**"RIGHT SHOULDER ARMS"**

**"Right Shoulder, ARMS"**

**"PORT ARMS"**

**"Port, ARMS"**

**"LEFT SHOULDER ARMS"**

**"Left Shoulder, ARMS"**

**"PORT ARMS"**

**"Port, ARMS"**

**"ORDER ARMS"**

**"Order, ARMS"**

#### 12002. FORMATIONS

1. For formations of the regiment see figures 12-2 through 12-5.

2. The color guard is posted to the left of the color battalion when the regiment is in line and to the rear of the color battalion when the regiment is in column. The color battalion is posted in the regimental formation so that the color guard is in the approximate center of the formation (right or forward of center, if exact center is impossible).

#### 12003. TO FORM THE REGIMENT

1. To form for regimental ceremonies the procedures described for forming battalions in line in paragraphs 11004 and 11005, or battalions in mass formation in paragraph 11006 are followed, except as indicated below:

a. Prior to the start of the ceremony, the battalion adjutants take their posts behind the line of march and abreast of their position in the line of troops, draw swords if so armed, and go to parade rest. The regimental adjutant, when directed by the regimental commander or commander of troops, moves to his/her position in the line of troops, (8 paces to the right of where the right flank of the regiment will rest) faces down the line, and draws sword if so armed. The regimental adjutant then commands "**Sound, ATTENTION.**" The band plays "*Attention,*" and the battalion adjutants go to attention and carry sword.

The regimental adjutant then commands "**Sound, ADJUTANT'S CALL.**" On the first note of the music after "*Adjutant's Call*," the battalion adjutants march forward to their position in the line of troops (6 paces to the right of where the right flank of their battalions will rest), face down the line, and remain at attention and carry sword if so armed. (See figure 12-1.)

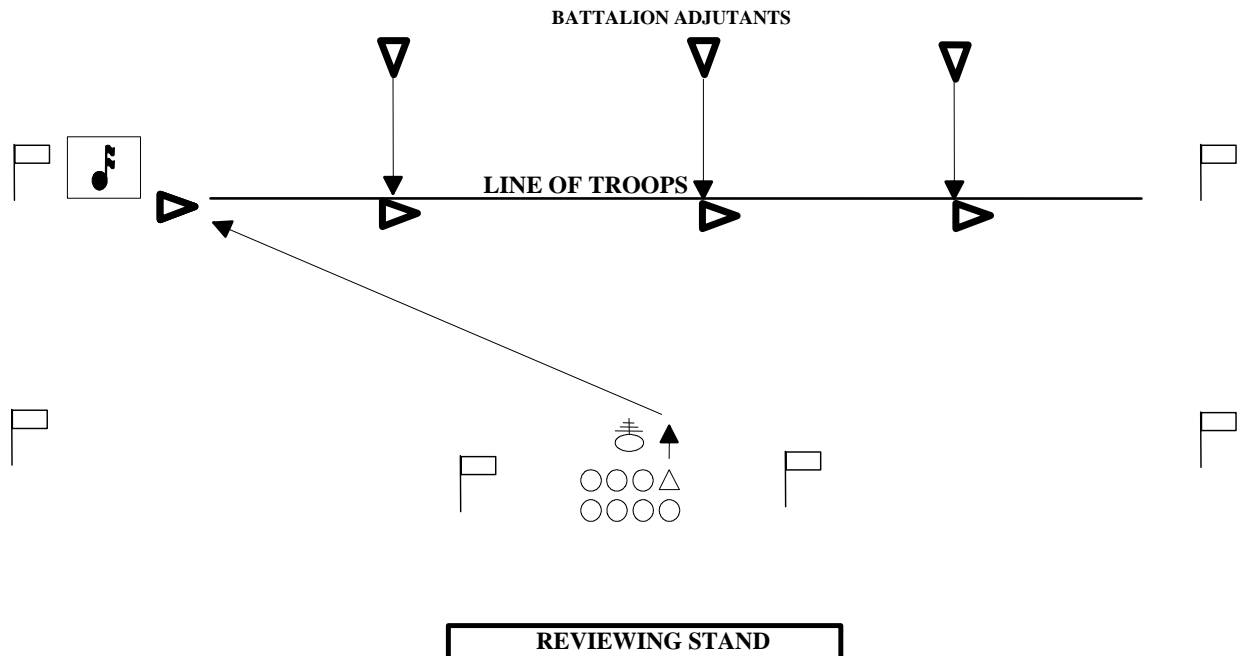

Figure 12-1.--Position of Regimental and Battalion Adjutants.

b. After the lead element of the regiment has completed dressing to the right and on the command of execution "**FRONT,**" from its commander, the regimental adjutant moves to his/her position centered on the formation and midway between the line of battalion commanders and the regimental commander, and faces the regiment remaining at attention and carry sword if so armed. After the lead element of their battalion has completed dressing to the right and on the command of execution "**FRONT,**" from its commander, the battalion adjutants return to their position in the battalion staff, and go to order sword if so armed. Once all elements of the regiment have completed dressing to the right and the battalion adjutants are back in their respective staff, the regimental adjutant commands "**Guides, POST,**" (if the units were marched on) and "**FIX BAYONETS**" (if prescribed). The ceremony would then proceed per chapters 15 through 20.

2. To form for marches, or prior to participation in a larger unit ceremony, the regiment forms at its designated location at regimental "*Adjutant's Call*" (which may be by voice command or by music) according to the same procedures set forth for a battalion in paragraph 11003, except commanders of battalions and independent companies report their arrival in the regimental formation to the regimental adjutant. Figure 12-2 depicts a regiment formed for a parade or review.

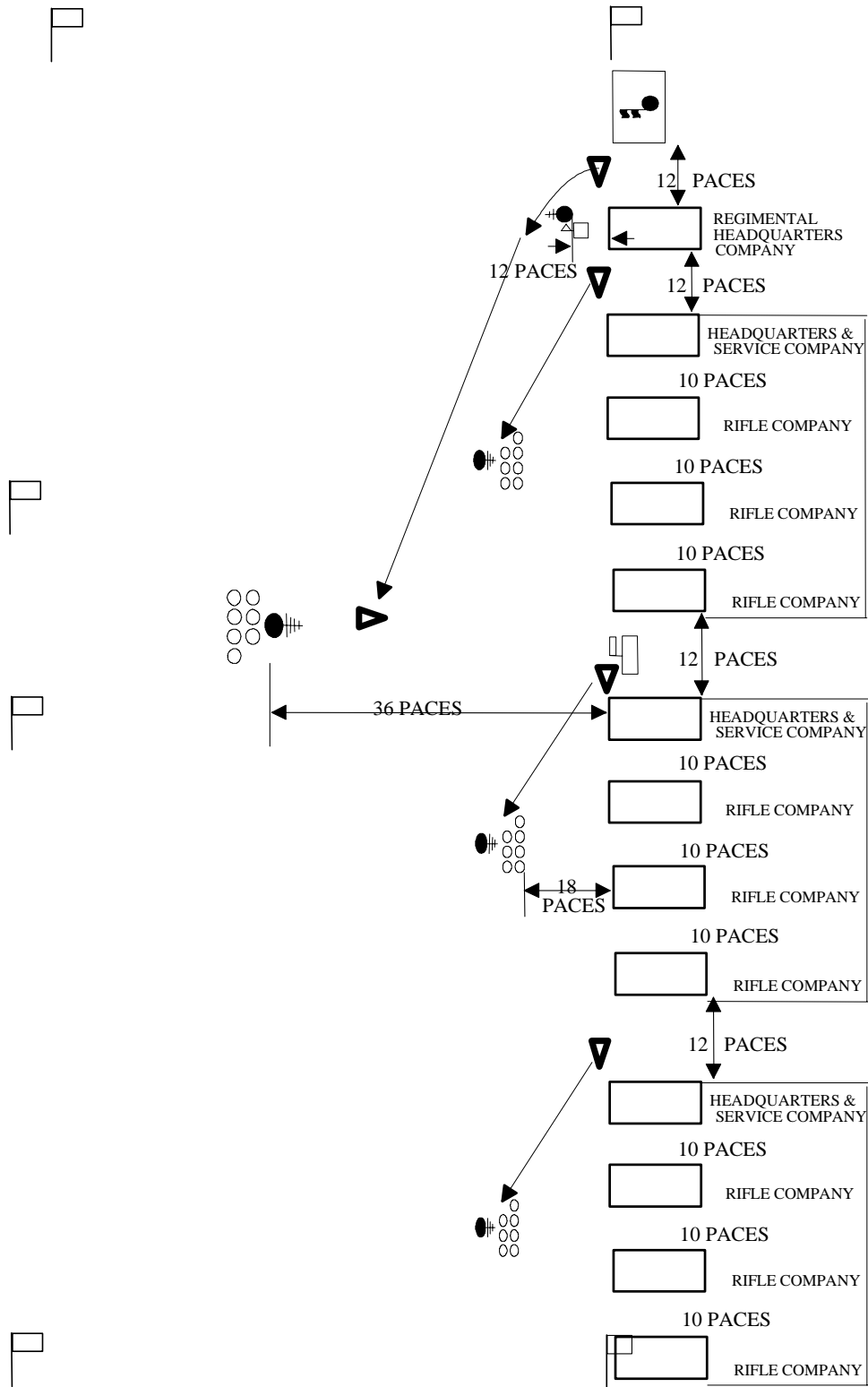

Figure 12-2.--Forming the Regiment.

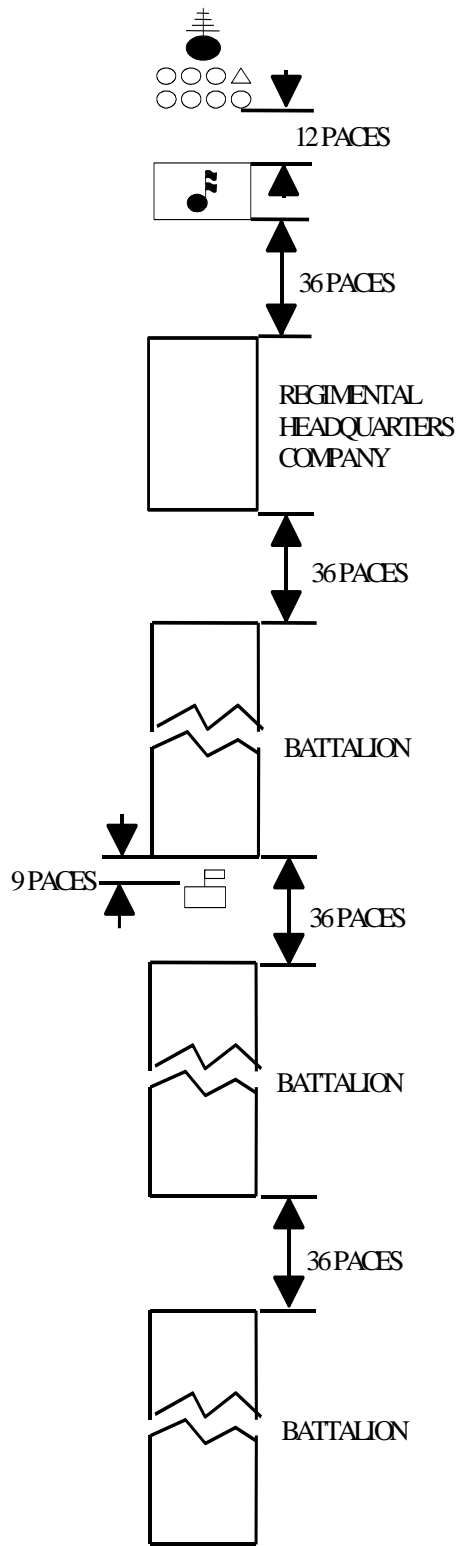

Figure 12-3.--Regiment in Column with Battalions in Column; Companies in Mass.

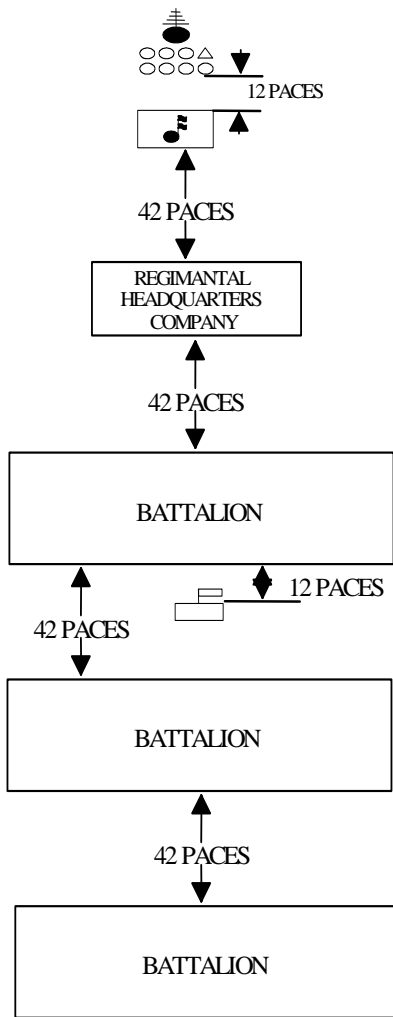

Figure 12-4.--Regiment in Column with Battalions in Mass Formation.

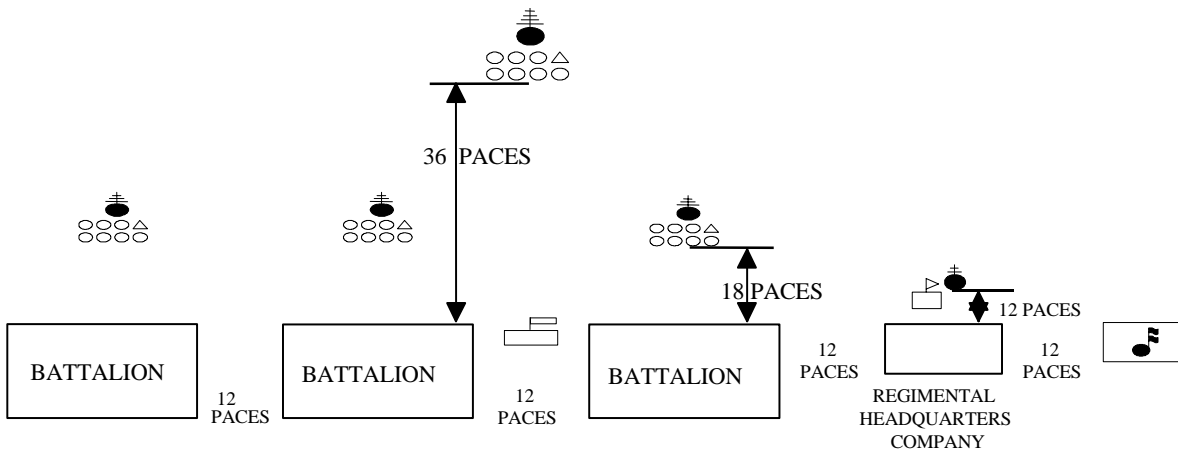

Figure 12-5.--Regiment in Line with Battalions in Mass Formation.

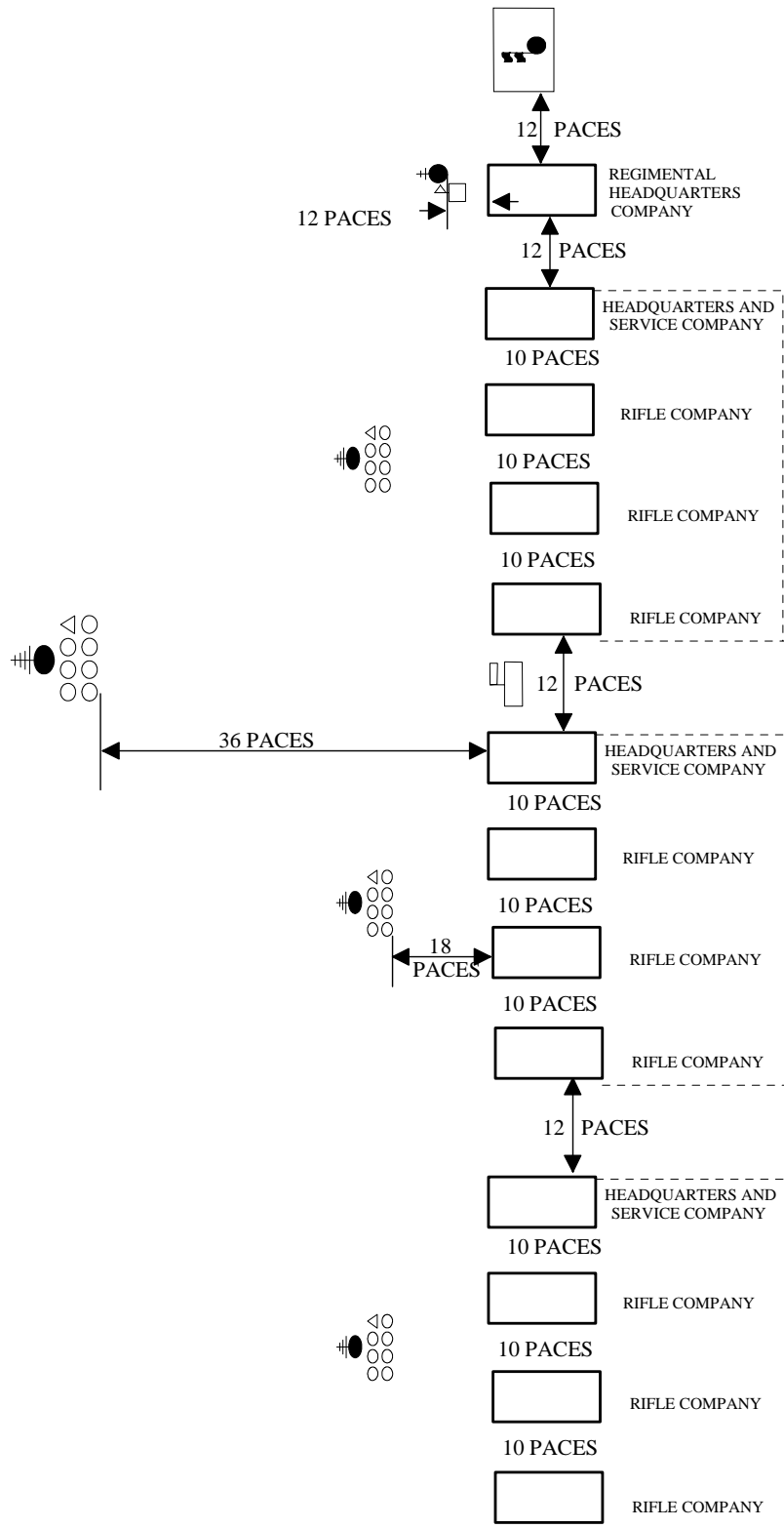

Figure 12-6.--Regiment in Line with Battalions in Line, Company Mass Formation.

12004. TO DISMISS THE REGIMENT. To dismiss the regiment, the regimental commander orders the battalion, and independent company commanders to dismiss their commands.



MARINE CORPS DRILL AND CEREMONIES MANUAL

PART I: DRILL

CHAPTER 13

INSPECTIONS

	<u>PARAGRAPH</u>	<u>PAGE</u>
GENERAL . . . . .	13000	13-3
COMPANY FORMATIONS . . . . .	13001	13-3
INSPECTION OF PERSONAL FIELD EQUIPMENT IN RANKS . . . . .	13002	13-4
INSPECTING OFFICER OTHER THAN COMPANY COMMANDER . . . . .	13003	13-6
BATTALION INSPECTIONS . . . . .	13004	13-6
REGIMENTAL INSPECTION . . . . .	13005	13-7
INSPECTION OF QUARTERS OR CAMP . . . . .	13006	13-7

FIGURE

13-1	COMPANY FORMED FOR INSPECTION, COMPANY IN LINE . . . . .	13-8
13-2	COMPANY FORMED FOR INSPECTION, COMPANY COLUMN OF PLATOONS IN LINE . . . . .	13-9
13-3	INSPECTION OF PERSONAL FIELD EQUIPMENT IN RANKS . . . . .	13-10
13-3a	INSPECTION OF PERSONAL FIELD EQUIPMENT IN RANKS, PLATOON SPACING . . . . .	13-11



MARINE CORPS DRILL AND CEREMONIES MANUAL

PART I: DRILL

CHAPTER 13

INSPECTIONS

13000. GENERAL. The company is the basic unit for inspection. Battalion, regimental, and higher commanders or inspecting officers inspect each company in its own area, or have it march to a specified place at a designated time for inspection. Under special conditions, an entire battalion or regiment may be inspected in one large formation.

13001. COMPANY FORMATIONS

1. General. The company forms in line or in column of platoons in line as prescribed in chapter 10. If transportation is included, it forms 12 paces in rear of the troops. Drivers remain with their vehicles. (See figure 13-1.)

2. Procedure

a. When ready to inspect, the company commander commands "PREPARE FOR INSPECTION." At this command, the platoon commanders open ranks by platoons. The right platoon executes the initial movement. The second platoon, as described in paragraph 9016, opens ranks when the front rank of the first platoon has been aligned. The third and subsequent platoons do not begin to open ranks until the front squad of the platoon to its right has been aligned. All platoon commanders align their squads on the corresponding squad of the platoon to their right. (See figure 13-1.) When the formation is a column of platoons in line, platoon commanders open ranks successively from front to rear without awaiting the alignment of the platoon to their front. They cause their units to cover the corresponding files to their front. (See figure 13-2.) In opening ranks and aligning their platoons, platoon commanders comply with the procedures prescribed for platoon drill. After verifying the alignment of the rear rank, each platoon commander faces to the right in marching, moves 3 paces beyond the front rank, faces the left, and commands "Ready, FRONT" and "COVER." After giving the command "COVER," each platoon commander takes one step forward and faces to the front, thereby being in a position 3 paces in front of the right file of the front rank of their respective platoon. It is at this post that the platoon commander receives the inspecting officer.

b. When all ranks have been opened, the company commander commands "AT EASE." He/she then inspects the company. During the inspection, officers, staff noncommissioned officers, and guidon bearers, not in ranks, come to attention at order arms as the company commander approaches. After being inspected, they resume at ease. The company commander may direct the first sergeant to accompany him/her for the purpose of taking notes. The inspection begins at the head of the column or the right of the line. The company commander inspects the arms, equipment, dress, and appearance of the personnel. As he/she approaches each platoon, its commander brings his/her unit to attention and salutes. After being personally inspected, the platoon commander returns sword (if so armed) and places himself/herself on the right of the company commander. He/she precedes the company commander during the entire inspection, down the front and rear of each squad. The company commander may direct that squads having been or not yet inspected be given at ease while he/she inspects others. In this case, the platoon commander complies and brings them to attention for inspection at the proper time.

c. The inspection is made from right to left in the front and from left to right in the rear of each rank. After inspecting the platoon commander, the company commander moves around the platoon commander's left to a position in front of the right flank Marine in the first rank. He/she moves from Marine to Marine by stepping off to the right in marching, taking one and one half steps, halting, and executing a left face. The platoon commander must move in the same manner so as not to be in the company commander's way.

d. Each Marine executes the movements to inspection arms for his/her weapon immediately after the company commander has completed the left face movement and is facing him/her.

e. The company commander takes all individual weapons from the individual being inspected. He/she takes the rifle by grasping the handguard with his/her right hand. The Marine whose rifle is being inspected immediately drops his/her hands to the sides. After inspecting the weapon, the company commander hands it back with his/her right hand in the same position. The Marine smartly takes his/her weapon by grasping the center of the handguard just forward of the slipring with his/her left hand, closes the bolt, pulls the trigger, and returns the weapon to order arms as soon as he/she receives it. The company commander takes and returns other weapons in the most convenient manner. A detailed inspection will include bayonets and other equipment carried.

f. Bayonets will be inspected when the company commander is in the rear of the rank. He/she will take and replace them without assistance from the Marine being inspected. The Marine will merely raise his/her left arm when the company commander takes and replaces the bayonet.

g. Upon completion of the inspection of his/her platoon, the platoon commander, having led the company commander down the rear of the last squad, executes column left and halts when 3 paces beyond the right flank member of the first rank. He/she faces left, calls the entire platoon to attention, and then resumes his/her post, (see paragraph 13001.2a) the company commander passes to his/her right, faces to the left in marching, halts, and executes a left face. He/she then gives the platoon commander any instructions necessary. The platoon and company commanders exchange salutes and the latter proceeds to the next platoon.

h. Upon completion of the inspection of each platoon, its commander faces to the left and orders "**Close Ranks, MARCH.**" At the command "**MARCH,**" the platoon commander moves by the most direct route and takes his/her post 6 paces in front of and centered on his/her platoon.

i. The company commander may direct the platoon commanders to make the detailed inspection by ordering "**Platoon Commanders, INSPECT YOUR PLATOONS.**" In this case, each platoon commander complies. They may direct their platoon sergeants to accompany them for the purpose of taking notes. The company commander will normally spot check individuals while platoon commanders are inspecting their platoons. In this case, Marines at ease will automatically come to attention upon the company commander's approach, and to inspection arms if the company commander stops in front of them, regardless of whether they have been previously inspected.

#### 13002. INSPECTION OF PERSONAL FIELD EQUIPMENT IN RANKS

1. The company forms in company column of platoons in line at open ranks, for a preliminary rifle inspection. After the inspection of the first platoon, the

company commander directs the platoon commander to prepare for inspection of equipment. Upon the company commander's departure to inspect the arms of the next platoon, the platoon commander orders, "**First Squad, 2 Paces Forward, MARCH;**" "**Second Squad, 1 Pace Forward, MARCH;**" and "**Fourth Squad, 2 Paces Backward, MARCH.**" (See figures 13-3 and 13-4.) The platoon commander then causes the platoon to take interval to the left, after which the Marine commands "**UNSLING EQUIPMENT.**" Upon the completion of this, the Marine orders "**DISPLAY EQUIPMENT.**"

2. At the command "**UNSLING EQUIPMENT,**" each Marine draws their bayonet and thrusts it into the ground, with their left hand, outside and against the left instep. The bayonet ring is to the front. Marines not armed with the bayonet mark the place with their left heels. This is to mark the rear right corner of the individual's equipment layout. Each member armed with a shoulder weapon lays it on the ground with muzzle to the front, barrel to the left, and butt near the toe of their right foot. The Marines then unslings their equipment and places it on the ground 1 foot in front of their feet. The top of the pack should be to the front and the side that faces rear when worn should be up. All Marines resume attention when finished.

3. At the command "**DISPLAY EQUIPMENT,**" packs are opened and equipment displayed as in current directives. The equipment is displayed in the interval to the left of each Marine. As Marines finishes arranging their equipment, each Marine resumes attention in their original position in ranks.

4. The company commander returns to the first platoon after inspecting the arms of the last. The company commander passes along the ranks from right to left as before. When, finished inspecting the platoon, the Marine directs the platoon commander to have the packs rolled and proceeds to the platoon commander of the next platoon to be inspected. The post and his/her action of the platoon commander during the company commander's arrival and departure is the same as described in paragraph 13001.2.

5. The platoon commander then commands "**ROLL PACKS.**" Each Marine assembles their equipment and rolls their pack. The member places it in front of themselves, as described in paragraph 13002.2 and comes to attention.

6. After all equipment is assembled and packs are rolled, the platoon commander commands "**SLING EQUIPMENT.**" All Marines sling packs, fasten belts, and take arms. They then assume their original place in formation, at attention and order arms.

7. The platoon commander then causes the platoon to close interval and then close ranks, after which the Marine gives "**REST**" or "**AT EASE.**"

8. In units such as weapons or headquarters and service companies, which have special combat equipment, the company commander, after packs have been opened, or after individual inspection, directs "**DISPLAY MACHINE-GUN, MORTAR, or other EQUIPMENT.**" Gun teams/squads under the direction of their leaders break ranks and lay out their weapons and accessories for inspection as described in the gun drill for that particular weapon. Headquarters personnel lay out their fire control, communication, or other equipment in a similar manner. Such equipment will be displayed 3 paces from the right of the squad's flank. The rear of the equipment is placed on line with the rear of the individual field equipment.

13003. INSPECTING OFFICER OTHER THAN COMPANY COMMANDER. Should the inspecting officer be other than the company commander, the latter will face the original front of Marine's company after commanding "AT EASE." Upon the approach of the inspecting officer, the inspection proceeds as previously explained. The company commander follows the inspecting officer.

13004. BATTALION INSPECTIONS

1. The battalion is formed in column of companies with companies in line or battalion in line with companies in line, as prescribed in chapter 11. Before the inspection, the battalion commander indicates whether crew-served weapons and special equipment are to be displayed. They may be laid out at the armory or left on their transportation for subsequent inspection.
2. When the companies are in position, the battalion commander commands "PREPARE FOR INSPECTION." At this command, all companies prepare as described in paragraph 13001. The color guard proceeds to a position 3 paces to the rear of the battalion staff.
3. The battalion commander then commands "REST," returns sword if so armed, and inspects battalion staff and color guard. The staff members come to attention without command, upon the battalion commander's approach, and execute order sword. When the battalion commander approaches the color guard, after inspecting the staff, the staff members return sword and accompanies the battalion commander. The senior color bearer brings the color guard to attention. The battalion commander may dismiss the color guard as soon as inspected.
4. The battalion commander, beginning at the right of the line or at the head of the column, inspects the arms, equipment, dress, and appearance of the personnel in each company.
5. As the battalion commander approaches each company, its commander calls it to attention, faces the front, and salutes. As soon as the company commander has been inspected, the company commander gives the unit "REST," returns sword if so armed, and accompanies the battalion commander during the inspection. The inspection proceeds as described in paragraph 13001.
6. The battalion commander may direct the company commanders to make the detailed inspections of their own companies, in which case the battalion commander will usually spot check individuals throughout the battalion. In such a case, all Marines react as described in paragraph 13001.2 upon the approach of the battalion commander. The battalion commander may also direct members of the battalion staff to inspect individual companies, in which case company commanders react as described in paragraph 13001.
7. After a company has been inspected, unless otherwise directed it may be marched from the field and dismissed.
8. When desired, the battalion commander may direct companies not being inspected to stack arms, fall out, and wait their turn in the immediate vicinity. In this case, company commanders so instructed must fall their Marines in and prepare for inspection in time so as not to delay the entire inspection.

2. If the inspecting officer is other than the battalion commander, the latter prepares the battalion for inspection in the same manner. Upon the approach of the inspecting officer, the battalion commander brings the battalion to attention, faces the front, and salutes. After being personally inspected, the commander gives the battalion "REST," returns sword if so armed, and accompanies the inspecting officer. The inspecting officer proceeds as previously prescribed for the battalion commander.

13005. REGIMENTAL INSPECTION. Only in an exceptional situation will an entire regiment be inspected in one formation. However, when held, the principles are the same as for the battalion. The regiment may be formed in any manner suitable to the available space and ground. Battalions are prepared for inspection as described in paragraph 13004. Upon the approach of the inspecting officer, each battalion commander brings their unit to attention and salutes. Battalion inspections then follow.

13006. INSPECTION OF QUARTERS OR CAMP

1. General. In quarters, the Marines stand near their respective bunks uncovered and without equipment or arms. In camp or bivouac, they stand outside their tents covered but without equipment or arms. If the inspection of individual equipment and/or clothing has been ordered, each Marine arranges the required articles as described in current directives.
- 2. Battalion. During the inspection of the quarters or camp of a company, the battalion commander is accompanied by the company commander and preceded by the first sergeant and a bugler. The first sergeant causes the bugler to sound "*Attention*" as the inspecting party approaches. In the absence of a bugler, the first sergeant uses the voice command. Such other officers as may be designated accompany the battalion commander on the inspection.
  3. Regimental. The procedure is the same as outlined in paragraph 13006.2 above. The regimental commander is accompanied by the battalion commander and commander of the company being inspected.

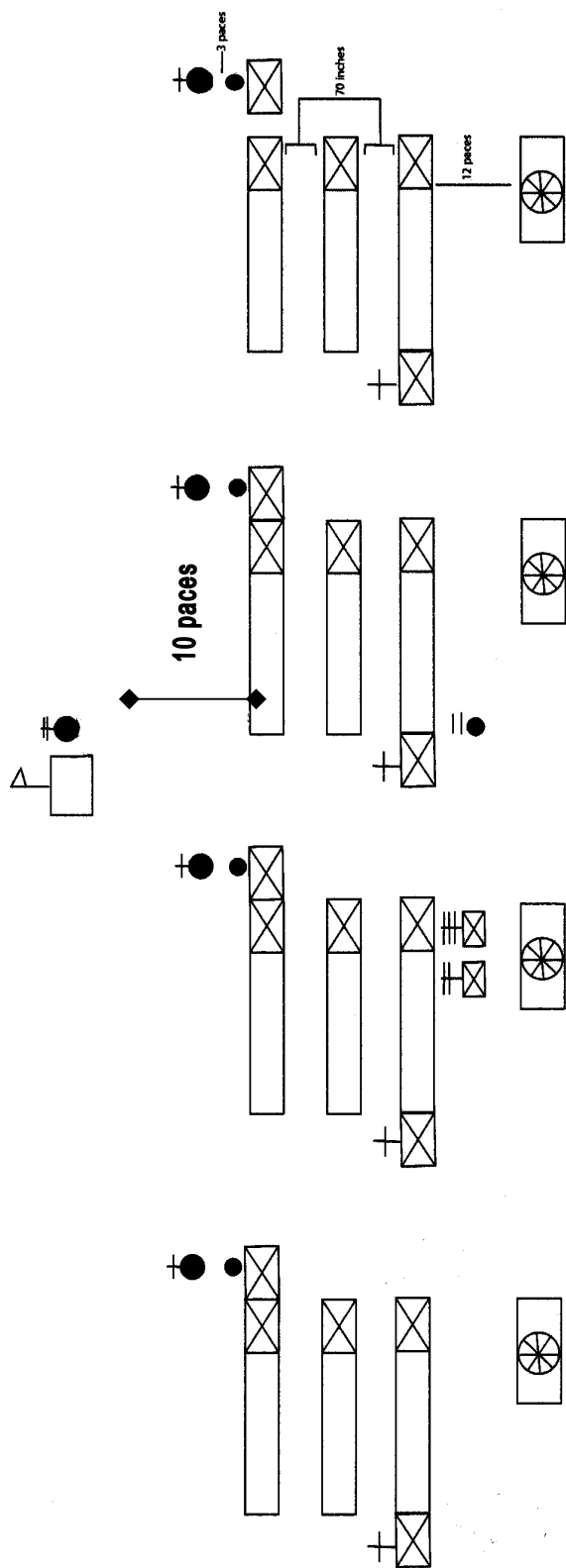

Figure 13-1.--Company Formed for Inspection, Company in Line.



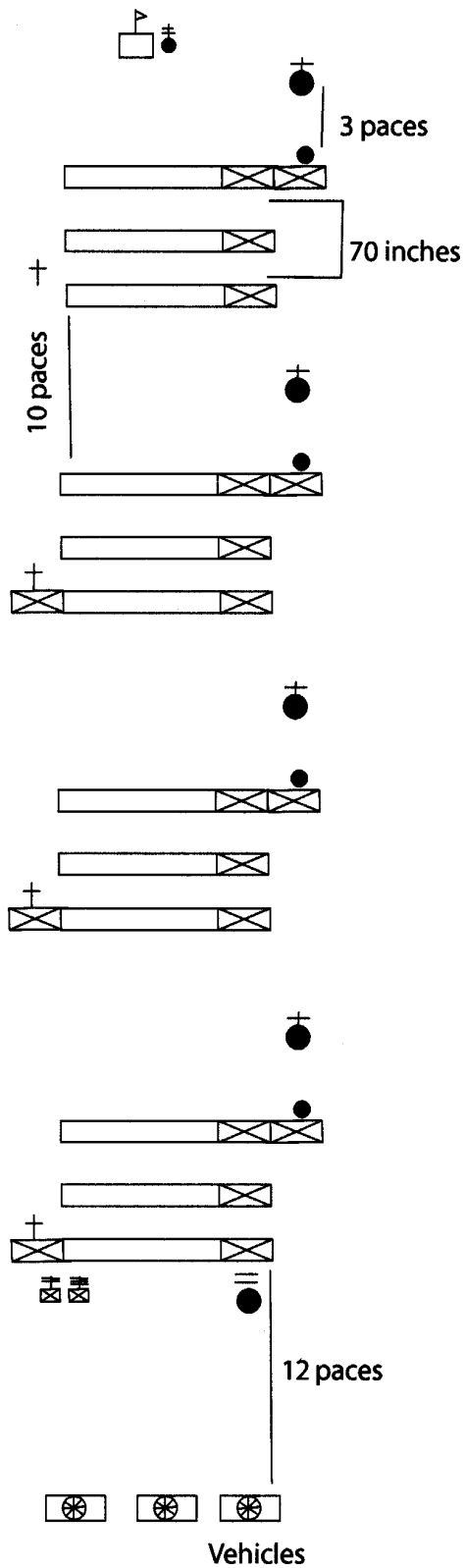

Figure 13-2.--Company Formed for Inspection, Company Column of Platoons in Line.

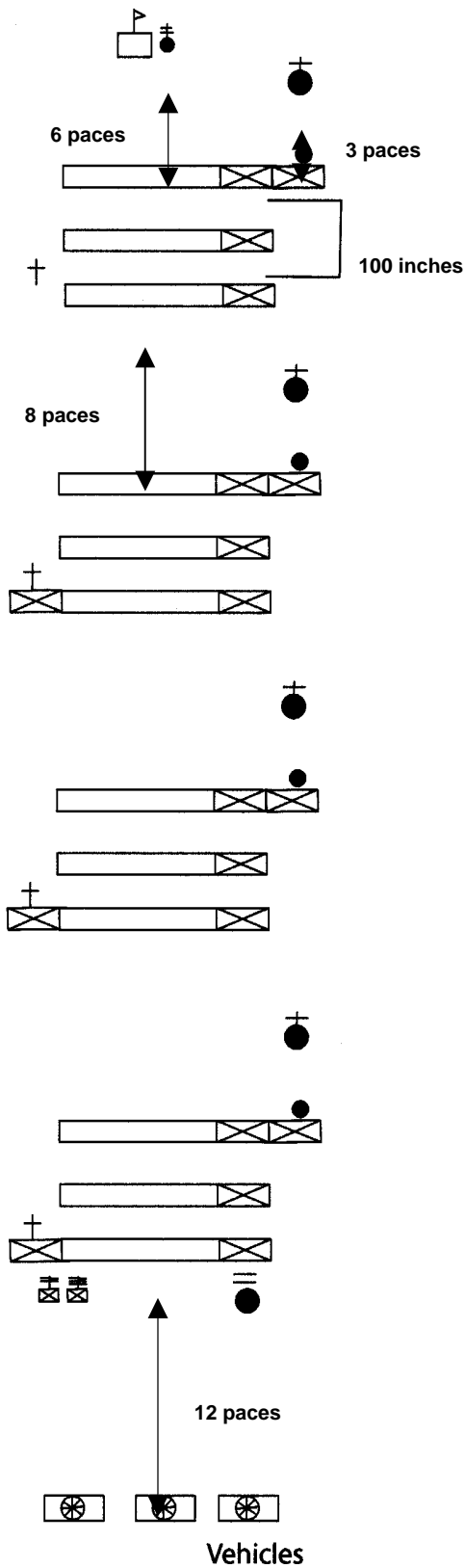

Figure 13-3.--Inspection of Personal Field Equipment in Ranks.

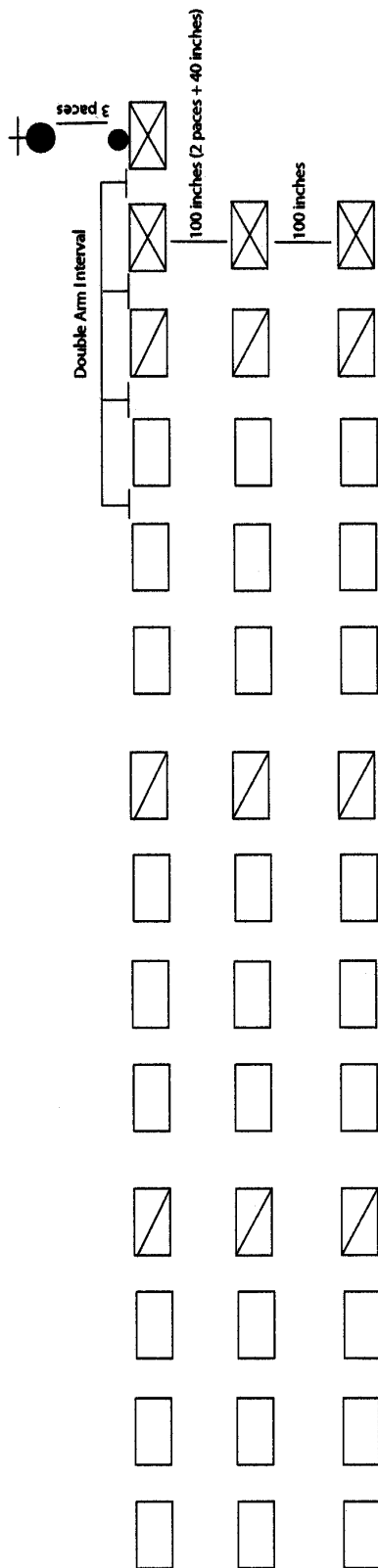

Figure 13-3a.--Inspection of Personal Field Equipment in Ranks, Platoon Spacing.

MARINE CORPS DRILL AND CEREMONIES MANUAL

PART I: DRILL

CHAPTER 14

ORGANIZATIONAL AND PARADE STAFF

	<u>PARAGRAPH</u>	<u>PAGE</u>
GENERAL . . . . .	14000	14-3
FORMING THE STAFF . . . . .	14001	14-3
STAFF SALUTES . . . . .	14002	14-5
MOVEMENTS OF THE STAFF . . . . .	14003	14-5
DISMISSING THE STAFF . . . . .	14004	14-12

FIGURE

14-1	THE STAFF . . . . .	14-3
14-2	STAFF FALL IN. . . . .	14-4
14-3	MARCH ON THE STAFF . . . . .	14-4
14-4	TURNING MOVEMENTS . . . . .	14-6
14-5	BOXING THE STAFF . . . . .	14-7
14-6	MOVEMENTS OF THE STAFF WHEN COLORS ARE BROUGHT FORWARD	14-9
14-7	MOVEMENTS OF THE STAFF FOR POSTING THE COLORS . . .	14-10
14-8	MARCHING IN REVIEW . . . . .	14-11



## PART I: DRILL

## CHAPTER 14

## ORGANIZATIONAL AND PARADE STAFF

14000. GENERAL

1. The staff officers of a commander form 2 paces to the commander's rear in one rank, at normal interval. Enlisted personnel form 2 paces to the rear of the commissioned officers in one rank, at normal interval. If only one staff officer is present, the Marine he is posted 1 pace to the right and 2 paces to the rear of the commander. Staff officers are arranged with the adjutant on the right and the S-2, S-3 and S-4 to the left in that order, but the commander may arrange them in any order. Enlisted personnel forming with the staff ordinarily are posted by seniority of grade from right to left. (See figure 14-1.) When enlisted personnel, e.g., a staff noncommissioned officers or noncommissioned officers, conduct a parade or ceremony the staff will consist only of enlisted.

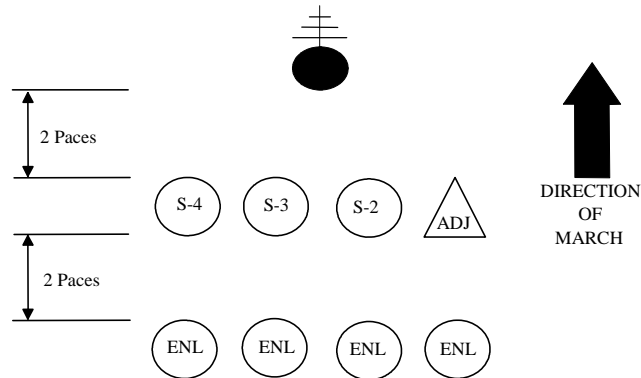

Figure 14-1.--The Staff.

- 2. All commands for the staff is preceded by the word **"Staff"** (e.g., **"Staff, Draw, SWORD"** and **"Staff, Eyes, RIGHT"**). Commands for the staff are given only loudly enough for the staff to hear in order to prevent the formation from prematurely executing a command. When giving sword commands to the staff, the commander of troops will always be at the same sword position as the staff and execute with them.

14001. FORMING THE STAFF

- 3. Prior to forming, the staff may be positioned together on either side of the reviewing area or spilt on opposite sides, depending on the layout of the reviewing area/parade field and the commander's desires. To form the staff for a parade or other ceremony, the commander moves to a position in front of the reviewing stand and centered between the dress guidons, halts facing the reviewing stand and command **"Staff, FALL IN."** The members of the staff move from their positions and form in front of, centered on and facing the commander. When the staff falls in they do not raise their arms nor turn their heads and eyes to the right for alignment. Once the staff is in position the commander does an about face and faces the line of troops. (See figure 14-2.)

Enclosure (1)

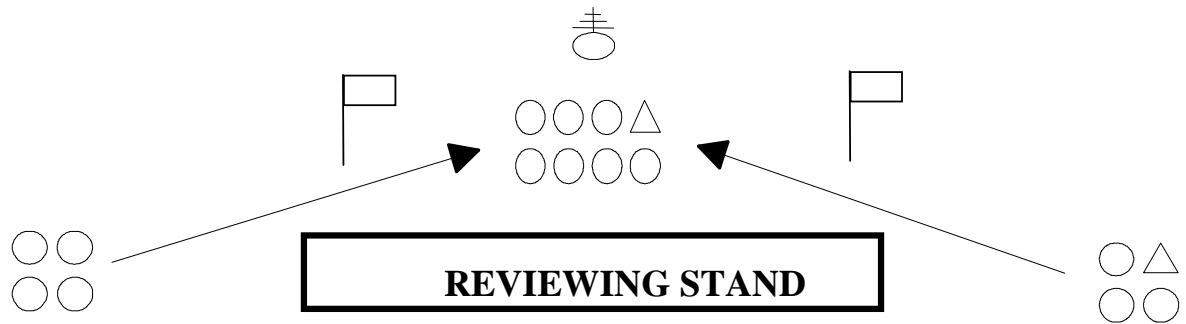

Figure 14-2.--Staff Fall In.

2. The staff, on the first note of the music following "*Adjutant's Call*," march forward on command of the commander of troops from their position in front of the reviewing area to a post midway between the reviewing area and the line of troops and halt facing the line of troops. (See figure 14-3.) If armed with swords they remain in the scabbards.

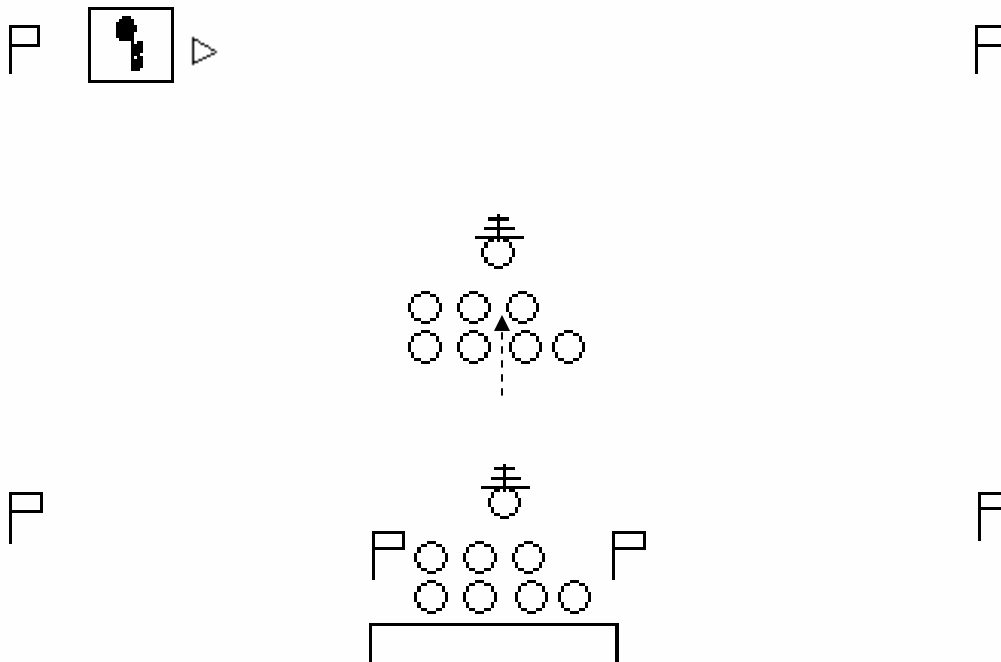

Figure 14-3.--March on the Staff.

- 3. The staff draws sword on the command of the commander. For the senior staff of a formation or parade this is done after the adjutant has formed the parade, reported to the commander and taken his/her post in the staff. The commander then commands "**Staff, Draw, SWORD**" and "**Staff, Order, SWORD.**" The commander remains at the carry. The staffs of subordinate commanders draw swords prior to marching the unit onto the field. The staff(s) remains at order sword except when:

Enclosure (1)

- a. Boxing the Staff.
- b. Moving to clear a path for the colors to be brought forward.
- c. When at present, parade rest, at ease or rest.
- d. Passing in review or any other marching or facing movements that require the staff to move.
- e. The staff, including the staffs of subordinate commanders, remains at the order during the manual of arms.

4. During regimental/group parades, at officers center all battalion/squadron commanders and their staff's close center on the original line of battalion/squadron commanders. Additionally, during division/wing parades the regimental/group commanders and their staffs, in addition to the battalion/squadron commanders and their staffs, close center on the original line of regimental/group commanders.

14002. STAFF SALUTES. Members of the staff salute with the commander, on the commander's separate command to the staff at the following times:

1. When passing in review.
2. When rendering honors.
3. When passing the national colors or the national colors pass to its front.
- 4. While the "National Anthem," "To The Color" "Hail to the Chief," "Taps," (when played for memorials) and other musical salutes that require a salute is played. Salutes are also rendered when "Retreat" is played during reviews and all ceremonies, except at evening parade. At evening parade, "Retreat" is played immediately after "Sound Off" while the troops are at parade rest, and is therefore not saluted. In this case, after "Retreat," troops are brought to attention and salutes are rendered while the "National Anthem" is played to lower the national ensign.
5. At any other time the troops are brought to present arms.

14003. MOVEMENTS OF THE STAFF

1. The staff marches 2 paces to the rear of the commander in two ranks. The staff changes direction by making turning movements vice column movements. The staff only marches in column when boxing the staff and when moving to the side in order to allow the color guard to march forward. The staff aligns to the right, except when making a turn, when the alignment shifts to the direction of the turn.
2. When the battalion commander faces to the right (left) and marches off, the staff follows by making a turning movement. The command is "**Staff, Right (Left) Turn, MARCH.**" (See figure 14-4.)

Enclosure (1)



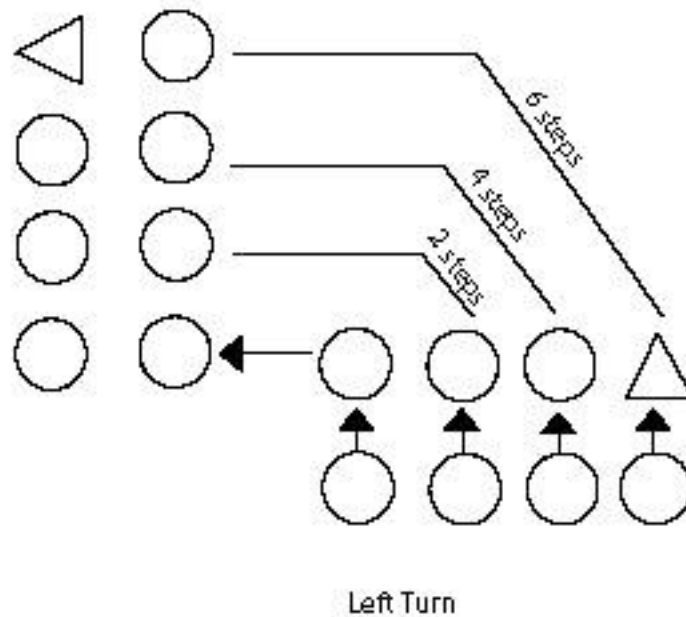
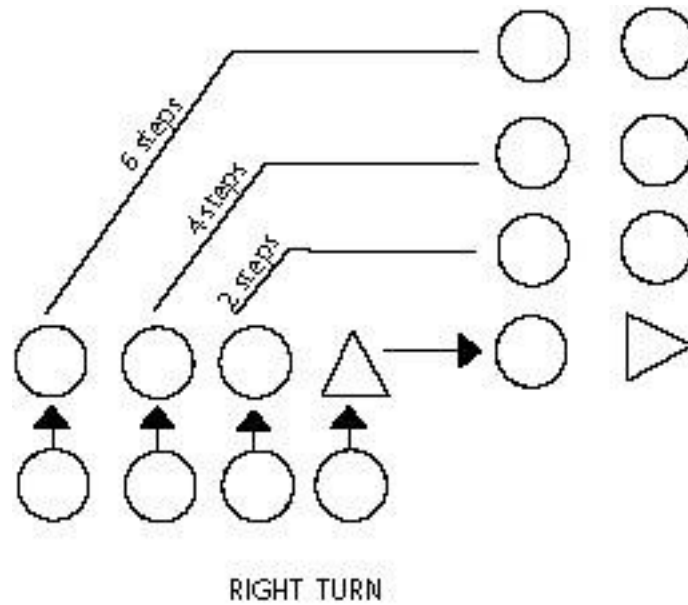

Figure 14-4.--Turning Movements.

3. During parades and other ceremonies when it is prescribed for the staff to change its position in order to place itself in the rear of the battalion commander (who has faced about, as when the battalion commander has formed the battalion and now faces the reviewing officer) the commander will order the adjutant (or senior staff officer) to **"BOX THE STAFF."** The adjutant would then give the following commands to the staff in order to place them to the rear of the commander. (See figure 14-5.)

- a. **"Staff, Carry, SWORD"** (if armed with swords).
- b. **"Staff, Left, FACE."**
- c. **"Staff, Column Right, MARCH."** (Second column right is executed without command. Once each staff member has reached their new position they automatically mark time.)
- d. **"Staff, HALT."**
- e. **"Staff, Right, FACE."**
- f. **"Staff, Order, SWORD"** (if armed with swords).

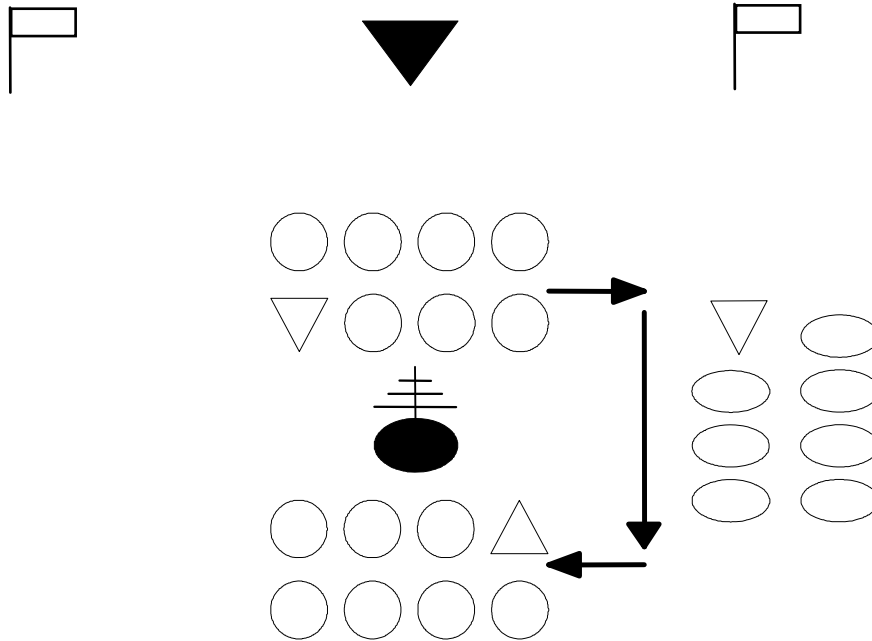

Figure 14-5.--Boxing the Staff.

- 4. During a parade or ceremony that requires the colors are brought forward the staff moves to one side (see figure 14-6, left side) on the commanders command of **"Personnel to Receive Awards, be Retired, etc., and All Colors, Center, MARCH"** in the following sequence:
- a. On the commander's command of **"Colors,"** the staff executes carry swords (if armed with swords).
  - b. On the commander's command of **"Center,"** the staff executes a right face.
  - c. On the commander's command of **"MARCH,"** the staff steps off and marches forward 8-10 paces. (The commander steps off towards the color guard after the staff have cleared.) The adjutant would then command:
    - d. **"Staff, HALT."**

Enclosure (1)

e. **"Staff, Left, FACE."**

Note: The staff does not salute the colors when they pass their position since the colors are passing the staff's flank and not the staff's front.

5. The commander marches forward to the color guard, halts, and salutes the colors and faces about. The commander then marches the color guard forward to the reviewing stand and halts. The Marines to be recognized then move to their position between the commander and color guard, unless marched forward with the color guard. (See chapter 18.)

→ 6. The staff returns to its original position (see figure 14-6, right side) after the color guard has halted using the following commands:

a. **"Staff, Left, FACE."**

b. **"Staff, Forward, MARCH"** (8-10 paces).

c. **"Staff, HALT."**

d. **"Staff, Right, FACE."**

e. **"Staff, Order, SWORD"** (if armed with swords).

7. Once the Marines to be recognized are present (see chapter 18) and the staff is back in its position, the commander salutes the reviewing officer and states, "Sir/Ma'am, Personnel to \_\_\_\_\_ and all Colors are Present."

a. The reviewing officer returns the salute and directs the commander to **"Present the Command."**

b. The commander, goes to carry sword, steps right in marching and moves to a position between the staff and color guard (saluting the colors as he/she passes them) and halts facing the line of troops and commands the unit to **"Present, ARMS."** (See figure 14-6, right side.)

c. The commander then faces the reviewing officer and gives the command **"Staff, Present, SWORD (ARMS)."** The staff, color guard and Marines being recognized salute.

d. After the last note of the music the commander would command **"Staff, Order, SWORD (ARMS)."** The staff, color guard and Marines being recognized terminate their salutes.

e. The commander then faces about and gives the command of **"Order, ARMS"** to the formation.

f. The next command would depend on the particular sequence of events for that particular ceremony.

Enclosure (1)

14-8

Ch 1

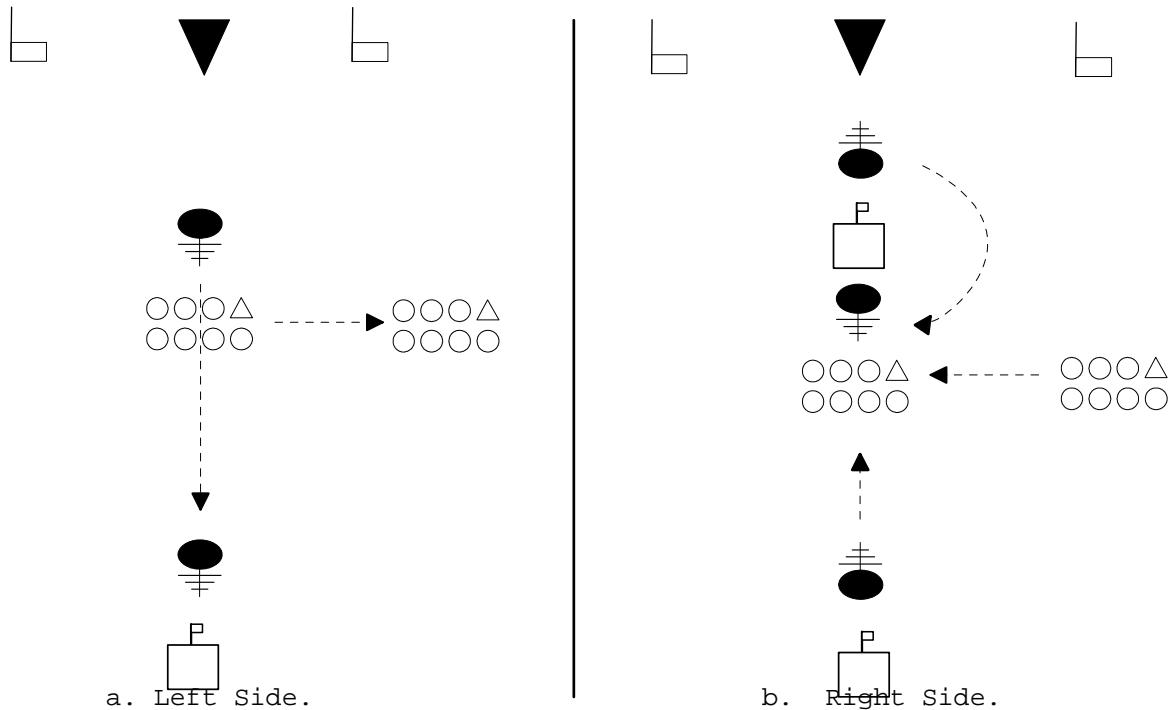

Figure 14-6.—Movements of the Staff When Colors are Brought Forward.

- 8. Once the awards ceremony is completed the commander causes the color guard to return to the line of troops (see figure 14-7, left side), and Marines being recognized to move to their next position by giving the following commands:
- a. **"Staff, Carry, SWORD,"** (if armed with swords) the staff goes to carry swords; the color guard goes to carry color.
  - b. **"Staff, Right, FACE,"** the staff executes a right face the award recipients execute a left face.
  - c. **"Staff, Forward, MARCH,"** the commander and staff march forward 8-10 paces. The color guard executes a countermarch and returns to its position in the line of troops. The Marines being recognized move to their designated position. (See chapter 17.)
  - d. **"Staff, HALT."**
  - e. **"Staff, Left, FACE."**
- 9. The commander returns the staff to its original position after the color guard has cleared that position (see figure 14-7, right side) using the following commands:

Enclosure (1)

- a. "Staff, Left, FACE."
- b. "Staff, Forward, MARCH" (8-10 paces).
- c. "Staff, HALT."
- d. "Staff, Right, FACE," the commander executes a left face to observe the color guard returning to its position.
- e. "Staff, Order, SWORD," (if armed with swords). When the color guard is in position, and at the order, the commander faces the reviewing officer and awaits the next command. (Normally to "MARCH THE COMMAND IN REVIEW.")

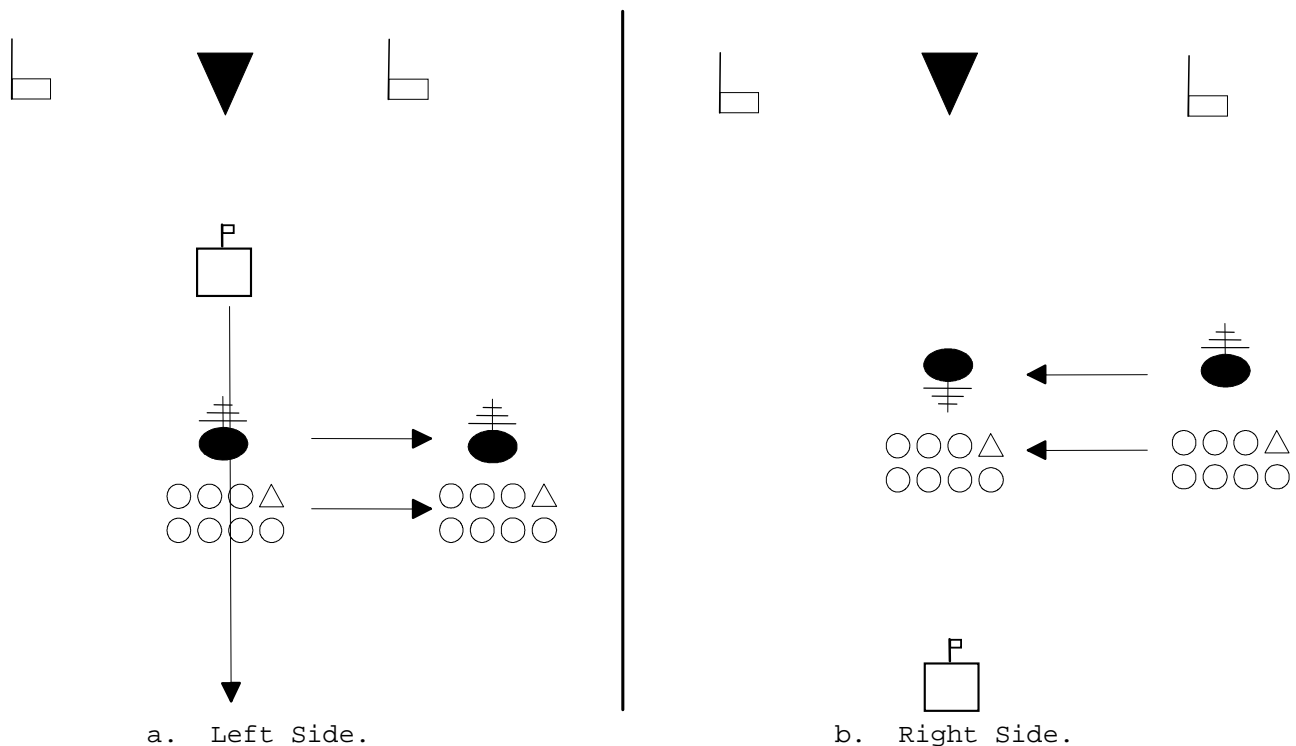

Figure 14-7.--Movements of the Staff for Posting the Colors.

- 10. When the commander receives the command to **"MARCH THE COMMAND IN REVIEW,"** after exchanging salutes with the reviewing officer, the commander faces the line of troops and gives the command to **"PASS IN REVIEW."**
- a. The command is prepared to pass in review per the selected sequence of events.
  - b. The commander and staff step off when the command of execution **"MARCH"** is given by the commander of the lead element in the parade.

Enclosure (1)

c. The commander and staff marches down the line and execute two left turns in order to be positioned in front of the band. However, subordinate commanders and staffs that are part of a larger parade unit (e.g., regimental parade) would march parallel to the line of troops and execute a left turn in order to be positioned at the head of their command.

d. As commanders and staffs approach the reviewing area each commander gives the command of **"Staff, Eyes, RIGHT (LEFT),"** and as the reviewing area is cleared **"Staff, Ready, FRONT."** When executing eyes right when either armed with a sword or unarmed all members on the command **"Staff, Eyes, RIGHT (LEFT),"** execute either present sword or a hand salute. All members of the staff turn their heads and eyes to the right (left) except the extreme right (left) file.

→ e. The senior commander and staff continue to march down the line of troops to the end of the reviewing area, or other designated point, where they will turn out of the line of march and be positioned to observe the march in review (e.g., they may execute three right turns, see figure 14-8).

f. Subordinate commanders and their staffs, after marching in review, would lead their command from the field.

g. The senior commander, after the staff is halted, commands the staff to **"Staff, Return, SWORD."** The senior commander gives the commands of **"Hand, SALUTE"** and **"Ready, TWO"** as the color guard(s) pass their position.

h. After the rear element of the command (normally the band) has passed the staff's position and exited the field, the commander faces the reviewing officer and salutes. After the salute is returned the commander may:

(1) The commander and the staff draw swords and follow the command from the field.

(2) Dismiss the staff.

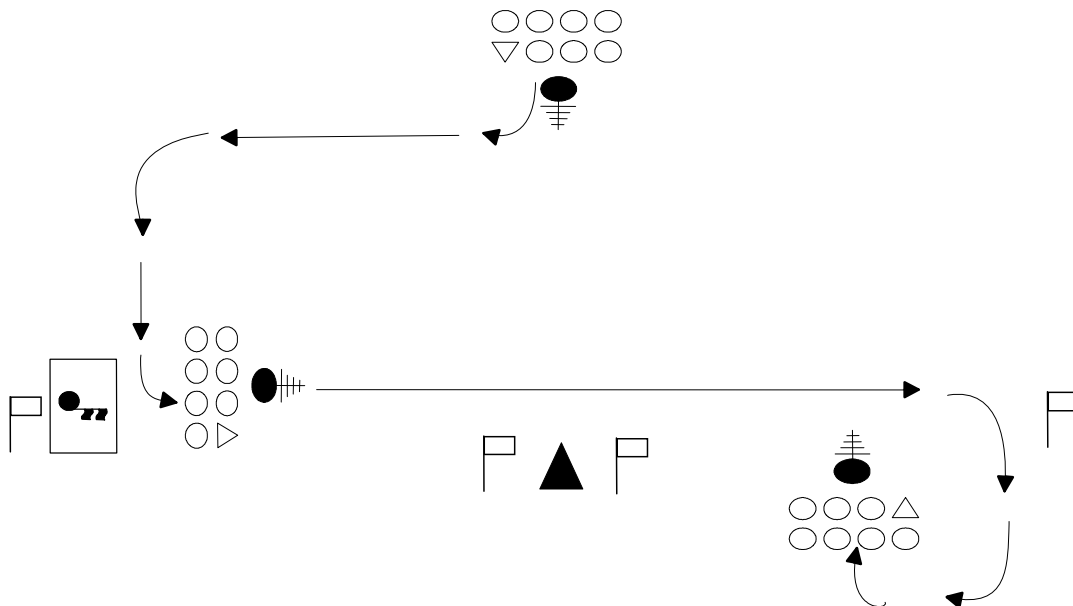

Figure 14-8.--Marching in Review.

Enclosure (1)

14004. DISMISSING THE STAFF. When the commander dismisses the staff, the staff must be at attention and swords returned. The commander, facing the staff, commands "**Staff, DISMISSED.**" The staff would take one step to the rear with the left foot, halt and execute a hand salute. The commander would return the salute. The staff would terminate the hand salute, face about and depart.

MARINE CORPS DRILL AND CEREMONIES MANUAL

PART II: CEREMONIES

CHAPTER 15

GENERAL INFORMATION

	<u>PARAGRAPH</u>	<u>PAGE</u>
GENERAL . . . . .	15000	15-3
ARRANGEMENT OF UNITS IN FORMATION . . . . .	15001	15-3
PLACE OF FORMATIONS . . . . .	15002	15-4
ORGANIZATIONS AND STRENGTH OF UNITS . . . . .	15003	15-5
COMMANDS, DRILL MOVEMENTS, AND UNIT FORMATIONS . . . . .	15004	15-5
UNIFORM AND EQUIPMENT . . . . .	15005	15-5
CEREMONIES CONDUCTED INDOORS . . . . .	15006	15-5
MARKING PARADE FIELDS . . . . .	15007	15-6
KEY PERSONNEL AND REHEARSALS . . . . .	15008	15-9
CEREMONIAL ATMOSPHERE . . . . .	15009	15-10
CEREMONIAL CHECKLIST . . . . .	15010	15-11

FIGURE

15-1	FINDING THE CENTER OF THE FIELD . . . . .	15-7
15-2	SAMPLE MARKING FOR COMPANY IN LINE . . . . .	15-7
15-3	SAMPLE MARKING TO FORM A COMPANY MASS FROM A COMPANY COLUMN . . . . .	15-8
15-4	SAMPLE MARKING FOR THE ADJUTANT, COMMANDER OF TROOPS AND STAFF . . . . .	15-8
15-5	CEREMONIAL CHECKLIST . . . . .	15-11





MARINE CORPS DRILL AND CEREMONIES MANUAL

PART II: CEREMONIES

CHAPTER 15

GENERAL INFORMATION

15000. GENERAL

1. There are numerous occasions for the conduct of a ceremony but all are special events to celebrate or honor units or deserving individuals. These ceremonies will normally be conducted as a review, parade or indoor ceremony as outlined in chapters 16 and 17. The following are specific occasions for a ceremony and details for each can be found in chapters 18 through 21, and chapters 23 and 24.

- a. Presentation of decorations and individual retirements.
- b. Change of command ceremony
- c. Relief and appointment of the Sergeant Major.
- d. Activation and/or deactivation of a unit.
- e. Marine Corps birthday cake cutting ceremony.
- f. Unit mess night or dining-in.

2. Military funerals and memorial services are ceremonies conducted per the provisions of chapter 25 with the procedures for firing details outlined in chapter 26.

15001. ARRANGEMENT OF UNITS IN FORMATION

1. In ceremonies involving the U.S. Marine Corps and U.S. Navy units, the Marine unit shall be on the right of line or head of the column. The senior line officer, regardless of service, functions as the commander of troops.

2. In ceremonies involving other services of the United States, the order of formation from right to left in line and front to rear in column is as indicated below. The senior line officer, regardless of service, functions as the commander of troops.

- a. Cadets, United States Military Academy.
- b. Midshipmen, United States Naval Academy.
- c. Cadets, United States Air Force Academy.
- d. Cadets, United States Coast Guard Academy.
- e. United States Army.
- f. United States Marine Corps.
- g. United States Navy.

- h. United States Air Force.
  - i. United States Coast Guard.
  - j. Army National Guard of the United States.
  - k. Army Reserve.
  - l. Marine Corps Reserve.
  - m. Naval Reserve.
  - n. Air National Guard of the United States.
  - o. Air Force Reserve.
  - p. Coast Guard Reserve.
  - q. Other training organizations of the Army, Marine Corps, Navy, Air Force, and Coast Guard in that order, respectively.
  - r. During any period when the United States Coast Guard shall operate as part of the United States Navy, the Cadets, United States Coast Guard Academy, the United States Coast Guard, and the Coast Guard Reserve shall take precedence, respectively, next after the Midshipmen, United States Naval Academy, The United States Navy; and the Naval Reserve.
3. When foreign troops are invited to participate in ceremonies within the territorial jurisdiction of the United States, they will be assigned a position of honor ahead of United States troops. A small detachment of United States troops will immediately precede the foreign troops as a guard of honor.
4. When troops of two or more foreign nations participate, the order of precedence among them will be determined, except for the provisions of paragraph 15001.3 above, by the commander of troops per one of the following methods, whichever is deemed most appropriate:
- a. The relative ranks of the commanders of the forces from which the ceremonial detachments are drawn.
  - b. The relative ranks of the commanders of the ceremonial detachments.
  - c. The alphabetical order in the English language of the names of the nations concerned.
5. After troops are formed, subordinate commanders and their staffs face front. The commander of troops and the staff face the command. The commander of troops and the staff face front to present the command to the reviewing officer.

#### 15002. PLACE OF FORMATIONS

1. At "Assembly," companies are formed and inspected by their company commanders at their designated assembly area.

2. At "Adjutant's Call," for a ceremony involving a single battalion, the battalion forms in its assembly area and conducts the ceremony. For a regimental ceremony, at the first "Adjutant's Call," each battalion forms in its assembly area and the battalion reports to its commander. At the second sounding of "Adjutant's Call," the regiment is formed and the ceremony is conducted.

3. For ceremonies conducted by organizations larger than a regiment, such as a division, at the second "Adjutant's Call," each regiment is formed and is reported to its commander. At the third "Adjutant's Call," the command is formed and the ceremony is conducted.

#### 15003. ORGANIZATIONS AND STRENGTH OF UNITS

1. For formations, reviews, and parades when maximum troop participation is desired, units are organized, in as much as practicable, according to their actual tables of organization. Size of units will vary according to actual strengths as will the number of companies in each battalion and platoons in each company. Similarly, the number of ranks in each platoon will vary according to the number of squads. For units not organized by table of organization into squads, they should be formed so that platoons are in three ranks in line and three files in column.

2. When the appearance of troops in formation is of primary concern, the organization and strength of participating units should be standardized. Each platoon should be organized so as to form in three ranks in line and three files in column. The strength of each platoon should be the same so that, when in line, all platoons occupy the same frontage.

#### 15004. COMMANDS, DRILL MOVEMENTS, AND UNIT FORMATIONS

1. During ceremonies, unit commanders give commands, units execute drill movements, and units employ formations as prescribed for squad, platoon, company, battalion and regimental drill.

2. Commanders may modify formations for ceremonies when the nature of the ground or exceptional circumstances requires such changes. Normally, modifications are generally limited to adjusting the paces specified for intervals and distances in a given formation to fit the ground used for conduct of the ceremony.

15005. UNIFORM AND EQUIPMENT. The organization, uniform, arms and equipment of units participating in ceremonies, along with any other necessary administrative information, are prescribed by the commander of troops, or may be prescribed by unit standing operation procedure to preclude the necessity of frequent repetition in individual ceremony orders. Commanders will not designate any of the above when it will be in direct violation of other applicable Marine Corps orders, i.e., Marine Corps Uniform Regulations.

#### 15006. CEREMONIES CONDUCTED INDOORS

1. In addition to reviews and parades conducted per chapters 16 and 17, there will be occasions when an indoor ceremony would be more appropriate or necessary, as is the case during inclement weather. Indoor ceremonies can be conducted for change of command, relief and appointment of the sergeant major, awards, retirement, activation and deactivation of units, honors, promotions, and the graduation of

formal schools. If the ceremony is conducted in a large structure such as a gymnasium or hanger, many of the elements of a review or parade may be used. However, if the location for the indoor ceremony is a banquet hall, theater, auditorium, or classroom and space is limited, then the ceremony will be modified using the following guidelines.

a. At a minimum the indoor ceremony may contain the following elements in the order shown.

- (1) Pre-ceremony music (optional).
- (2) Invocation (optional).
- (3) "*National Anthem*" (see paragraph 15006.2).
- (4) Honors (as required).

(5) At this point the ceremony will proceed depending on the occasion. Colors are passed for a change of command; the sergeants major are relieved and appointed; awards, retirements and promotions are effected; diplomas or certificates for graduations are delivered.

(6) Remarks if appropriate (remarks may also be done prior to the procedures outlined in paragraph 15006.1a above for graduation ceremonies).

(7) Benediction (optional).

→ (8) "*Anchors Aweigh*" and "*Marines' Hymn.*"

2. Color Guard. For indoor ceremonies the color guard may be omitted and colors pre-staged in flag stands per the procedures in chapter 7. If colors are used the procedures outlined in paragraph 7307 will be followed.

3. When special circumstances, such as the use of gymnasiums, hangars, and hangar bays dictate, the commander may direct that participants remain covered and render appropriate salutes as required for the particular ceremony. In such instances, commanders will detail the specific requirements for remaining covered and rendering appropriate salutes.

#### 15007. MARKING PARADE FIELDS

1. Parade fields may be marked using paint, chalk, circular markers (coffee can lid) or any other means at the unit's disposal. Conditions and type of surface of the parade field must also be taken into consideration prior to marking. For instance, if a grass field is used, and it is to be mowed prior to the ceremony, then paint would be a better choice than circular markers, which may damage mowing equipment. Additionally, if more than one unit of a different size uses the parade field, chalk may be a better option than paint.

2. The line on which troops are to form and along which they are to march is marked out or otherwise designated by the unit's sergeant major or senior enlisted assisted by the unit's G/S-3. The post of the reviewing officer, opposite the center of the line of troops, is marked on each flank with a dress guidon that is 6 paces from the line of march. The corners of the parade field are also marked with dress guidons. Additionally, the posts of the commander of troops, adjutant(s), subordinate unit commanders, guides, the color guard, officers center and turning points should be marked.

Enclosure (1)

3. To begin marking a field for a ceremony, first determine the location of the reviewing officer; this becomes the centerline for the field. From the reviewing officer's location, move approximately 100 paces directly to the front. This spot is the location of the color guard that should always be centered on the reviewing officer's spot. Begin marking the line of troops from the color guard's spot outboard to ensure the formation is symmetrical. (See figure 15-1.)

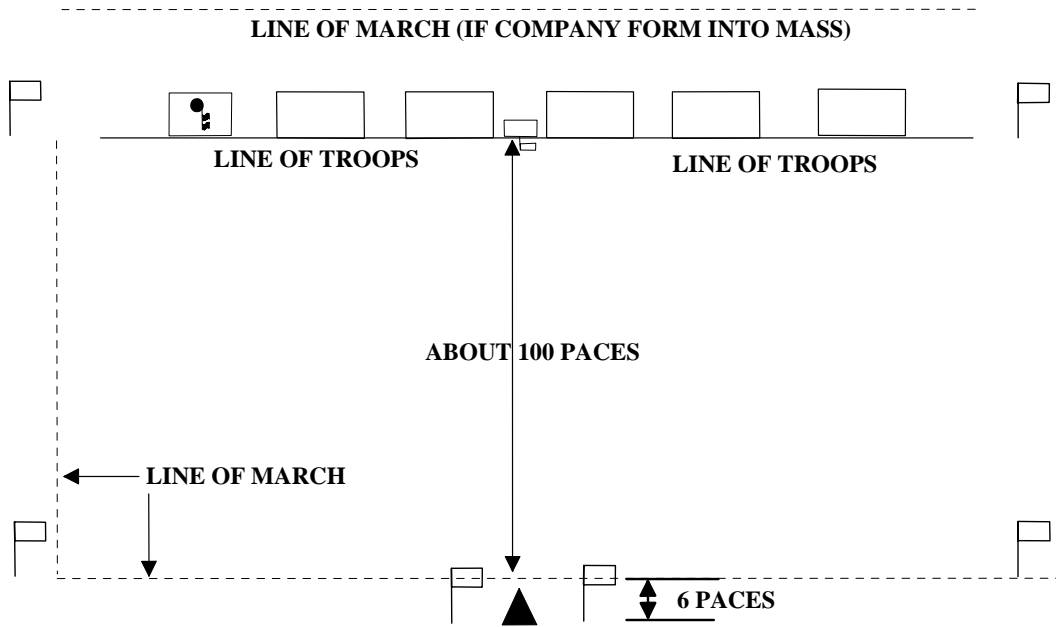

Figure 15-1.--Finding the Center of the Field.

4. The next positions to be marked are where the subordinate units are to come to rest on the line of troops. For a battalion size unit the minimum markings are, guide on line, squad leaders, platoon commanders, company guides and company commanders. Examples of markings for a company in line, platoons on line are shown in figure 15-2. Examples of markings for forming a company in mass from a company in column are shown in figure 15-3.

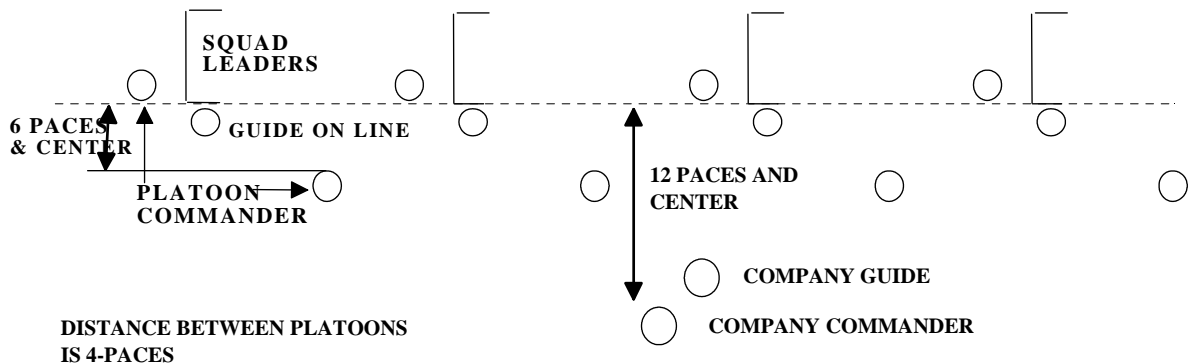

Figure 15-2.--Sample Marking for Company in Line.

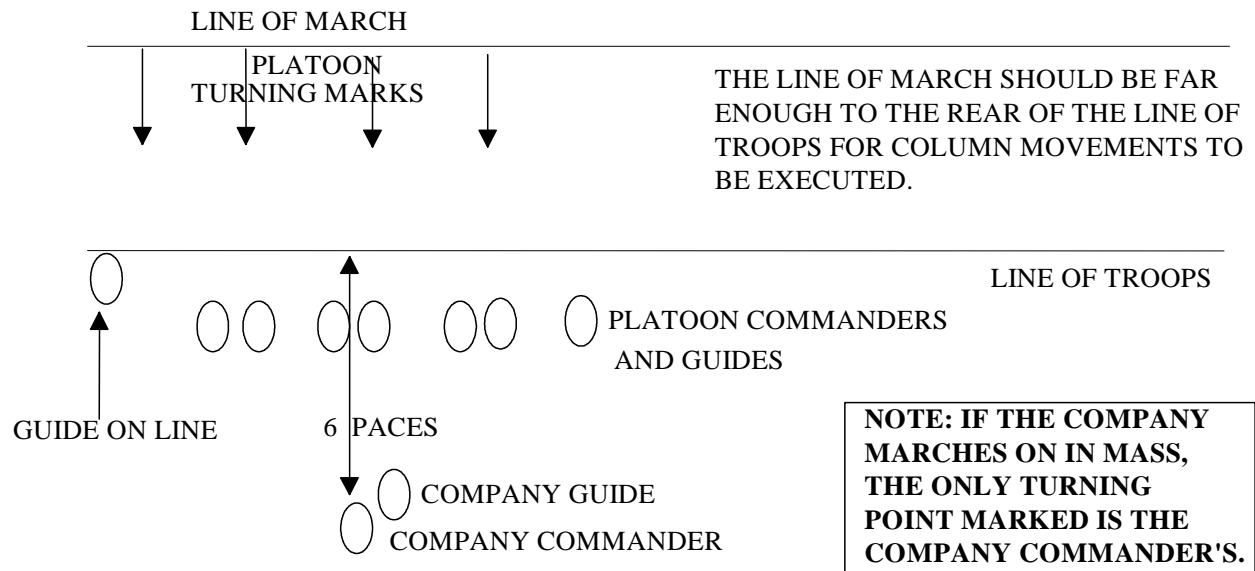

Figure 15-3.--Sample Marking to Form a Company Mass from a Company Column.

5. After the positions for all marching elements of the ceremony are marked the positions of the adjutant, commander of troops and staff to include subordinate commanders and staffs. (See figure 15-4.)

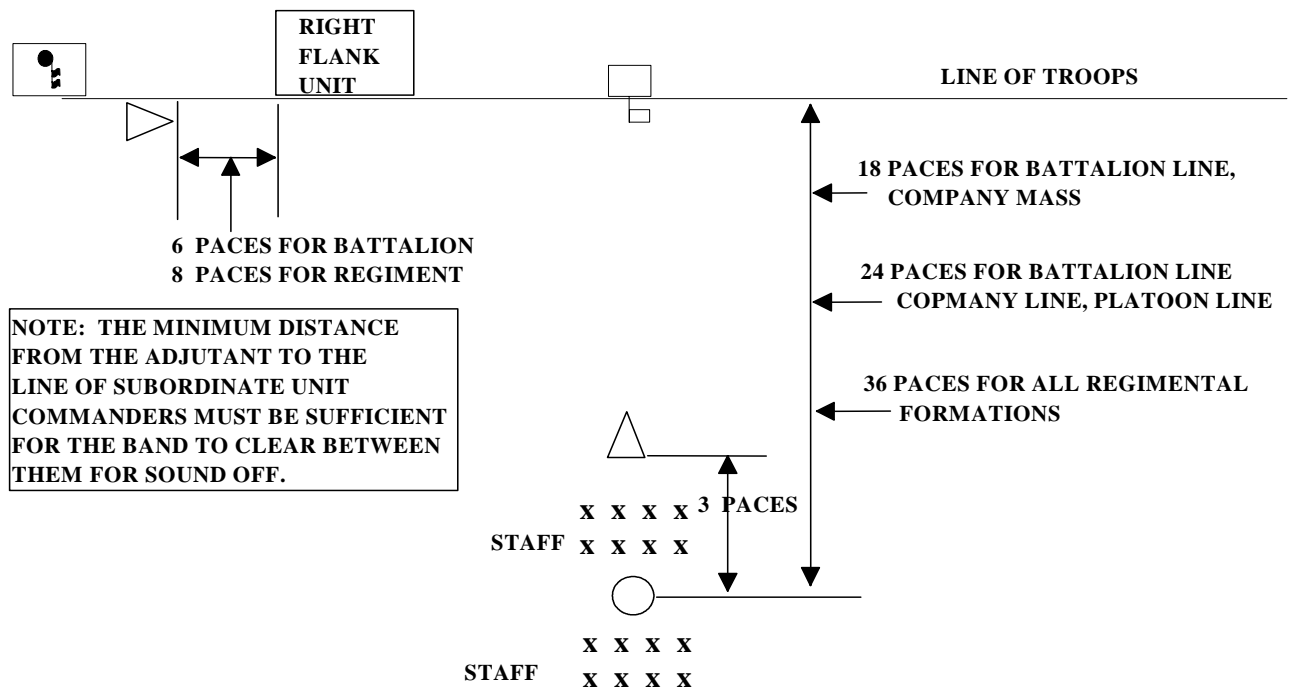

Figure 15-4.--Sample Marking for the Adjutant, Commander of Troops and Staff.

6. The final marking would be for officer's center. During officer's center, battalion commanders, and their staffs, company commanders, company guides and platoon commanders march directly to the center from their position in formation at the command march. Company commanders oblique slightly forward so that they are 4 paces ahead of the line of company guides. Usually a single long line (with Xs where the officers/guides halt) for each rank is marked on the field.

7. The minimum personnel needed to assist marking the field is the same as the number of Marines that comprise the "front" of each unit in the formation, plus two. For example to mark a company in line, platoons in line, 15 Marines are needed, 13 to mark the squad front, 1 for the platoon commander's position, and 1 for the platoon sergeant's position, in order to get the appropriate 4 paces between the platoons.

#### 15008. KEY PERSONNEL AND REHEARSALS

1. While not inclusive the key personnel for parade rehearsals normally consist of the following:

- a. Commander of troops and staff.
- b. Adjutant(s).
- c. Subordinate commanders and staffs.
- d. Color guard.
- e. Company commanders.
- f. Company guides.
- g. Platoon commanders.
- h. Platoon sergeants.
- i. Platoon guides.
- j. Squad leaders.
- k. Award recipients/retirees etc.
- l. Narrator.

2. In order to conduct a successful parade or ceremony sufficient rehearsals must be conducted. Normally, due to transportation; time spent drawing weapons; etc., only one all hands rehearsal is needed. The Marines participating in formation should be drilled in the manual of arms, marching in review, etc., in their company area in order to preclude excessively long or multiple all hand rehearsals. Key personnel are rehearsed exhaustively since they will make or break a parade or ceremony.

3. Key personnel rehearsals are usually scheduled in 2-hour blocks. The reason is that most parade sequence of events, less awards, speeches, etc., last from 35-45 minutes, depending on the size of the unit. Scheduling 2-hour blocks for rehearsals allows sufficient time to go over the sequence at least twice per rehearsal period. Normally key personnel rehearsals are conducted as follows:



a. The initial key personnel rehearsal is more of a class or "chalk talk" than an actual rehearsal. This chalk talk should clear up any fine points of the ceremony as well as clearly establishing who is in charge of the parade. The key personnel are briefed by senior enlisted concerning all aspects of the sequence of events for the parade as well as refresher training on the following:

- (1) The movements of the adjutant.
- (2) The movements of the commander of troops and staff.
- (3) The movements of the platoon commanders on dress right.
- (4) The movements of the guides on guides post.
- (5) The sword manual if so armed.

(6) If armed with swords, the officers and company guides are shown how to do a four-count halt at officer's center.

(a) On the first two counts, the officers and guides execute a halt.

(b) On the third count the officers execute the first count of present swords.

(c) For the fourth count the officers execute the second count of present swords and the company guides present guidons.

(7) If not armed with swords, the officers and company guides are shown how to do a four-count halt at officer's center.

(a) On the first two counts, the officers and guides execute a halt.

(b) On the third count all members will pause.

(c) On the fourth count the officers execute a hand salute and the company guides present guidons.

(8) The officers and company guides are shown the movements to return from officers center.

(9) Passing in review.

b. The second key personnel rehearsal should be a walk through of the sequence of events without repeating movements incorrectly executed. This rehearsal's sole purpose is to establish the sequence of events in the minds of all key personnel.

c. Third and subsequent key personnel rehearsals work on the polish of each movement made during the parade and ceremony. (e.g., officers center, dress right, box the staff, etc.)

15009. CEREMONIAL ATMOSPHERE. On the day of the ceremony it is appropriate to create something called "Ceremonial Atmosphere." This should be done approximately 45 minutes prior to the ceremony. At this time all fixed installations should be

in place to include, dress guidons, the firing battery, tentage, seating, etc. If there are buildings adjacent to the ceremony area then care must be taken to place windows, blinds, and curtains in the same position for uniformity. Excess gear should be removed. Sentries should be posted to prevent persons from entering the ceremonial area during the period when the ceremony is being conducted.

15010. CEREMONIAL CHECKLIST. Figure 15-5 is a sample ceremony execution checklist that can be used when planning various types of ceremonies. It is based on a 60-day reverse planning timeline. This sample can be modified to fit local requirements and timelines.

<u>DATE</u>	<u>SECTION</u>	<u>ACTION REQUIRED</u>	<u>REMARKS</u>
C-60	CG/CO	Identify type of ceremony and date of event	_____
C-58	G/S-3	Request band for ceremony and to provide taped music for rehearsals. Ensure band support includes one rehearsal and a 20-minute concert prior to the start of ceremony.	_____
C-45	G/S-3	Publish 5060 bulletin or LOI.	_____
C-45	G/S-1	Request guest lists as appropriate for those being honored.	_____
C-40	G/S-3	Chair parade coordination meeting.	_____
C-30	G/S-1	Consolidate guest list and mail all invitations. Prepare RSVP roster for use by phone watches.	_____
C-30	G/S-1	Acquire biographies and photographs for those being honored for inclusion in the program.	_____
C-30	G/S-1	Submit proposed program for review.	_____
C-30	G/S-3	Request photographic coverage, still and video from local CVIC.	_____
C-30	G/S-3	Request "Quiet Hours" from appropriate agencies.	_____
C-30	G/S-1	Prepare a "Narration" for the ceremony, include copies of orders, award citations, retirement certificates, and spouse LOAs as required.	_____

Figure 15-5.--Ceremonial Checklist.

<u>DATE</u>	<u>SECTION</u>	<u>ACTION REQUIRED</u>	<u>REMARKS</u>
C-30	G/S-4	Request tentage, seating and other requirements identified in the Bulletin/LOI.	_____
C-30	G/S-4	Request "Quiet Hours" from civilian contractors.	_____
C-20	G/S-3	Ensure final coordination has been made with all units to deconflict scheduling problems.	_____
C-15	G/S-1	Coordinate with chaplain's office to identify who will provide invocation for ceremony.	_____
C-15	Comdrs	Provide G/S-3 with a by name list of key personnel.	_____
C-15	G/S-1	Deliver program to Defense Printing Service ensure pickup.	_____
C-15	G/S-3	Pick up copy of rehearsal tape with ceremony music from band.	_____
C-15	G/S-1	Request PAO coverage, provide copy of "Narration" to PAO.	_____
C-15	G/S-3	Coordinate traffic and force protection measures with military police.	_____
C-15	G/S-1	Identify if a reception is being held.	_____
C-14	G/S-4	Request mowing of parade field and surrounding areas.	_____
C-14	G/S-4	Develop parking plan and coordinate with G/S-3.	_____
C-10	G/S-6	Provide a public address system for the rehearsals and ceremony, to include a cassette player for rehearsal music.	_____
TBD	G/S-3	Brief CG/CO on conduct of the ceremony.	_____
C-10	G/S-1	Provide a copy of the "Narration" to the narrator.	_____
C-10	G/S-3	Ensure parade field is marked, coordinate with SgtMaj.	_____

Figure 15-5.--Ceremonial Checklist--Continued.

<u>DATE</u>	<u>SECTION</u>	<u>ACTION REQUIRED</u>	<u>REMARKS</u>
C-10	Supply	Complete issue of parade gear, i.e., swords, frogs, belts as required.	_____
C-10	G/S-4	Coordinate with Armory and Comdrs for drawing weapons for the ceremony and final rehearsal.	_____
C-7	G/S-1	Begin preparation of VIP seating chart.	_____
C-7 to C-1	G/S-3 SgtMaj	Conduct key personnel rehearsal.	_____
C-5	G/S-1	Ensure completion and pick up program from the Defense Printing Service.	_____
C-3	Designated Units	Provide a working party to prepare parade field.	_____
C-3	G/S-4	Set up fly tents, chairs, and bleachers.	_____
C-3	Designated Units	Provide escorts and ushers.	_____
C-3	G/S-1	Coordinate purchase and delivery of flowers by COs, SgtMajs, or retiree.	_____
TBD	Arty	Coordinate with SgtMaj for final placement of saluting battery.	_____
C-1	G/S-3 SgtMaj	Conduct an all hands rehearsal without band.	_____
C-1	G/S-3 SgtMaj	Conduct an inclement weather with key personnel if required.	_____
C-1	G/S-4	Ensure completion of mowing, trimming, police of area, and conduct an inspection.	_____
C-1	G/S-3 G/S-4	1500 rehearse traffic control plan with road guard detail and VIP parking escorts.	_____
C-1	G/S-1	Coordinate last minute changes to the seating chart.	_____
C-1	G/S-4	Make final coordination with civilian contractors for "Quiet Hours."	_____

Figure 15-5.--Ceremonial Checklist--Continued.

<u>DATE</u>	<u>SECTION</u>	<u>ACTION REQUIRED</u>	<u>REMARKS</u>
C-Day	G/S-4	Wipe down bleachers, setup cold water dispensers w/cups behind each seating area, and check police of area. Ensure parking lots are marked.	_____
C-Day	G/S-1	Take delivery of flowers for spouses.	_____
C-Day	G/S-4	Post traffic signs at designated intersections and road guards at appropriate time.	_____
C-Day	G/S-3	Ensure corpsman and ambulance are in place.	_____
C-Day	G/S-1	Label VIP seating area and brief ushers on duties to include those designated to deliver flowers, and tasked with VIP parking duties.	_____
C-Day	G/S-3	Make final decision on implementing weather plan. Make frost calls as required if implemented.	_____
C-Day	G/S-1	Have Marine designated for break-out briefed and standing by.	_____
C-Day	G/S-4	Ensure windows and shades in the buildings around the ceremony area are closed.	_____
H-30	Band	Pre-ceremony concert begins.	_____
H-15	COT/Staff	In position near the reviewing area.	_____
H-Hour	CG/CO	Ceremony begins.	_____

Figure 15-5.--Ceremonial Checklist--Continued.

MARINE CORPS DRILL AND CEREMONIES MANUAL

PART II: CEREMONIES

CHAPTER 16

REVIEWS

	<u>PARAGRAPH</u>	<u>PAGE</u>
GENERAL . . . . .	16000	16-3
ELEMENTS OF A REVIEW . . . . .	16001	16-3
DIFFERENCES BETWEEN A PARADE AND A REVIEW . . . . .	16002	16-3
COMMAND OF TROOPS . . . . .	16003	16-3
PREPARATIONS . . . . .	16004	16-4
FORMATIONS . . . . .	16005	16-4
FORMING FOR THE REVIEW . . . . .	16006	16-5
REVIEWING PARTY . . . . .	16007	16-6
SEQUENCE OF EVENTS FOR A REVIEW . . . . .	16008	16-7

FIGURE

16-1	TROOP FORMATIONS. . . . .	16-4
16-2	REVIEWING PARTY . . . . .	16-6
16-3	FORMATION ON THE LINE OF TROOPS AND BAND MOVEMENT . . . . .	16-8
16-4	ADJUTANT TAKES POST . . . . .	16-9
16-5	ADJUTANT, COMMANDER OF TROOPS AND STAFF MOVE TO CENTER OF FIELD . . . . .	16-10
16-6	ROUTE OF MARCH FOR THE INSPECTING PARTY . . . . .	16-14



MARINE CORPS DRILL AND CEREMONIES MANUAL

PART II: CEREMONIES

CHAPTER 16

REVIEWS

16000. GENERAL. Reviews, when practicable, are held on the following occasions:

1. The presentation of United States or foreign decorations.
2. The decoration of organizational colors.
3. The retirement of an individual or group of any rank. Local commanders should consider it appropriate, when only one distinguished individual is retiring, to allow that individual to participate as the reviewing officer.

16001. ELEMENTS OF A REVIEW. A review consists of four parts:

1. Formation of troops.
2. Presentation of the command to the reviewing official. This includes an inspection of the troop formation (trooping the line).
3. Presentation of decorations and retirements.
4. March in review.

16002. DIFFERENCES BETWEEN A PARADE AND REVIEW

1. The sequence of events for a parade contains the following elements that a review does not contain.
  - a. March on of troops (optional for a review).
  - b. "Sound Off."
  - c. Manual of arms.
  - d. Receive the report.
  - e. Officers center.
2. The sequence of events for a review contains an inspection (trooping the line) and a parade does not.

16003. COMMAND OF TROOPS. The senior officer taking part in a ceremony is designated as the commander of troops. The commander of troops is responsible for the formation, presentation, and march in review. When a commander reviews the troops, the commander designates another officer as commander of troops. When the review is given for an important visitor or senior commander, the local commander designates another officer as commander of troops so the local commander may accompany the visitor or senior officer during the review.



16004. PREPARATIONS. The line on which troops are to form and along which they are to march is marked out or otherwise designated by the sergeant major or senior enlisted of the unit. The post of the reviewing officer, opposite the center of the line of troops, is marked on each flank with a dress guidon. Chapter 15 shows examples of the minimum marking for parades and reviews.

16005. FORMATIONS

1. The troops may be formed prior to the start of a review or marched on at the beginning of the review. Troops form in line for a review. Battalions and regiments may form in line with companies in line or with companies in mass formation. (See chapters 11 and 12.) When space is limited, for reviews conducted by regiments and larger organizations, the formation may be in line with battalions and independent companies in mass formation. Such formations may be modified when necessary because of space available or other exceptional circumstances. The initial formation will also influence the formation in which troops are to march in review. (See figure 16-1.)

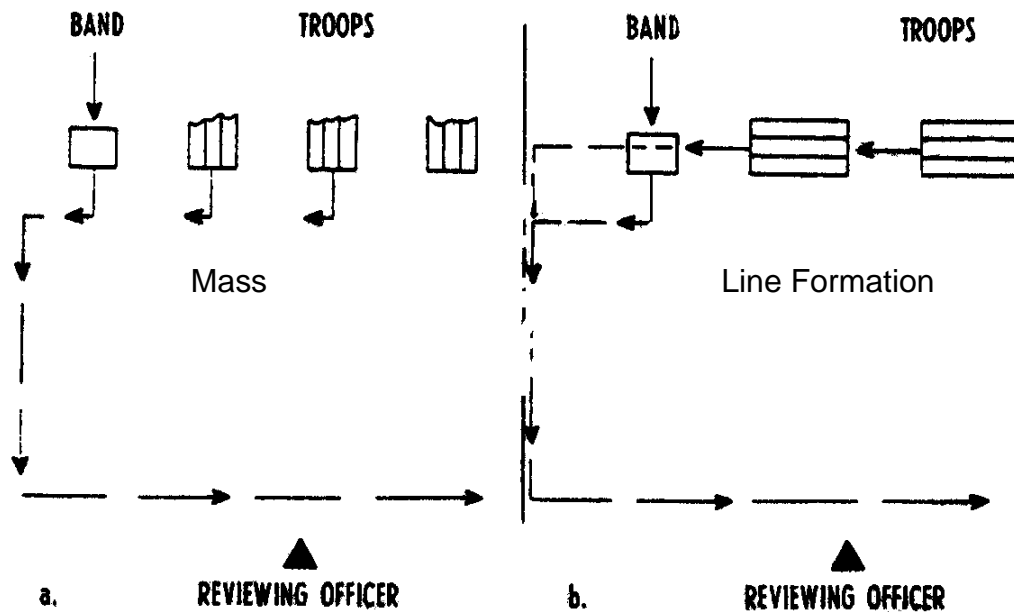

Figure 16-1.--Troop Formations.

2. In reviews involving two or more arms or types of organizations, troops are arranged as directed by the commander of troops. The following order, from right to left in line, may be used as a guide: infantry units, artillery, tanks, and motorized or service units. The provisions of paragraph 15001 also apply in reviews consisting of units from different services of the United States or foreign nations.

3. Arrangements should be made to provide for forming normal march columns after passing in review. An area should be designated where this can be accomplished without blocking the line of march of units that have not yet passed in review. Unless otherwise directed by the commander of troops, after passing in review, units revert to the control of their respective commanders.

16006. FORMING FOR THE REVIEW

1. Forming for a Battalion or Regimental Review. Initial forming for a review for a battalion or regiment with a march on is conducted per provisions of chapters 11 and 12.

a. If the unit is marched on at the beginning of the review, the sequence of events is the same as for a parade up to and including the adjutant's command of guide's post. The next step in the sequence would be for the adjutant to present the command to the commander of troops. The sequence would continue as in paragraph 16008.1.

b. If the unit is formed prior to the start of a review use the sequence of events in paragraph 16008.2.

c. Prior to presenting the command to the commander of troops the colors may be trooped as described in paragraph 7306.

d. If not at an evening review including "Retreat," after the command has been presented to the commander of troops and the staff boxed the reviewing officer will assume the designated position.

→ e. If at an evening review including "Retreat," after the command has been presented to the commander of troops and returned to order arms, the staff is not boxed. Instead, the commander of troops commands "**Present, ARMS,**" then when all troops are at present arms, commands "**SOUND RETREAT**" (or gives a prearranged signal to the band) at the time prescribed for evening colors. The band plays "Retreat" and then the "National Anthem" immediately afterwards. The flag is lowered during the "National Anthem" as prescribed in 7003. The commander of troops and the staff face the formation throughout this portion of the sequence. After the last note of the "National Anthem" the commander of troops and staff terminate their salutes and the commander of troops commands "**Order, ARMS.**" The staff is then boxed and the review continues as outlined in paragraph 16008.

Note: To conduct retreat as part of an evening review, troops must be formed in sufficient time prior to sunset to permit the command to be presented and evening colors to be conducted at the proper time.

2. Forming for Large Reviews

a. For reviews conducted by organizations larger than a regiment, such as a division, the same basic commands, procedures, and sequence of events prescribed above for a battalion or regimental review apply.

b. Normally, in large reviews battalions and independent companies are in mass formation. Troop units take their positions on the line of troops prior to the third "Adjutant's Call" being sounded to form for the review. In this regard, at the second "Adjutant's Call," regiments may be formed, presented to their commanders, and reports received at their designated locations, or the second "Adjutant's Call" may be conducted so that the regiments are formed at their positions on the line of troops for the review. Regardless, in large reviews, the commander of troops should prescribe the routes of march and arrival and departure times. If the frontage of the unit has been measured and marked, they may arrive

Enclosure (1)

independently in any convenient order to occupy their places on line. If this is not done, units must form in succession from the right. Because of the time consumption involved in the latter method, the former is preferred.

c. The commander of troops and adjutant of reviews conducted by organizations larger than a regiment give commands in the same manner as prescribed for a regiment in chapter 12, i.e., in a manner which does not require execution by the troops. In formations consisting of two or more regiments, the regimental commander repeats those commands requiring execution by the troops. Within each regiment, battalions and independent companies execute movements on the command of execution of their respective commanders. Independent battalions not part of a regiment, execute movements on the command of their respective commanders. Movements are executed successively by units from right to left.

#### 16007. REVIEWING PARTY

1. After the staff has been boxed and the commander of troops has faced the reviewing area (see paragraph 16008.3k), the reviewing officer, with the staff (if applicable), moves into position to receive the review.
2. The local commander, distinguished civilians, and the officer and enlisted staff take positions at their posts (see figure 16-2) facing the troops. The officer, who is senior, with the staff, will take position on the right.
3. An officer from the local commander's staff is designated to escort distinguished civilians to their positions. If a civilian is to receive the review, the civilian takes position on the right of the local commander. If necessary, the civilian is given an explanation of the ceremony by an escort or the local commander.

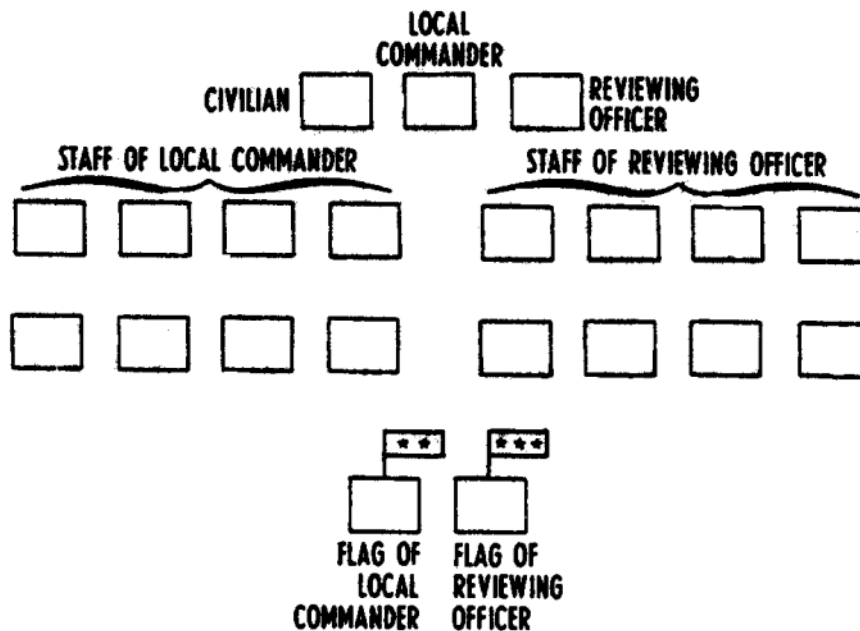

Figure 16-2.--Reviewing Party.

16008. SEQUENCE OF EVENTS FOR A REVIEW

1. March on for a Review. The organization is formed in the staging area. Troops are at parade rest; officers and noncommissioned officers have swords drawn, if so armed.

a. The organizational/review staff is in position near the reviewing stand.

b. For regimental reviews, battalion adjutants take their position behind the line of troops, swords drawn and at parade rest.

c. At H Hour-15 the narrator introduces the band. The band begins pre-review concert.

**NARRATOR: "LADIES AND GENTLEMEN, TODAY'S MUSIC IS PROVIDED BY THE \_\_\_\_\_ BAND UNDER THE DIRECTION OF \_\_\_\_\_. THE DRUM MAJOR IS \_\_\_\_\_."**

d. At H Hour-5 the band moves to its position on the right of line, countermarches and halts as shown in figure 17-1.

e. The commander of troops forms the staff per chapter 14.

f. At H-Hour the narrator makes opening remarks.

**NARRATOR: "GOOD MORNING (EVENING), LADIES AND GENTLEMEN. ON BEHALF OF THE COMMANDING OFFICER (GENERAL), \_\_\_\_\_, WELCOME TO THE \_\_\_\_\_ CEREMONY. TODAY'S REVIEW IS BEING EXECUTED BY THE OFFICERS AND MARINES OF \_\_\_\_\_."**

(Optional) **"LADIES AND GENTLEMEN, PLEASE RISE FOR THE INVOCATION BY COMMAND CHAPLAIN \_\_\_\_\_, UNITED STATES NAVY."**

g. Invocation is given.

(Note: After the invocation) **"LADIES AND GENTLEMEN PLEASE BE SEATED."**

h. Commander of troops commands **"TAKE YOUR POST."**

i. The adjutant moves by the most direct route to position on the line of troops. (See figure 17-2.)

→ Note: At this time, depending on the formation, the command may choose to have the narrator read verbiage similar to the following:

**NARRATOR: (AS THE ADJUTANT MOVES INTO POSITION) "PRESENT DAY REVIEWS IN THE MARINE CORPS HAVE THEIR BASIS IN BOTH HISTORY AND TRADITION, THE MASSED FORMATION OF TROOPS ON ONE LONG LINE AT CLOSE INTERVAL, MADE POSSIBLE THE MASSING OF FIREPOWER FROM MUZZLE LOADED MUSKETS OF YESTERDAY. IN THOSE EARLY DAYS, THE LINE OF BATTLE WAS JUST THAT, A LINE OF TWO OR THREE RANKS, AND LOOKED MUCH LIKE THE PARADE FORMATION YOU WILL SEE TODAY. THE ADJUTANT FORMS THE LINE FOR BATTLE."**

j. At this point follow the procedures to form a battalion for march on see chapter 11 and to form a regiment see chapter 12.

k. After the unit is formed the guides post. The procedures for a review in paragraph 16008.3 are followed.

Enclosure (1)

2. Units Formed on the Line of Troops Prior to the Start of the Review. The battalion is formed on the line of troops. Alignment is obtained and the unit is placed at parade rest. (See figure 16-3.)

a. At H Hour-15 the battalion staff is in position near the reviewing stand. The narrator introduces the band. The band begins pre-review concert.

→ b. At H Hour-5 the band moves to its position 12 paces to the right of the extreme right unit on the line of troops. (See figure 16-3.)

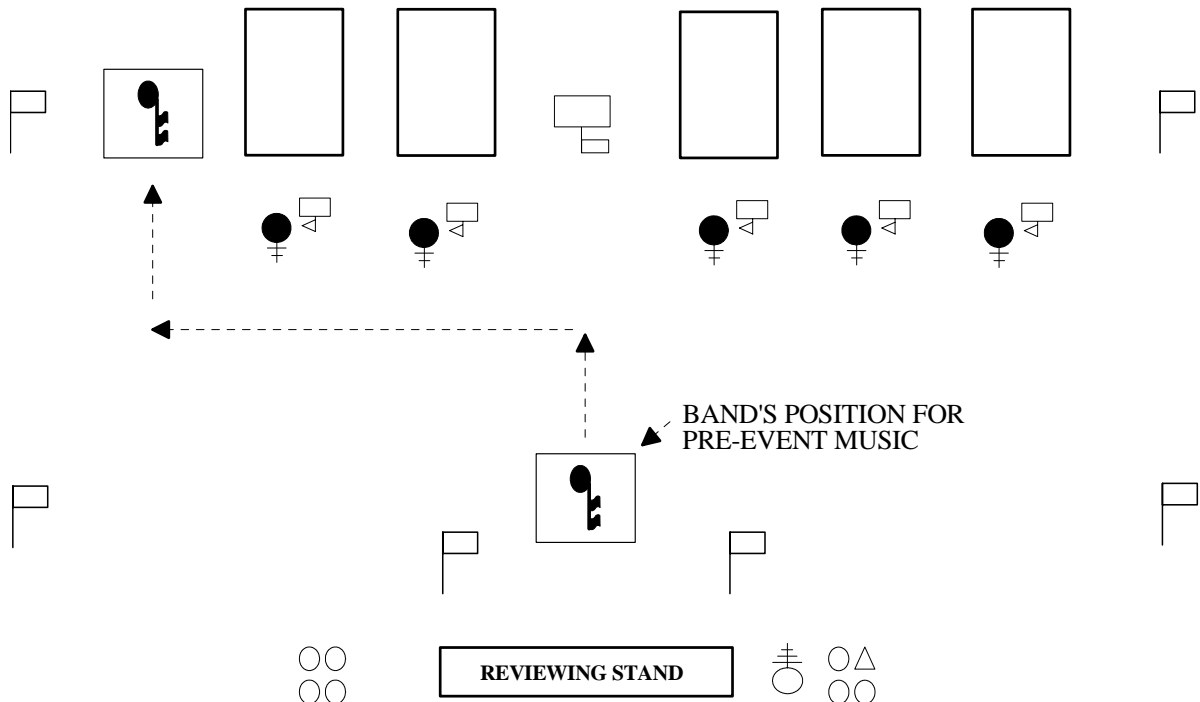

Figure 16-3.--Formation on the Line of Troops and Band Movement.

c. The commander of troops moves to a position centered between the dress guidons, halts, faces the reviewing stands and commands "**Staff, FALL IN.**" The staff moves smartly to their positions. (See figure 14-2.) Once the staff is in position the commander of troops faces about towards the line of troops.

**NARRATOR: "GOOD MORNING (EVENING), LADIES AND GENTLEMEN. ON BEHALF OF THE COMMANDING OFFICER (GENERAL), \_\_\_\_\_, WELCOME TO THE \_\_\_\_\_ CEREMONY. TODAY'S REVIEW IS BEING EXECUTED BY THE OFFICERS AND MARINES OF \_\_\_\_\_."**

**(Optional) "LADIES AND GENTLEMEN, PLEASE RISE FOR THE INVOCATION BY COMMAND CHAPLAIN \_\_\_\_\_, UNITED STATES NAVY."**

d. Invocation is given.

(Note: After the invocation) "**LADIES AND GENTLEMEN PLEASE BE SEATED.**"

e. Commander of troops commands "**TAKE YOUR POST.**"

Enclosure (1)

f. The adjutant moves by the most direct route to position on the line of troops. Once in position the adjutant faces down the line of troops, draws sword and commands. (See figure 16-4.)

**NARRATOR: (AS THE ADJUTANT MOVES INTO POSITION) "PRESENT DAY REVIEWS IN THE MARINE CORPS HAVE THEIR BASIS IN BOTH HISTORY AND TRADITION, THE MASSES FORMATION OF TROOPS ON ONE LONG LINE AT CLOSE INTERVAL, MADE POSSIBLE THE MASSING OF FIREPOWER FROM MUZZLE LOADED MUSKETS OF YESTERDAY. IN THOSE EARLY DAYS, THE LINE OF BATTLE WAS JUST THAT, A LINE OF TWO OR THREE RANKS, AND LOOKED MUCH LIKE THE PARADE FORMATION YOU WILL SEE TODAY. THE ADJUTANT FORMS THE LINE FOR BATTLE."**

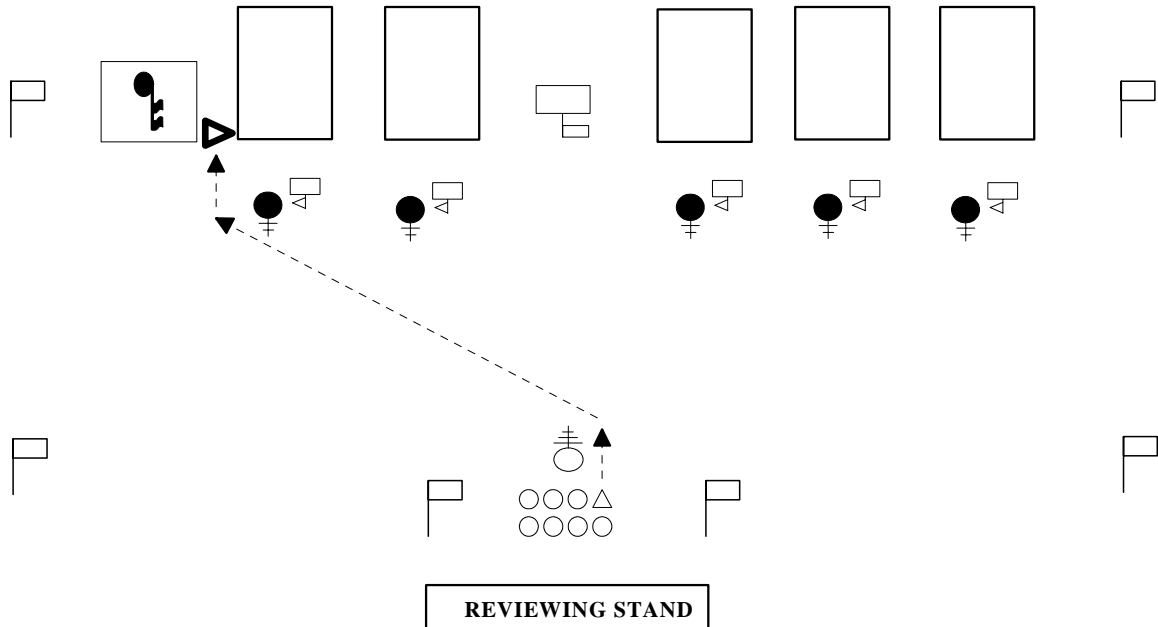

Figure 16-4.--Adjutant Takes Post.

- g. Adjutant commands "**SOUND ATTENTION.**"
- h. The company commanders execute attention, face their companies and in sequence command.
- i. Company commander commands "**Company, ATTENTION.**"
- j. The companies execute the commands. When all companies are at attention the adjutant commands.
- k. Adjutant commands "**SOUND ADJUTANT'S CALL.**"
- l. On the first beat of the music after "*Adjutant's Call*" the commander of troops and staff march to their position on the parade field and halt facing the line of troops. (See figure 16-5.) Once the units have been formed on the line of troops and the command "**Guides, POST,**" has been given (see chapter 11) the adjutant moves to a position 3 paces and centered on the commander of troops and facing the line of troops.

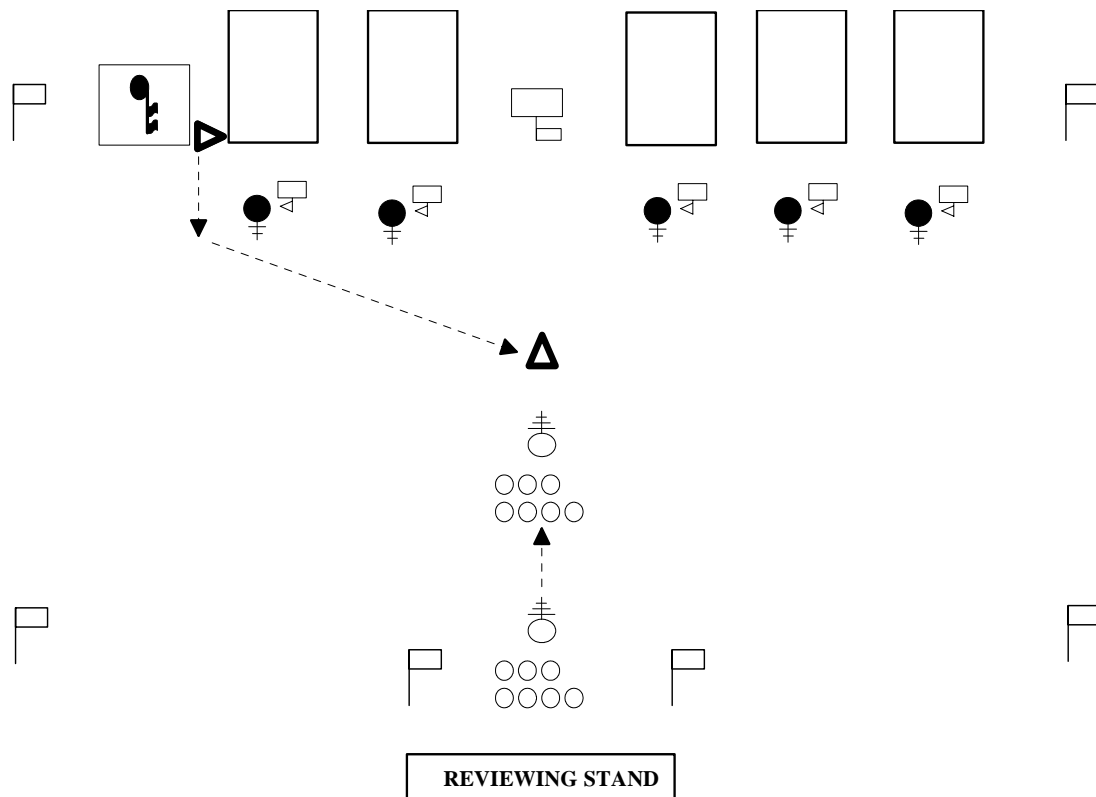

Figure 16-5.--Adjutant, Commander of Troops and Staff Move to Center of Field.

Note: The sequence of events is continued in paragraph 16008.3. It is at this point in time that the sequence of events, whether the troops are pre-staged or marched on is the same.)

### 3. Presentation and Honors

a. Adjutant commands **"Present, ARMS."**

b. Battalion executes. The color guard riflemen execute present arms, however, the organizational color does not present to the commander of troops. The adjutant then faces the commander of troops, presents sword and reports;

c. Adjutant commands **"SIR/MA'AM THE REVIEW IS FORMED."**

d. The commander of troops returns the adjutant's salute and directs the adjutant.

e. Commander of troops commands **"TAKE YOUR POST SIR."**

→ f. The adjutant executes carry sword, moves to position in the staff, halts, faces the line of troops and goes to order sword. Once the adjutant has halted, the commander of troops commands **"Staff, Draw, SWORD"** and **"Staff, Order, SWORD."**

Enclosure (1)

16-10

Ch 1

- g. The commander of troops then commands the battalion to **"Order, ARMS."**
- h. The battalion executes.
- i. Commander of troops commands **"BOX THE STAFF."**
- j. The adjutant moves the staff to its new position using the following commands: **"Staff, Carry, SWORD;" "Staff, Left, FACE;" "Column Right, MARCH;" "Staff, HALT;" "Staff, Right, FACE;"** and **"Staff, Order, SWORD."**
- k. After the staff is in position the unit commander and/or reviewing officer takes position in the reviewing area. The commander of troops then commands **"Present, ARMS."**
- l. The battalion executes. The color guard riflemen execute **"Present, ARMS."** The organizational color bearer presents colors when and if appropriate. The commander of troops then faces the reviewing area and commands **"Staff, Present, SWORD."**
- m. Staff and commander of troops execute. Musical honors and/or gun salutes are fired if appropriate. The unit commander and/or reviewing officer return the salute. After the last note of musical honors, or the final gun salute, the commander of troops commands **"Staff, Order, SWORD."**
- n. Staff executes. Commander of troops returns to the carry. The commander of troops then faces the line of troops and commands **"Order, ARMS."**

#### 4. Inspection

- a. Battalion and colors execute. The commander of troops then commands **"Parade, REST."**
- b. Battalion and colors execute. The band remains at attention. The commander of troops then faces the reviewing area and goes to order sword. The unit commander and/or reviewing officer (inspecting party) then move forward to the commander of troops.
- c. The commander of troops presents sword and reports **"SIR/MA'AM, THE BATTALION IS FORMED FOR INSPECTION."**
- d. The unit commander and/or reviewing officer returns the salute. The commander of troops terminates the salute and then executes return sword.
- e. The inspecting party and commander of troops step off towards the extreme right flank (normally the band) of the formation. They march as one rank with the senior member of the inspecting party on the right and the commander of troops on the left.
- f. If the inspection is to be made in vehicles, the reviewing party embarks at the post of the reviewing officer. The reviewing officer enters first and occupies the left rear position. The unit commander occupies the right rear position. The



vehicle then moves to the commander of troops position, approaching from the left, and stops. The commander of troops then salutes, reports, returns sword, and enters the vehicle in the right front position. The adjutant would then command the staff, "**Staff, Parade, REST.**" (Figure 16-6 shows the route of march for the inspecting party.)

g. Band plays martial music during the inspection.

h. When the inspecting party reaches the right flank of the formation they change order of precedence from left to right (reviewing officer, unit commander, commander of troops).

i. The inspecting party marches down the line of company commanders.

Note: If the formation is a company line formation the inspecting party would march down the line of platoon commanders.

j. As the inspecting party approaches the left flank of the company the company commander goes to carry sword, faces the company and commands "**Company, ATTENTION.**"

k. Company executes. The company commander then commands "**Eyes, RIGHT.**"

l. Company executes. The company commander then faces front and quietly commands the guide to "**Eyes, RIGHT.**" The company commander presents sword, the guide presents guidon and both execute eyes right. Except for the commander, other officers and noncommissioned officers in the formation who are armed with swords remain at the order during eyes right.

(1) As the inspecting party moves across the member's front, each Marine turns their head and eyes to the left, following the inspecting party, until their head and eyes are to the front. Each Marine then stops the movement of their head and eyes and remains at attention.

(2) After the inspecting party has cleared the left flank of the company the company commander quietly gives the command of "**Order, ARMS**" to the guide.

(3) The company commander then executes carry sword, faces the company and commands "**Parade, REST.**"

m. Company executes. Guide and company commander executes. The company commander remains facing the company.

(1) This process is repeated by each subsequent company commander.

(2) The inspecting party continues to move down the line of company commanders, saluting each company commander as they pass.

(3) The inspecting party salutes the colors as they pass in front of (but not behind) the colors.

(4) The color guard executes eyes right on the command of eyes right by the color company's company commander, however, only the organizational color bearer and left rifleman turn their head and eyes.

(5) After passing the left flank of the formation the inspecting party turns left and marches behind the formation. The last company commander does not give the command of parade rest until the inspecting party has passed behind his/her company.

n. As the inspecting party approaches the rear of each company the company commander commands **"Company, ATTENTION."**

o. The company executes. Once the inspecting party has cleared the companies rear the company commander commands **"Parade, REST."**

p. The company executes. The company commander then faces the reviewing area and goes to order sword and parade rest. This process is repeated by each subsequent company commander.

q. After the inspecting party completes passing around the rear of the formation the commander of troops moves to a position 3 paces in front of and 1 pace to the right of the band, draws sword and waits for the inspecting party to critique the inspection.

r. When the commander of troops is in position the reviewing officer and/or unit commander moves to a position 3 paces in front of and facing the commander of troops. The reviewing officer and/or unit commander and commander of troops exchange salutes.

s. The reviewing officer and/or unit commander then moves back to their position in the reviewing area. The commander of troops returns to a position in front of the staff.

t. The adjutant, seeing the commander of troops returning to position calls the staff to attention.

u. When the commander of troops arrives at the position in front of the staff, halts and faces the line of troops waits for the band to stop playing and commands **"Battalion, ATTENTION."**

v. Band stops playing.

w. The battalion executes. The commander and/or reviewing officer moves to their position in the reviewing area. The commander of troops then commands;

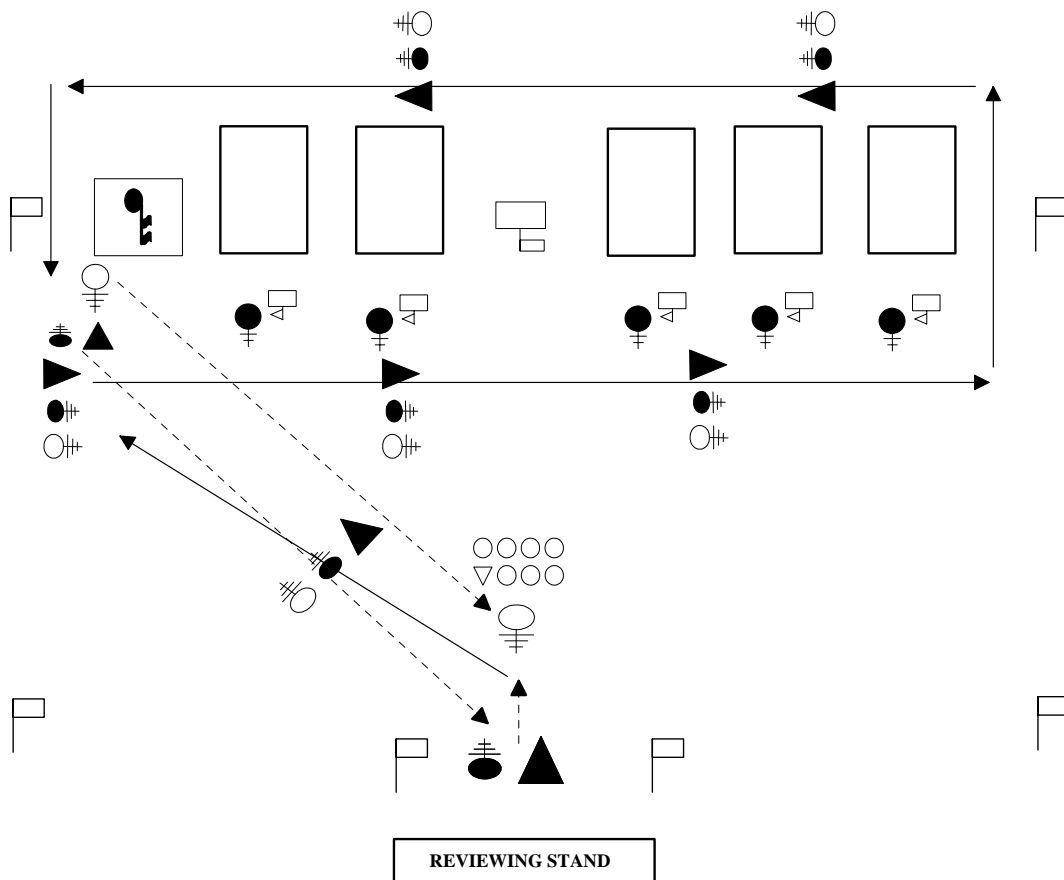

Figure 16-6.--Route of March for the Inspecting Party.

5. Note. At this time if:

a. The review is being held as an awards/retirement ceremony, go to chapter 18 and follow the sequence of events specified for the presentation of awards/retirement.

b. The review is being held for a change of command ceremony go to chapter 19 and follow the sequence of events specified for a change of command.

c. The review is being held for a relief and appointment of the sergeants major go to chapter 20 and follow the sequence of events specified for the relief and appointment of the sergeant major.

d. The review is being held for an activation or deactivation go to chapter 21 and follow the sequence of events specified for the activation or deactivation of a unit.

e. After completing one of the above sequences of events return to this Chapter and continue as follows.

6. March in Review

a. Unit commander/reviewing officer commands "MARCH THE COMMAND IN REVIEW."

b. The commander of troops faces the line of troops and commands "PASS IN REVIEW."

c. The unit marches in review as described in chapter 17, paragraphs 17007, 17008, 17009, and 17010. After the last element has marched in review, and the band and parade staff have cleared the field the narrator has announced the conclusion of the parade.

**NARRATOR: "LADIES AND GENTLEMEN THIS CONCLUDES THIS EVENING'S REVIEW. ON BEHALF OF THE COMMANDING OFFICER (GENERAL) AND THE OFFICERS AND MARINES OF THE \_\_\_\_\_, THANK YOU FOR YOUR ATTENDANCE."**

MARINE CORPS DRILL AND CEREMONIES MANUAL

PART II: CEREMONIES

CHAPTER 17

PARADES

	<u>PARAGRAPH</u>	<u>PAGE</u>
GENERAL . . . . .	17000	17-3
FORMATIONS . . . . .	17001	17-3
COMMANDER OF TROOPS . . . . .	17002	17-4
PREPARATION . . . . .	17003	17-4
SEQUENCE OF EVENTS, PRE-PARADE SERENADE THROUGH THE ADJUTANT TAKING POST . . . . .	17004	17-4
SEQUENCE OF EVENTS FOR FORMING A BATTALION AND LARGER UNITS .	17005	17-6
SEQUENCE OF EVENTS FOR PRESENTATION OF THE COMMAND . . . . .	17006	17-8
SEQUENCE OF EVENTS TO MARCH IN REVIEW IN COLUMN FROM A BATTALION LINE, COMPANY LINE FORMATION. . . . .	17007	17-13
SEQUENCE OF EVENTS TO MARCH IN REVIEW IN COLUMN FROM A BATTALION LINE, COMPANY MASS FORMATION. . . . .	17008	17-16
SEQUENCE OF EVENTS TO MARCH IN REVIEW IN BATTALION COLUMN, COMPANY MASS FORMATION . . . . .	17009	17-18
TO MARCH IN REVIEW, COMPANIES IN A COLUMN OF PLATOONS IN LINE	17010	17-21
REGIMENTAL PARADES . . . . .	17011	17-22
BATTALION AND REGIMENTAL FORMATIONS . . . . .	17012	17-25
STREET PARADES . . . . .	17013	17-26

FIGURE

17-1	MOVEMENT OF THE BAND. . . . .	17-5
17-2	ADJUTANT MOVES TO POST . . . . .	17-6
17-3	SOUND OFF . . . . .	17-7
17-4	OFFICERS CENTER . . . . .	17-9
17-5	POST MARCH. . . . .	17-11
17-6	RIGHT FACE. . . . .	17-14
17-7	MARCH IN REVIEW, COMPANIES IN COLUMN. . . . .	17-15

MARINE CORPS DRILL AND CEREMONIES MANUAL

		<u>PAGE</u>
17-8	COLUMN OF THREES, FROM THE RIGHT. . . . .	17-18
17-9	MARCH IN REVIEW, COMPANIES IN MASS. . . . .	17-19
17-10	MARCHING IN REVIEW, COMPANIES IN COLUMN OF PLATOONS ON LINE. . . . .	17-21
17-11	REGIMENTAL OFFICERS CENTER . . . . .	17-23
17-12	REGIMENTAL MARCH IN REVIEW . . . . .	17-24

MARINE CORPS DRILL AND CEREMONIES MANUAL

PART II: CEREMONIES

CHAPTER 17

PARADES

17000. GENERAL. The appearance and movement of troops in formation are the primary considerations of a ceremonial parade. The preparation, organization of troops, and the conduct of a ceremonial parade require familiarity with those chapters for platoon, company, battalion, and regimental drill as well as organizational and parade staff. Normally a parade consists of the following elements:

1. Pre-parade serenade by the band.
2. Forming the staff, and posting the adjutant.
3. March on and formation of the command (forming without a march on is optional).
4. Trooping the colors if appropriate for the type of ceremony.
5. "Sound Off" and trooping the line by the band.
6. The manual of arms.
7. Receiving reports and publishing orders by the adjutant.
8. Officer's center.
9. Presentation of the command and honors to the reviewing officer.
10. Presentation of awards, promotions, retirements, changes of command, relief and appointment of the sergeant major, etc.
11. March in review.
12. Additionally, bayonets may be fixed, if desired, and, at evening parade, retreat may be included as part of the ceremony.

17001. FORMATIONS

1. The battalion is formed per the procedures prescribed in chapter 11 and the regiment is formed per the procedures in chapter 12. The unit commander designates the formation for the parade.
2. The basic formations a commander may choose for battalion parades are:
  - a. Battalion line, company line. Used when space is available or when a larger front is desired for the line of troops.
  - b. Battalion line, company mass (extended mass). Used when the space available for the "front" for the line of troops is limited.

3. The basic formations a commander may choose for regimental parades are:

a. Regiment in line, battalions in line with companies in line or mass (extended mass) formation.

b. Regiment in line, battalions in mass (extended mass).

17002. COMMANDER OF TROOPS. The senior officer taking part in a ceremony is designated as the commander of troops. The commander of troops is responsible for the formation, presentation, and march in review. When a commander acts as the reviewing officer for the parade, the commander designates another officer as commander of troops.

17003. PREPARATION. The line on which troops are to form and along which they are to march is marked out or otherwise designated by the sergeant major or senior enlisted of the unit. The post of the reviewing officer, opposite the center of the line of troops, is marked on each flank with a dress guidon. Additionally, commander's posts, unit guide's posts, and turning points for the approaching the line of troops may also be marked. Paragraph 15007 of this Manual provides details for marking a parade field.

17004. SEQUENCE OF EVENTS, PRE-PARADE SERENADE THROUGH THE ADJUTANT TAKING POST

1. The sequence of events in this paragraph is the same for all parades, regardless of the size of the units participating. The sample LOI on the Marine Corps Drill website will include a sample narration woven into the sequence. Experience has proven this is the best way to keep the commander of troops, adjutant, narrator, etc., synchronized for the parade.

2. H-Hour-15 Minutes

a. The organization is formed in the assembly area. Troops are at parade rest; officers and noncommissioned officers have swords drawn, if so armed. There will be occasions when it will be desired or necessary to form the unit without a march on. In this case the battalion is formed at H-15 on the line of troops, alignment is obtained and the unit is placed at parade rest at which time the sequence continues as outlined in this Chapter.

b. The organizational/parade staff is in position near the reviewing stand.

c. For regimental parades, battalion adjutants take their position behind the line of troops, swords drawn and at parade rest.

d. Narrator introduces the band. The band begins pre-parade serenade.

**NARRATOR: "LADIES AND GENTLEMEN, THE MUSIC FOR TODAY'S PRE-PARADE SERENADE IS PROVIDED BY THE MARINE \_\_\_\_\_ BAND UNDER THE DIRECTION OF \_\_\_\_\_ . THE DRUM MAJOR IS \_\_\_\_\_."**

3. H-Hour-5 Minutes

a. The band moves to its position on the right of line, countermarches and halts. (See figure 17-1.)

→ b. The commander of troops forms the staff per chapter 14.

Enclosure (1)



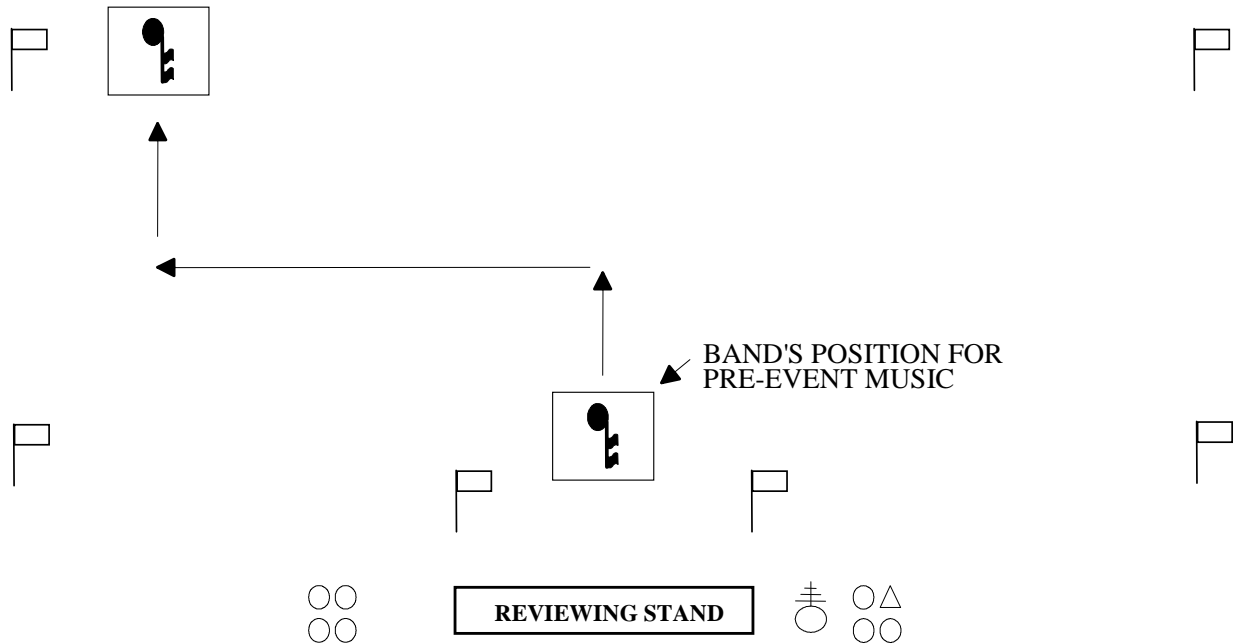

Figure 17-1.--Movement of the Band.

#### 4. H-Hour

- a. Narrator makes opening remarks.

**NARRATOR:** "GOOD MORNING (EVENING), LADIES AND GENTLEMEN. ON BEHALF OF THE COMMANDING OFFICER (GENERAL), \_\_\_\_\_, WELCOME TO THE \_\_\_\_\_ CEREMONY. TODAY'S PARADE IS BEING EXECUTED BY THE OFFICERS AND MARINES OF \_\_\_\_\_."

(Optional) "LADIES AND GENTLEMEN, PLEASE RISE FOR THE INVOCATION BY COMMAND CHAPLAIN \_\_\_\_\_, UNITED STATES NAVY."

- b. Invocation is given.

(Note: After the invocation) "LADIES AND GENTLEMEN PLEASE BE SEATED."

- c. Commander of troops commands "TAKE YOUR POST."

d. The adjutant moves by the most direct route to a position on the line of march. (See figure 17-2.)

➔ **NOTE:** at this time, depending on the formation, the command may choose to have the narrator read verbiage similar to the following:

**NARRATOR:** (AS THE ADJUTANT MOVES INTO POSITION) "PRESENT DAY PARADES IN THE MARINE CORPS HAVE THEIR BASIS IN BOTH HISTORY AND TRADITION, THE MASSED FORMATION OF TROOPS ON ONE LONG LINE AT CLOSE INTERVAL, MADE POSSIBLE THE MASSING OF FIREPOWER FROM MUZZLE LOADED MUSKETS OF YESTERDAY. IN THOSE EARLY DAYS, THE LINE OF BATTLE WAS JUST THAT, A LINE OF TWO OR THREE RANKS, AND LOOKED MUCH LIKE THE PARADE FORMATION YOU WILL SEE TODAY. THE ADJUTANT FORMS THE LINE FOR BATTLE."

Enclosure (1)

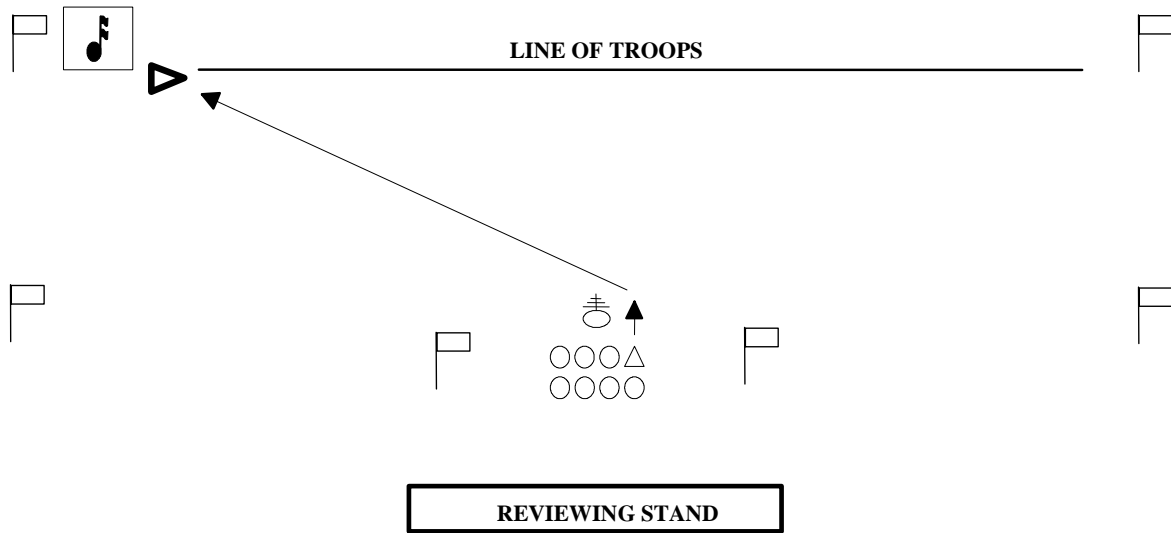

Figure 17-2.--Adjutant Moves to Post.

17005. SEQUENCE OF EVENTS FOR FORMING A BATTALION AND LARGER UNITS

1. To form a battalion for march on see chapter 11.
2. To form a regiment see chapter 12
3. Color Guard

a. If awards, retirements, etc., are a part of the parade the color guard will march onto the parade field with the battalion, when approaching its position on the line of march the color guard will execute a left turn, march forward to their position in the line of troops, mark time, halt and go to order colors. The color guard will execute all commands with the color company except that it will remain at the order during the manual of arms.

b. If no awards, retirements, etc., are a part of the parade and the commander wants to "troop the colors" the color guard would execute a left turn at the extreme left edge of the parade field. It then marches to a position on the left flank of the field, half way between the line of company commanders and the adjutant's position. The color guard executes a right turn and goes to order colors. (See paragraph 7306.)

4. Upon completion of forming the unit and if prescribed for the ceremony, the adjutant next commands "**Fix, BAYONETS.**" After fixing bayonets, or after posting the guide if bayonets are not fixed, the adjutant continues the sequence from paragraph 17005.5 or 17005.9 below as appropriate.

Note: If colors are to be marched on continue the sequence with paragraph 17005.5 below. If colors are not to be marched on skip to paragraph 17005.9.

5. Adjutant commands "**MARCH ON THE COLORS.**" The band plays appropriate music while the color guard, goes to the carry, marches from its position on the left flank, across the front of the battalion along a line parallel to the line of troops and midway between the adjutant and line of company commanders. Company

commanders and the company guide salute the colors as they pass their front. On reaching a point in front of the adjutant, the color guard executes a left turn to face the adjutant and halts, remaining at the carry.

6. Adjutant commands **"Present, ARMS."** The battalion executes present arms. The adjutant salutes the colors.

a. The color guard executes present arms from the carry.

→ b. The band plays either "To the Color" or the "National Anthem." The commander of troops, the staff and the organizational colors salute on the first note of the music and terminate the salute on the last note.

7. Adjutant commands **"Order, ARMS."** The command executes order arms. The color guard returns to carry colors.

8. Adjutant commands **"POST THE COLORS."** The color guard countermarches, moves to the line of troops on the left of the color company, countermarches to face the front, halts, and goes to order colors.

9. Adjutant commands **"Parade, REST"** and **"SOUND OFF."** The battalion, except for the commander of troops, the staff and adjutant go to parade rest. The band sounds off, marches down the line of troops, countermarches, marches back down the line of troops and returns to its position in formation. Once the band is back in position and has stopped playing; (Figure 17-3 depicts the movement of the band during sound off.)

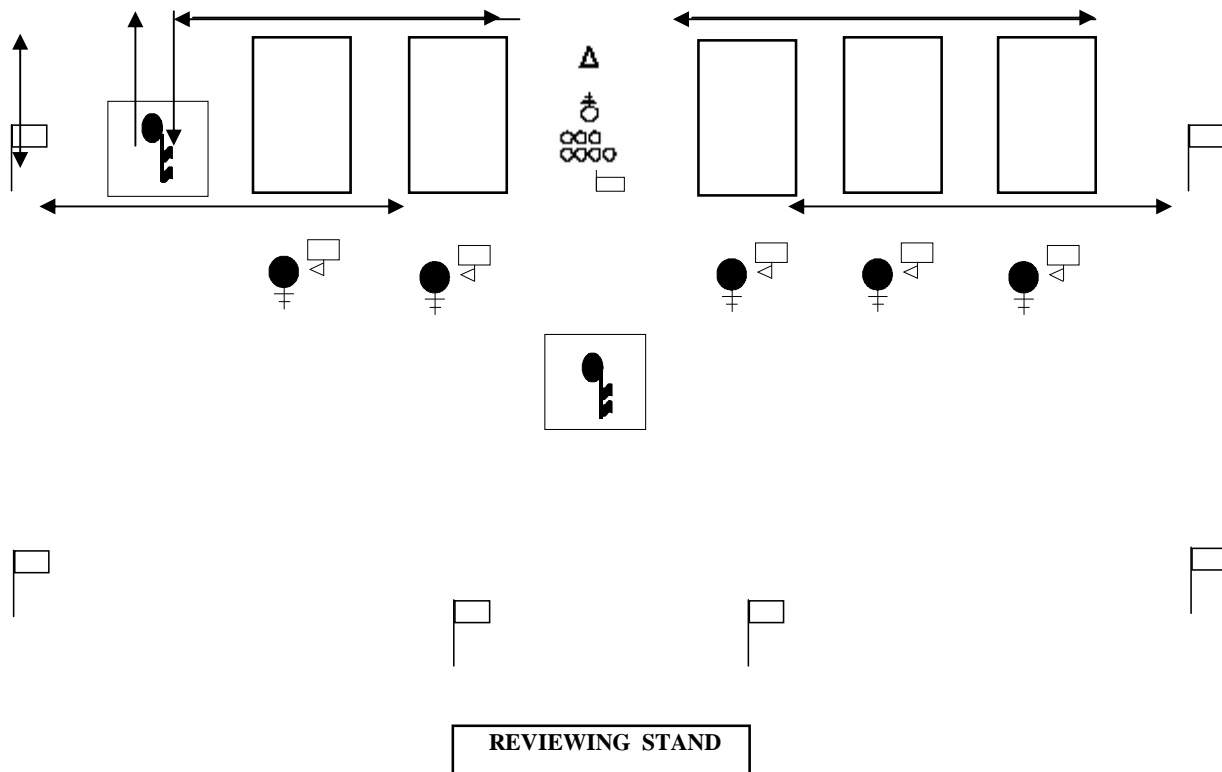

Figure 17-3.--Sound Off.

10. Adjutant commands **"Battalion, ATTENTION"** and **"Present, ARMS."** The battalion executes attention and present arms. The color guard riflemen execute present arms and the colors go to the carry. However, the commander of troops does not receive a salute from the organizational colors unless the commander of troops is the battalion commander or officer of higher rank. Once the battalion is at present arms the adjutant faces the commander of troops and reports.

17006. SEQUENCE OF EVENTS FOR PRESENTATION OF THE COMMAND

1. Adjutant reports **"SIR/MA'AM, THE PARADE IS FORMED."** The commander of troops returns the adjutant's salute.

2. Commander of troops commands **"TAKE YOUR POST."** The adjutant returns to carry swords and marches by the most direct route to the designated post in the staff, halts, faces the line of troops and goes to order sword.

→ 3. Commander of troops commands (only loud enough for the staff to hear) **"Staff, Draw, SWORD"** and **"Staff, Order, SWORD"** (omitted if not armed with swords). The commander of troops remains at carry sword. The commander of troops then exercises the battalion in the manual of arms.

4. Commander of troops commands **"Order, ARMS;" "Port, ARMS;" "Right Shoulder, ARMS;" "Port, ARMS;" "Left Shoulder, ARMS;" "Port, ARMS;"** and **"Order, ARMS."** The battalion executes the manual of arms on the orders of the commander of troops.

a. Company officers and noncommissioned officers execute carry swords of the first command of port arms and return to order swords on the final command of order arms.

b. The color guard remains at the order during the manual of arms.

5. After the manual of arms is completed the commander of troops directs the adjutant to **"RECEIVE THE REPORT, SIR/MA'AM."** The adjutant goes to carry sword and moves to a position 3 paces in front of the commander of troops, facing the line of troops.

6. Adjutant commands **"REPORT."** Company commanders, in succession, from right to left, salute the adjutant with their head and eyes to the front and report, **"\_\_\_Company, All Present or Accounted For."** The adjutant turns his/her head towards the company commander reporting, but returns the head to the front when returning each company commander's salute. After the last company has reported, the adjutant faces the commander of troops and reports **"Sir/Ma'am, All Present or Accounted For."** The commander of troops returns the adjutant salute, returns to carry sword (the commander of troops remains at carry sword, except when saluting, during the execution of officers center and officers posts).

7. Commander of troops commands **"PUBLISH THE ORDERS."** The adjutant terminates the salute, faces the line of troops and publishes the orders.

8. Adjutant commands **"ATTENTION TO ORDERS."** (Most commands use the following "orders." However, they may be modified to retirement, change of command, relief and appointment orders, etc., at the desire of the commander.)

Enclosure (1)

Note: "Headquarters, \_\_\_ Battalion \_\_\_ Marines, (date), (month), (year), The Officer of the day today is (rank and name), The Officer of the day tomorrow is (rank and name). By order of (battalion commander's rank and name), United States Marine Corps (Reserve), Commanding."

9. Adjutant commands "**OFFICERS**"--"**CENTER**"--"**MARCH.**" (A sufficient pause between the above command is necessary for the officers and guides to execute the movements.) Figure 17-4 depicts movement for officers center. On the command "**OFFICERS**" the company commanders and platoon commanders go to carry sword, if so armed. The company guide goes to carry guidon.

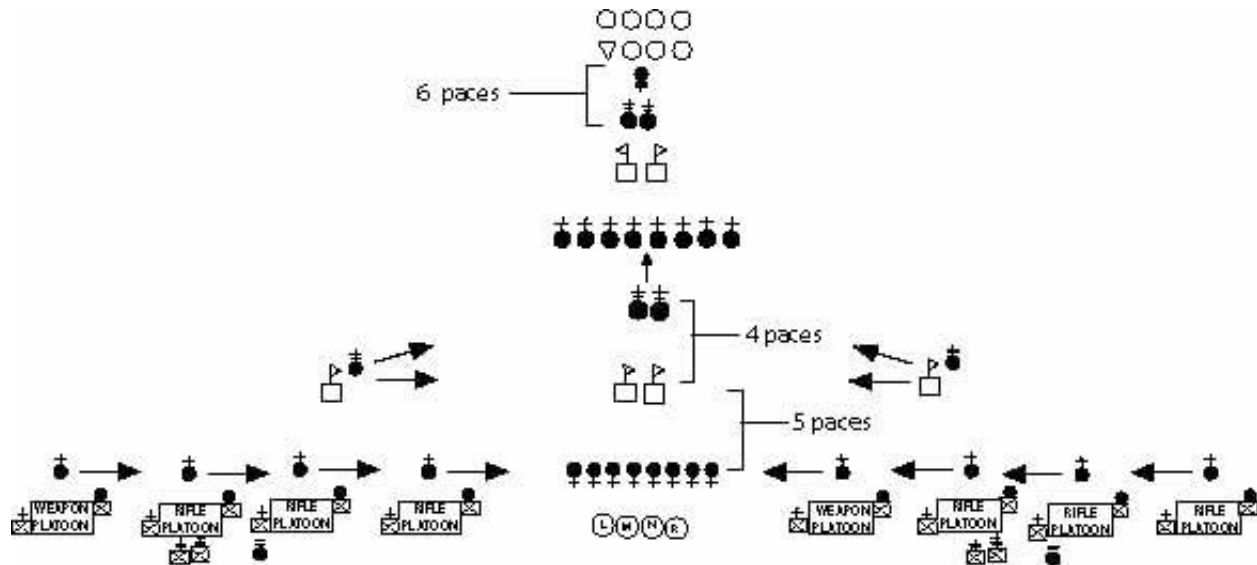

Figure 17-4.--Officers Center.

Note: If the parade is being conducted in conjunction with a review then officers center is omitted.

a. On the command "**CENTER.**"

(1) If in battalion line, company line, company commanders, platoon commanders and company guides face left/right towards the center of the parade field.

(2) If in a battalion line, company mass formation, company commanders and guides face left/right towards the center of the parade field. Platoon commanders take one step forward, halt and then face left/right towards the center of the parade field.

(3) Platoon guides stand fast.

b. On the command "**MARCH.**"

(1) The band starts playing.

(2) The adjutant returns by the most direct route to the designated position in the staff and goes to order sword.

(3) The platoon commanders and guides march directly to their positions in the center of the parade field halt and face left/right towards the commander of troops at close interval.

(4) The company commander's oblique slightly forward in order to form on a line approximately 4 paces in front of the line of guides.

→ 10. Once all officers and guides have halted and faced the commander of troops, the senior company commander commands, "**Officers, Forward, MARCH.**" As the ranks of officers and guides advance towards the commander of troops, alignment is maintained towards the center, with the officer in the center of the leading rank setting the step and direction.

11. As they approach the commander of troops the senior company commander commands "**Officers, HALT.**" The ranks of officers and guides are halted approximately 6 paces from the commander of troops and salute.

a. If armed with swords the officers and guides execute a four-count halt. On the first two counts, the officers and guides execute a halt. On the third count the officers execute the first count of present swords. For the fourth count the officers execute the second count of present swords and the company guides present guidons.

b. If not armed with swords, the officers and company guides execute a four-count halt. On the first two counts, the officers and guides execute a halt. On the third count all pause, and on the fourth count the officers execute a hand salute and the company guides present guidons.

→ c. The commander of troops returns the salute. The commander of troops terminates the salute on the same command which terminates those of the officers' party.

12. Commander of troops commands "**Carry, SWORD**" (If armed with swords) or "**Ready, TWO**" (If not armed with swords).

a. On the command "**Carry,**" the officers execute order swords, if so armed. The guides re-grasp the guidon as the first count of carry guidon. When not armed with swords on the command "**Ready,**" the officers stand-fast and guides re-grasp the guidon as the first count of carry guidon.

b. On the command "**SWORD (TWO)**" the officers go to carry swords, if so armed, and the guides go to carry guidon. If not armed with swords the officers cut their salute. The commander of troops then commands.

13. Commander of troops commands "**POST**"-"**MARCH.**" Figure 17-5 depicts post march.

a. On the command of "**POST,**" all officers and guides execute an about face.

b. On the command of "**MARCH,**" officers and guides step off and march back towards the battalion formation. Alignment is maintained towards the center, with the officer in the center of the leading rank setting the step and direction.

Enclosure (1)

17-10

Ch 1

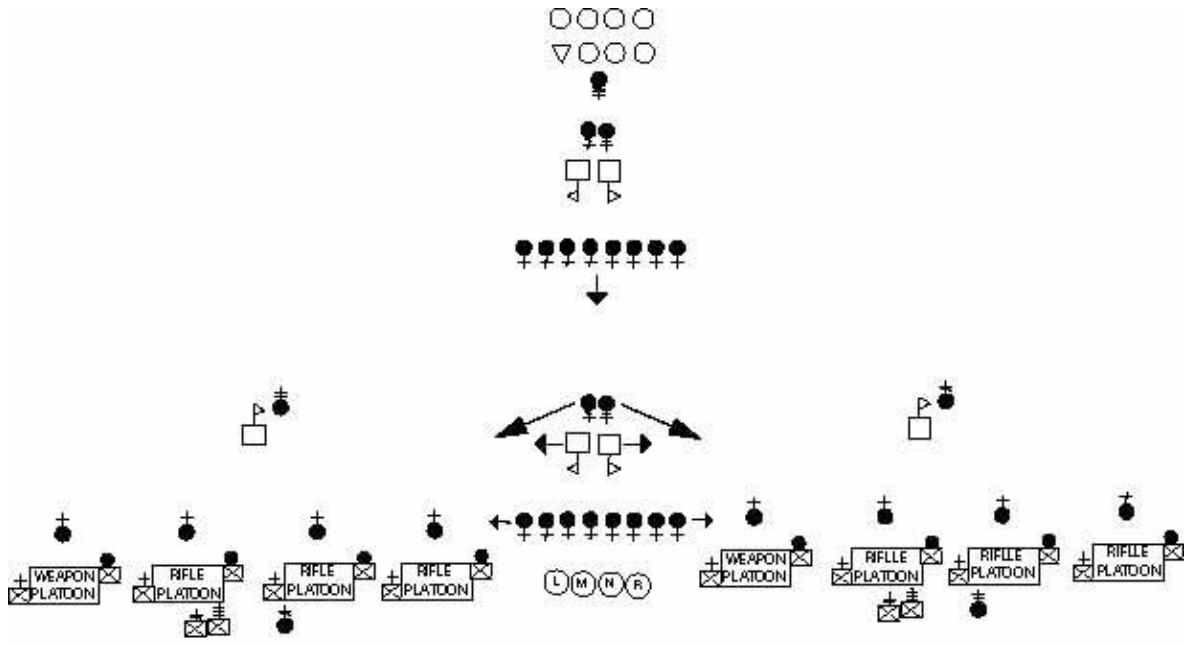

Figure 17-5.--Post March.

14. When the officers are nearing the battalion formation the senior company commander commands "**Officers, HALT;**" and "**POST--"MARCH."**" The officers are halted so that:

a. When in a battalion line, company line, and the rank of platoon commanders are 6 paces from the line of troops.

b. When in a battalion line, company mass, the rank of platoon commanders are 2 paces from the line of troops.

c. On the command of "**POST,**" all officers and guides face left/right in the direction of their companies.

d. On the command of "**MARCH,**" officers and guides step off in succession at 4-pace intervals. (The Marine at the head of each file steps off, then every fourth step the next Marine steps off so as to be in step with the music.) Then, by the most direct route, return to their posts, halt, face front and execute order swords.

→ (1) If in a company mass formation, upon reaching their platoons, the platoon commanders will execute one step to the right/left flank into their position, halt, about face and go to order sword.

(2) Guidon bearers step off with their company commander and when reaching their post, halt, face front and go to order guidon.

(3) Company commanders oblique inboard so that they are 1 pace in front of their guidon bearer upon reaching their post. They halt, face front and go to order swords.

e. When all officers and guides have returned to their posts, and gone to the order, the band stops playing. The commander of troops then, so only the staff can hear, commands.

Enclosure (1)

15. Commander of troops commands **"BOX THE STAFF."** (See paragraph 14002.3.)

a. The adjutant boxes the staff by giving the following commands;

(1) **"Staff, Carry, SWORD"** (if armed with swords).

(2) **"Staff, Left, FACE."**

(3) **"Staff, Column Right, MARCH"** (second column right is executed without command. Once each staff member has reached their new position they automatically mark time).

(4) **"Staff, HALT."**

(5) **"Staff, Right, FACE."**

(6) **"Staff, Order, SWORD"** (if armed with swords).

b. Once the staff is in its new position the commander of troops faces the reviewing area. The reviewing officer then takes position centered between the dress guidons at attention. The commander of troops, seeing the reviewing officer in position, faces the battalion.

Note: If the reviewing officer is a general or flag officer, or civilian that rates "honors" the following sequence will be used beginning with paragraph 17006.16. The procedures for honors and gun salutes are contained in chapter 22. If no musical or gun salutes are due to the reviewing officer skip to paragraph 17006.20.

**NARRATOR: "LADIES AND GENTLEMEN, PLEASE RISE FOR HONORS TO (TITLE/RANK AND NAME OF THE PERSON TO RECEIVE HONORS)."**

16. Commander of troops commands **"Present, ARMS."** The command executes present arms.

a. The color guard executes present arms from the order. If no musical or gun salute is fired the organizational colors salutes if appropriate. If musical or gun salutes are utilized the organizational colors salutes on the first note of music and returns to the carry on the last note of the music or last gun is fired.

b. Once the battalion is at present arms the commander of troops faces the reviewing area.

17. Commander of troops commands **"Staff, Present, SWORD (ARMS)."** The staff and commander of troops present swords. After honors, if any, the reviewing officer returns the salute of the commander of troops.

18. Commander of troops commands **"Staff, Order, SWORD (ARMS)."** The commander of troops and staff go to order swords. The commander of troops returns to carry sword and faces the battalion.

19. Commander of troops commands **"Order, ARMS."** The battalion executes order arms. The commander of troops then faces the reviewing area.



20. Note. At this time if:

a. The parade is being held as part of a review, refer to chapter 16 and follow that sequence of events.

b. The parade is being held as an awards/retirement ceremony, refer to chapter 18 and follow the sequence of events specified for the presentation of awards/retirement.

c. The parade is being held for a change of command ceremony refer to chapter 19 and follow the sequence of events specified for a change of command.

d. The parade is being held for a relief and appointment of the sergeants major refer to chapter 20 and follow the sequence of events specified for the relief and appointment of the sergeant major.

e. If the parade is being held for an activation/deactivation, or a joint activation/deactivation ceremony refer to chapter 21 and follow the sequence of events for the specific ceremony outlined there.

21. After completing one of the above sequences of events return to this Chapter and continue with the sequence of events for marching in review.

17007. SEQUENCE OF EVENTS TO MARCH IN REVIEW IN COLUMN FROM A BATTALION LINE, COMPANY LINE FORMATION

1. After completing the presentation of awards, retirements, etc., and the battalion is at attention, the commander of troops faces the reviewing officer.

→ 2. Reviewing officer commands "**MARCH THE COMMAND IN REVIEW.**" After exchanging salutes, the commander of troops commands "**Staff, Carry, SWORD,**" and then faces the line of troops.

3. Commander of troops commands "**PASS IN REVIEW**" and "**Right, FACE.**" While the battalion is being prepared to march in review band moves to its position on the line of march.

a. On the command "**PASS IN REVIEW,**" all personnel armed with sword will execute carry sword.

b. On the command of execution "**FACE,**" all hands face to the right. The platoon guides move to their position in front of the right squad. The platoon commanders move to their position at the head of their platoons. The company commanders and company guides then move to their positions at the head of their companies. (See figure 17-6.)

c. The color guard, on the command "**Right, FACE,**" goes to carry colors, executes a right turn, halts and remains at the carry.

4. Commander of troops commands "**Right Shoulder, ARMS.**" The battalion executes right shoulder arms. The commander of troops then glances in the direction of the band to ensure it is ready to march in review. The drum major signifies the band is ready by having halted the band and raising the mace in a high carry position.

Enclosure (1)

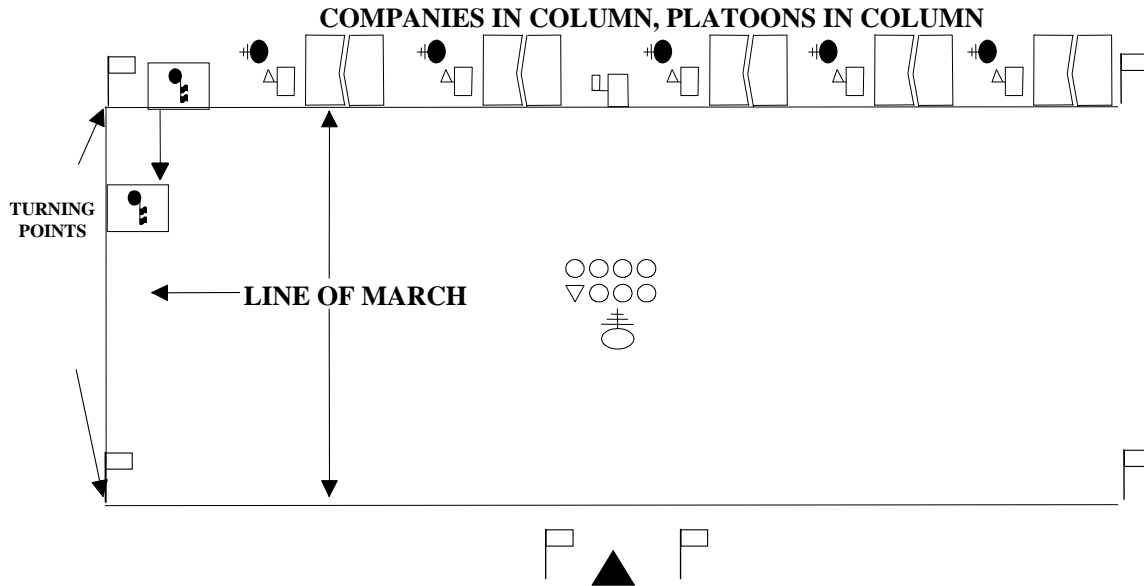

Figure 17-6.--Right Face.

- 5. Commander of troops commands **"Staff, Carry, SWORD"** and **"Forward, MARCH."** The entire battalion steps off and the band plays *"Semper Fidelis"*. The formation quickly adjusts its step so that the left foot strikes the deck in time with the heavy beat of the drum.
- a. The commander of troops and staff step off when the command of execution **"MARCH"** is given by the commander of troops. The commander of troops steps to the left in marching and picks up the half step. The staff executes a right turn from the halt, covers on the commander of troops and picks up the half step. When the staff has completed the turn the commander of troops commands **"Staff, Forward, MARCH."**
  - b. The commander of troops and staff marches down the line and execute two left turns in order to be positioned at the head of the column in front of the band. (See figure 17-7.)
  - c. The company commanders, as they approach each turning point give the command of **"Column Left, MARCH"** for themselves and the company guide. Platoon commanders give their platoons **"Column Left, MARCH"** in order to maintain their positions in the company column. (See figure 17-7.)
  - d. The color guard executes left turns at the turning points.
  - e. All column movements are made "inside" the line formed by the dress guidon. The platoon guides use the dress guidons as markers to set the direction of march for the platoon.
6. As the commander of troops, band, company commanders, platoon commanders and the color guard approach the reviewing area the command of eyes right will be given.

Enclosure (1)

17-14

Ch 1

a. As commander of troops and the staff approach the reviewing area the commander commands **"Staff, Eyes, RIGHT,"** as the reviewing area is cleared, **"Staff, Ready, FRONT."**

→ (1) The commander of troops and the staff continue to march down the line of troops to the end of the reviewing area, or other designated point, where they will turn out of the line of march and be positioned to observe the march in review (e.g., they may execute three right turns, see figure 14-8).

(2) The commander of troops, after the staff is halted, commands **"Staff, Return, SWORD,"** if so armed. The commander of troops gives the commands of **"Hand, SALUTE,"** and **"Ready, TWO,"** as the color guard passes the staff's position.

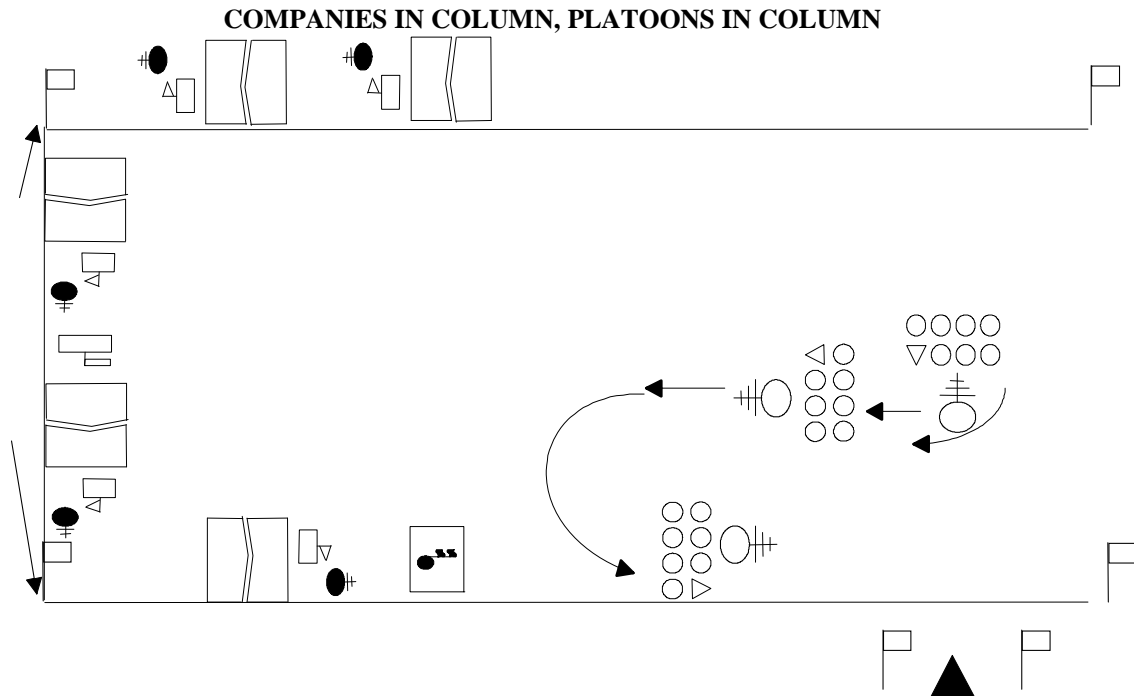

Figure 17-7.--March in Review, Companies in Column.

b. As the band passes the reviewing area the drum major executes an eyes right and salutes for the band. After clearing the reviewing area, the band is marched to a position approximately 30 paces from the reviewing area, centered on and facing the reviewing officer. The band continues to play march music during the march in review.

c. As each company commander approaches the reviewing area the commander gives the command of **"Eyes, RIGHT"** for themselves and the company guide. After passing the second dress guidon the company commander commands **"Ready, FRONT."** The company continues to march down the line of march and from the field.

d. Platoons execute **"Eyes, RIGHT"** on the command of their platoon commander. After the rear of the platoon has cleared the reviewing area the platoon commander then commands **"Ready, FRONT."**

Enclosure (1)

e. The color guard executes eyes right and ready front on command of the senior color bearer per paragraph 7109. The organizational colors salutes during eyes right if the reviewing officer rates such a salute.

7. If armed with swords, only the company commanders and platoon commanders execute a sword salute at eyes right. All other officers and enlisted personnel armed with swords, in the company/platoon formation, continue to march at carry sword.

→ 8. As the last company begins executing eyes right the band plays any special music requests, if required, immediately followed by the "Marines' Hymn." As the "Marines' Hymn" is being played the drum major faces the reviewing officer and salutes. The reviewing officer returns the salute. The band then picks up march music, marches forward, executes a left turn and marches from the field.

9. After the rear element of the command (normally the band) has passed the staff's position and exited the field, the commander of troops faces the reviewing officer, salutes and reports "Sir/Ma'am, The parade is concluded." After the salute is returned the commander of troops may:

- a. Draws sword with the staff and follow the battalion from the field.
- b. Dismiss the staff.

**NARRATOR: "LADIES AND GENTLEMEN, THIS CONCLUDES TODAY'S CEREMONY. ON BEHALF OF THE COMMANDING OFFICER (GENERAL), OFFICERS AND MARINES OF \_\_\_\_\_, THANK YOU FOR YOUR ATTENDANCE."**

10. After marching off of the parade ground following the march in review, the color guard and color company return the colors as prescribed in chapter 7. Companies march to their respective areas and are dismissed.

17008. SEQUENCE OF EVENTS TO MARCH IN REVIEW IN COLUMN FROM A BATTALION LINE, COMPANY MASS FORMATION

1. After completing the presentation of awards, retirements, etc., and the battalion is at attention, the commander of troops faces the reviewing officer.

→ 2. Reviewing officer commands "**MARCH THE COMMAND IN REVIEW.**" After exchanging salutes, the commander of troops commands "**Staff, Carry, SWORD,**" and then faces the line of troops.

3. Commander of troops commands "**PASS IN REVIEW,**" all personnel armed with swords will execute carry sword.

a. While the battalion is being prepared to march in review the band moves to its position on the line of march.

b. Company commanders, on the command to pass in review, go to carry sword and face their companies. The company commander of the right company in line begins the pass in review.

4. Company Commander commands "**Right Shoulder, ARMS.**"

- a. The company goes to right shoulder arms.

Enclosure (1)

b. When the company is at right shoulder arms the lead company commander glances in the direction of the band to ensure it is ready to march in review. The drum major signifies the band is ready by having halted the band and raising the mace in a high carry position. The company commander of the right company then commands;

5. Company Commander commands **"Column of Threes (Fours), Right Platoon, Column Right, MARCH."**

a. On the command of execution **"MARCH,"** by the company commander of the right company;

(1) The platoon on the right flank of the company executes a column right from the halt.

→ (2) The band steps off and plays *"Semper Fidelis"*. The formation quickly adjusts its step so that the left foot strikes the deck in time with the heavy beat of the drum.

(3) The company commander and company guide step off and march parallel to the line of troops. They execute a column left at the second change of direction to position themselves in front of the lead platoon of the company at the proper interval.

(4) The commander of troops steps to the left in marching and picks up the half step. The staff executes a right turn from the halt, covers on the commander of troops and picks up the half step. When the staff has completed the turn the commander of troops commands **"Staff, Forward, MARCH."** The commander of troops and staff marches down the line and execute two left turns in order to be positioned at the head of the column in front of the band. (See figure 17-7.)

b. The second and subsequent platoon commanders, seeing their platoons about to be uncovered by the platoon on the right command **"Column Right, MARCH"** so that the platoon is in step with and at the proper interval from the platoon to its front in the column. (See figure 17-8.)

c. Subsequent company commanders give the commands of **"Right Shoulder, ARMS"** and **"Column of Threes (Fours), Right Platoon, Column Right, MARCH"** in order to march their companies in review in step with and at the proper interval from the company to its front in the column.

d. The color guard executes carry colors when the company commander of the color company commands **"Right Shoulder, ARMS."** The color guard then makes those movements necessary to march in review at the proper interval from the color company.

e. The platoon commanders as they approach the first turning point give their platoons **"Column Left, MARCH."** (See figure 17-7.)

f. The color guard executes left turns at the turning points.

Enclosure (1)

g. All column movements are made "inside" the line formed by the dress guidons. The platoon guides use the dress guidons as markers to set the direction of march for the platoon.

h. The company commanders as they approach the second turning point give the command of "**Column Left, MARCH**" for themselves and the company guides. Platoon commanders give their platoons "**Column Left, MARCH**" in order to maintain their positions in the company column. (See figure 17-7.)

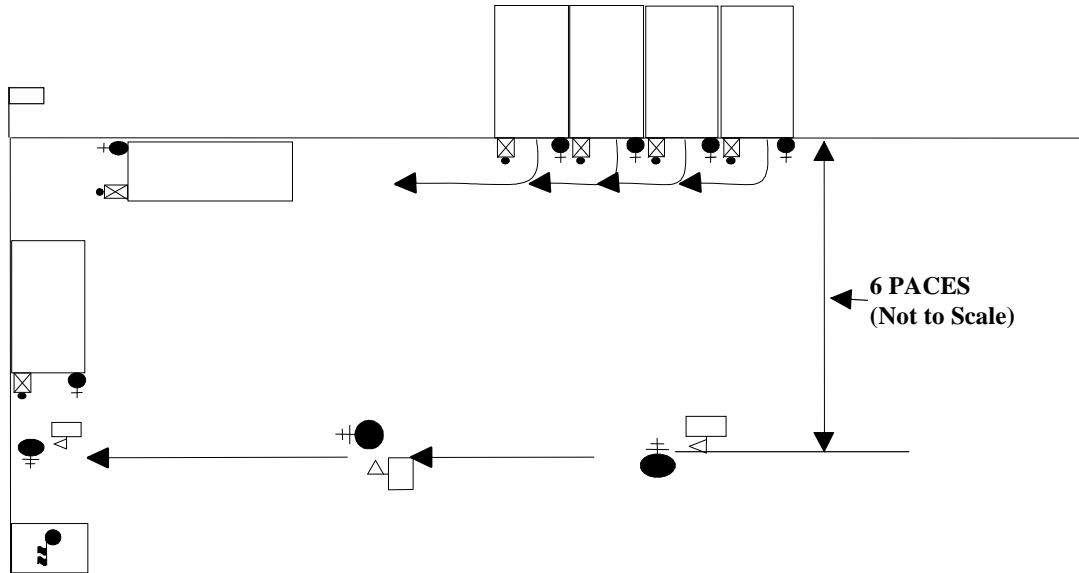

Figure 17-8.--Column of Threes, From the Right.

6. Refer to paragraph 17007.6 for the remainder of the sequence of events for the pass in review.

17009. SEQUENCE OF EVENTS TO MARCH IN REVIEW IN BATTALION COLUMN, COMPANIES IN MASS

1. After completing the presentation of awards, retirements, etc., and the battalion is at attention, the commander of troops faces the reviewing officer.
- 2. Reviewing Officer commands "**MARCH THE COMMAND IN REVIEW.**" After exchanging salutes, the commander of troops commands "**Staff, Carry, SWORD,**" and then faces the line of troops.
3. Commander of troops commands "**PASS IN REVIEW**" and "**Right Shoulder, ARMS.**" The battalion executes right shoulder arms. While the battalion is being prepared to march in review band moves to its position on the line of march.
  - a. On the command of "**PASS IN REVIEW**" all personnel armed with swords will execute carry sword.
  - b. The color guard, on the command of execution "**ARMS,**" goes to carry colors, executes a right turn, halts and remains at the carry.

Enclosure (1)

c. The commander of troops then glances in the direction of the band to ensure it is ready to march in review. The drum major signifies the band is ready by having halted the band and raising the mace in a high carry position. When the band and the battalion is prepared to march in review;

4. Commander of troops commands "**Column of Companies, Right Company, Right Turn-MARCH.**" The right company executes a right turn from the halt and picks up the half step. After the company has completed making the turn the company commander commands "**Forward, MARCH.**"

→ a. The band steps off and plays "*Semper Fidelis*". The formation quickly adjusts its step so that the left foot strikes the deck in time with the heavy beat of the drum.

b. The commander of troops and staff step off on the command of execution "**MARCH.**" The commander of troops steps to the left in marching and picks up the half step. The staff executes a right turn from the halt, covers on the commander of troops and picks up the half step. When the staff has completed the turn the commander of troops commands "**Staff, Forward, MARCH.**"

c. The commander of troops and staff marches down the line and execute two left turns in order to be positioned at the head of the column in front of the band. (See figure 17-7.)

d. The company commanders, as they approach each turning point give the command of "**Left Turn, MARCH**" and "**Forward, MARCH**" to march the company in review. All turning movements are made "inside" the line formed by the dress guidon. The guide of the right platoon of the companies use the dress guidons as markers to set the direction of march for the platoon. (See figure 17-9.)

e. The color guard executes left turns at the turning points.

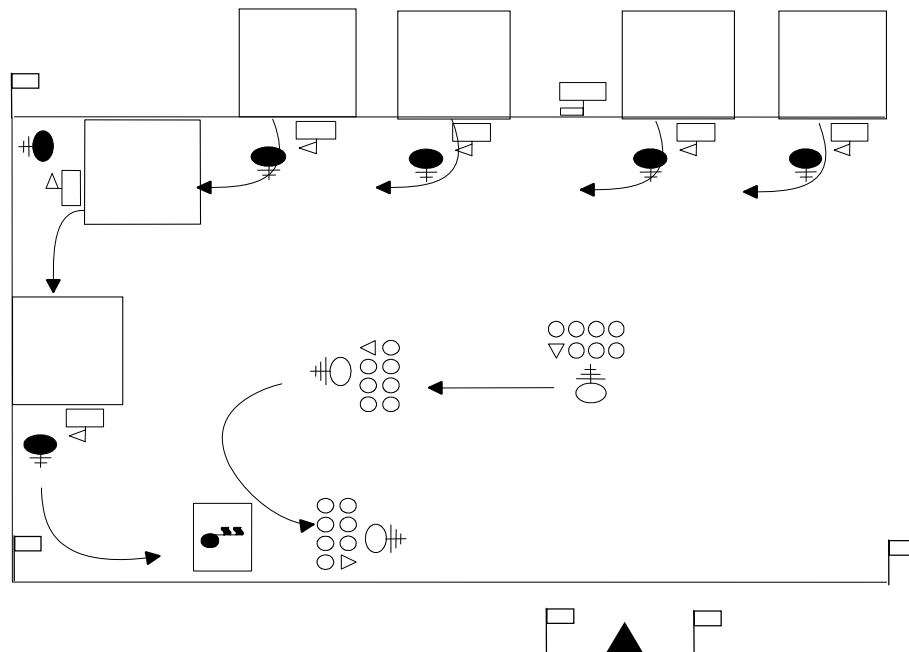

Figure 17-9.--March in Review, Companies in Mass.

Enclosure (1)

5. As the commander of troops, band, company commanders and the color guard approach the reviewing area the command of eyes right will be given;

a. As commander of troops and the staff approach the reviewing area the commander commands **"Staff, Eyes, RIGHT,"** as the reviewing area is cleared, **"Staff, Ready, FRONT."**

(1) The commander of troops and the staff continue to march down the line of troops to the end of the reviewing area, or other designated point, where three right turns are executed in order to place the staff in position to observe the march in review. (See figure 14-8.)

(2) The commander of troops, after the staff is halted, commands the staff to **"Staff, Return, SWORD,"** if so armed. The commander of troops gives the commands of **"Hand, SALUTE,"** and **"Ready, TWO,"** as the color guard passes the staff's position.

b. As the band passes the reviewing area the drum major executes an eyes right and salutes for the band. After clearing the reviewing area, the band is marched to a position approximately 30 paces from the reviewing area, centered on and facing the reviewing officer. The band continues to play march music during the march in review.

c. As each company commander approaches the reviewing area the Marine gives the command of **"Eyes, RIGHT."** The company executes eyes right on the command of the company commander. After the rear of the company has cleared the reviewing area the company commander commands **"Ready, FRONT."** The company continues to march down the line of march and from the field.

d. The color guard executes eyes right and ready front on command of the senior color bearer. The organizational colors salutes during eyes right if the reviewing officer rates such a salute.

e. If armed with swords, only the company commanders and the officers in the front rank of the company execute a sword salute at eyes right. All other officers and noncommissioned officers armed with swords, in the company/platoon formation, continue to march at carry sword.

→ 6. As the last company begins executing eyes right the band plays any special music requests, if required, immediately followed by the *"Marines' Hymn."* As the *"Marines' Hymn"* is being played the drum major faces the reviewing officer and salutes. The reviewing officer returns the salute. The band then picks up march music, marches forward, executes a left turn and marches from the field.

7. After the rear element of the command (normally the band) has passed the staff's position and exited the field, the commander of troops faces the reviewing officer, salutes and reports "Sir/Ma'am, The parade is concluded." After the salute is returned the commander of troops may:

a. Draw sword with the staff and follow the battalion from the field.

b. Dismiss the staff.

**NARRATOR: "LADIES AND GENTLEMEN, THIS CONCLUDES TODAY'S CEREMONY. ON BEHALF OF THE COMMANDING OFFICER (GENERAL), OFFICERS AND MARINES OF \_\_\_\_\_ THANK YOU FOR YOUR ATTENDANCE."**

Enclosure (1)



8. After marching off of the parade ground following the march in review, the color guard and color company returns the colors as prescribed in chapter 7. Companies march to their respective areas and are dismissed.

17010. TO MARCH IN REVIEW, COMPANIES IN A COLUMN OF PLATOONS IN LINE

1. The sequence of events to march in review in company column, platoons in line (see figure 17-10) is the same as specified in paragraphs 17008 and 17009 up through the first column left.
2. After making the initial column left, platoon commanders step to the left of the column and position themselves 6 paces front and centered on their platoons.
3. The company commander and company guide execute a left flank approximately 10 paces short of the second turn marker so as to be centered in front of the platoon in line.
4. The platoon commanders give their platoons the command of **"By the Left Flank, MARCH"** so that the platoon guide is marching down the line of march. The guide, after executing the flanking movement moves up to a position beside the first squad leader.
5. When passing the reviewing area the company commander gives the commands **"Eyes, RIGHT"** and **"Ready, FRONT"** for himself/herself and the company guide only.
6. Platoon commanders will give the commands **"Eyes, RIGHT"** and **"Ready, FRONT"** to their platoons.
7. After passing in review, and when reaching the designated spot (far enough away from the reviewing area so as not to interfere with following companies passing in review) the company returns to column formation, by executing a right flank and then executing a column left to depart the field.

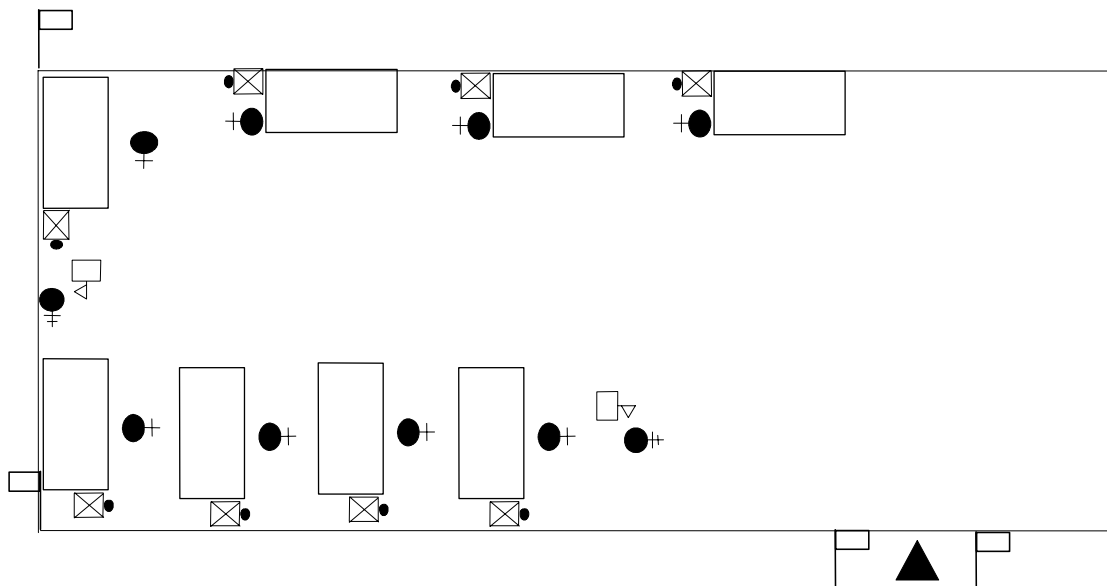

Figure 17-10.--Marching in Review, Companies in Column of Platoons on Line.

17011. REGIMENTAL PARADES. The regiment normally forms in line of battalions with companies in line or in mass formation to conduct ceremonial parades. The parade proceeds as for the battalion with the following exceptions:

1. Regiment is substituted for battalion in description.
2. Battalions and independent companies form the regiment as prescribed in chapter 10 and 11.
3. Battalions and independent companies execute movements on the command of their respective commanders. The battalion and independent company commanders make reports to the regimental adjutant.
4. When trooping the line, after "*Sound Off*," the band passes midway between the line of battalion commanders and the regimental adjutant.
5. During officers center, battalion commanders and staffs close to the center on the original line of battalion commanders. (See figure 17-11.) The battalion commanders remain centered on their staffs. Company commanders oblique forward to close on a line 4 paces behind the line of battalion commanders (and staffs if directed). Guidon bearers oblique forward to close on a line 4 paces behind the line of company commanders. Platoon commanders oblique forward to close on a line 4 paces behind the line of guidon bearers. After officers center, while posting, the staff moves as a unit with their battalion commander.
6. During the march in review, if the parade is being conducted with companies in line formation and after the band has repositioned, the commander of the right battalion or independent company commands "**Right, FACE**" and "**Right Shoulder, ARMS,**" and column of threes is formed. Remaining battalions and independent companies form column of threes and come to right shoulder arms on commands from their respective commanders in succession from right to left. When all units are at right shoulder arms, the commander of the right unit commands "**Forward, MARCH.**" The band steps off playing on this command. Commanders of succeeding units give similar commands to set their units in motion so as to follow at the prescribed distances.
7. During the march in review, if the companies are in mass formation and after the band has repositioned, the commander of the right battalion commands "**Right Shoulder, ARMS;**" and "**Column of Companies, Right Company, Right Turn, MARCH.**" Should an independent company be on the right, its commander commands "**Right Shoulder, ARMS;**" and "**Right Turn, MARCH.**" The band steps off playing with the right unit. Commanders of succeeding units give similar commands to set their units in motion so as to follow at the prescribed distances.
8. During the march in review, battalion commanders and their staffs initially march parallel to the line of troops and take position at the head of their battalions after the first change of direction. The commander of troops and the staff take position at the head of the band after the second change of direction. (See figure 17-12.)

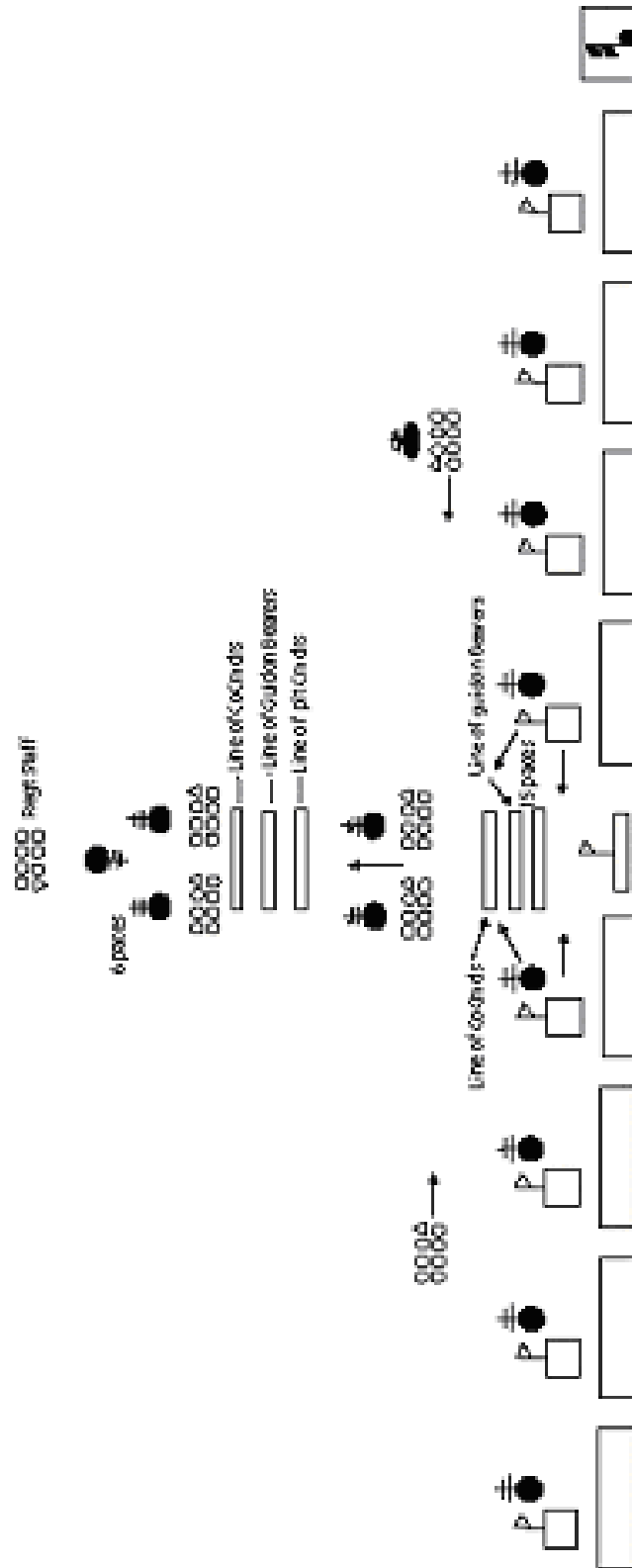

Figure 17-11.--Regimental Officers Center.

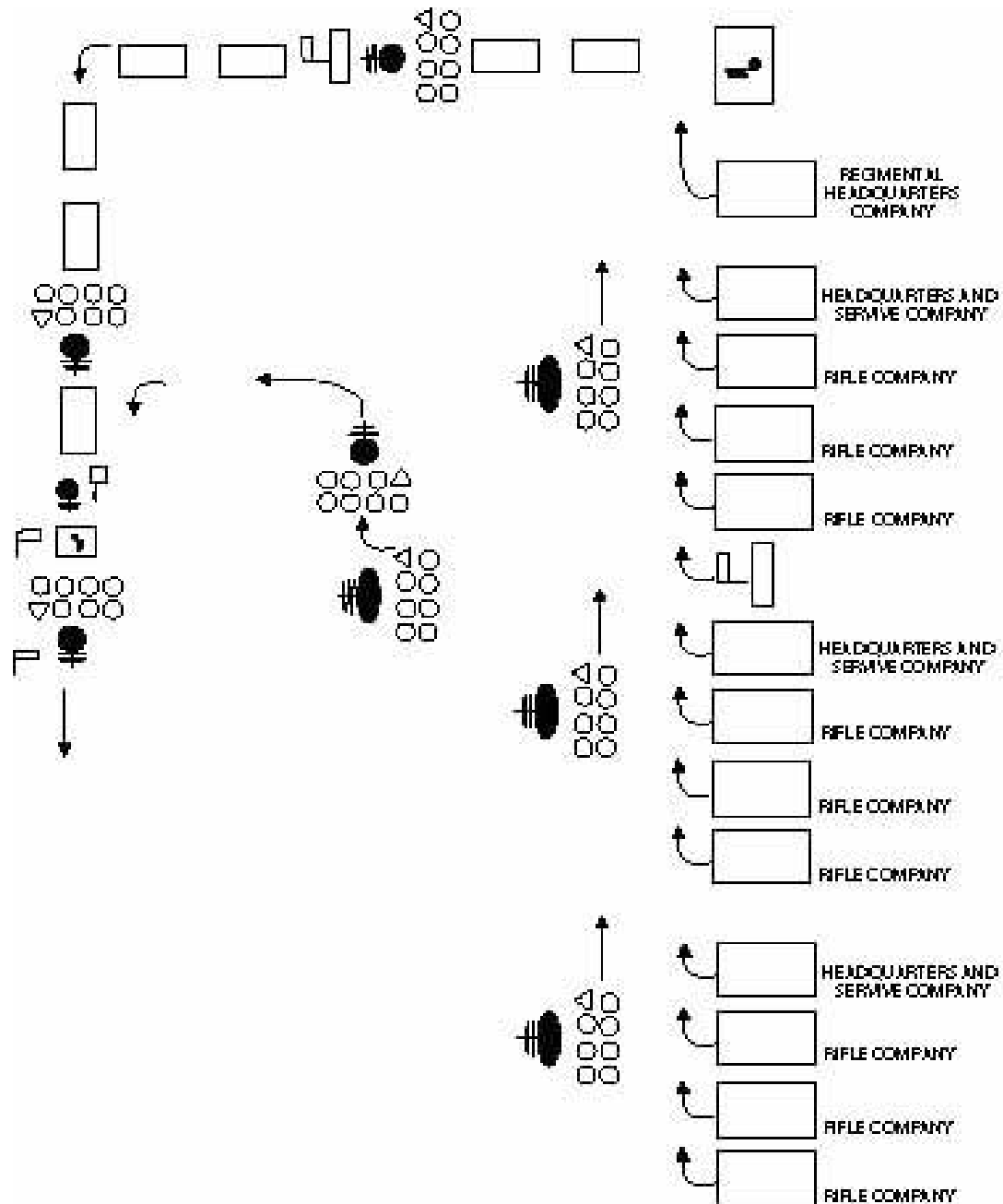

Figure 17-12.--Regimental March in Review.

9. Battalion commanders and their staffs execute eyes right in the same manner as the commander of troops and the staff. Companies march in review in mass formation, column of threes, or column of platoons in line executing changes in direction, flanking movements, and eyes right as appropriate in the same manner as in a battalion parade. After passing in review, only the regimental staff halts near the reviewing area and returns swords. The battalion commanders and their staffs continue to march down the line of march and lead their battalions from the parade field.

17012. BATTALION AND REGIMENTAL FORMATIONS

1. For occasions in which ceremony is desired, but the situation does not provide the opportunity or necessary space for maneuvering units as in a review or a parade, a battalion or regimental ceremonial formation may be conducted. One of several variations may be used according to the situation and type of ceremony desired.

2. One type of battalion (regimental) ceremonial formation is similar to that of a review except that the march in review is omitted. The battalion (regimental) commander acts as the reviewing officer and the executive officer (or other officer so appointed) acts as the commander of troops. Basically, the battalion or regiment forms in line with companies in line or companies in mass formation at "*Adjutant's Call*" for the formation in the same manner as for a review.

- a. For a morning formation including Morning Colors, after the battalion (regiment) is presented to the commander of troops, the commander of troops commands "**SOUND ATTENTION.**" The band sounds "*Attention*". The Commander of troops then commands "**PRESENT ARMS.**" All persons in formation render appropriate salutes. The band then plays the "*National Anthem*" to which the colors are raised while the "*National Anthem*" is played. Immediately following the "*National Anthem*" the band plays "*Carry On.*"
- b. For an evening formation including "*Retreat*", after the battalion (regiment) is presented to the commander of troops, the commander of troops commands "**SOUND ATTENTION.**" The band sounds "*Attention*". The Commander of troops then commands "**PRESENT ARMS.**" All persons in formation render appropriate salutes. The band then plays the "*Retreat*" followed immediately by the "*National Anthem*" to which the colors are lowered while the "*National Anthem*" is played. Immediately following the "*National Anthem*" the band plays "*Carry On.*"
- c. After the command is presented to the commander of troops, if morning/evening colors is not conducted, the commander of troops presents the command to the reviewing officer. If morning/evening colors are part of the ceremony, the commander of troops presents the command to the reviewing officer following the conduct of morning/evening colors.
- d. Presentation of decorations, promotions, retirements, etc., may then be conducted. The commander of troops then dismisses the battalion (regiment). The color guard and color company (battalion) return the colors.

3. Another type of formation is conducted in the same manner as a ceremonial parade, except that the march in review is omitted. The following additional modifications may be made:

- a. The band may "*Sound Off*" in place instead of marching. If evening colors is part of the formation, "*Retreat*" is sounded after the band's second "*Sound Off*," and the adjutant brings the command to attention and to present arms. The flag is lowered while the "*National Anthem*" is played. For a formation at morning colors, the procedure is similar, except after the second "*Sound Off*," the band sounds "*First Call*," then the adjutant brings the command to attention and present arms for the flag to be raised while the "*National Anthem*" is played. After colors, the adjutant may bring the troops to order arms and then dismiss the command, or while troops are still at present arms following colors, the adjutant presents the command to the commander of troops.
- b. The commander of troops presents the command to the battalion (regimental) commander. Then decorations, promotions, retirements, etc., may be presented.

Enclosure (1)

- c. On completion of the ceremony, the command is dismissed. The color guard and color company return the colors.
4. In any of the above ceremonial formations, the battalion (regimental) commander may act as both the commander of troops and the reviewing officer. In this case the following modifications are made:
    - a. The adjutant presents the command to the battalion (regimental) commander after the troops are formed. The presentation normally made to the reviewing officer is omitted.
    - b. During the presentation of decorations, promotions, retirements, etc., the adjutant performs those duties normally required of the commander of troops.

17013. STREET PARADES

1. A person designated as the Grand Marshal commands street parades. The grand marshal appoints a chief of staff and aides, and issues an order concerning the formation, movement and dismissal of the parade. This order includes:
  - a. The names of the staff officers and when and where they are to report to the marshal.
  - b. The assignment of organizations and their order in battalions and larger units, and the names and assignment of battalion commanders and marshals of larger units.
  - c. The streets upon which the battalions and larger units are to form, the direction their lines or columns face, where the right of line or head of column rests, and the width of the fronts of the subdivisions in column.
  - d. The times for each unit to complete it's forming and be ready to march.
  - e. The time and place at, and from, which the head of the parade will move, the line of march and the direction of guide.
  - f. Honors to be paid during the march.
  - g. Instructions for dismissal of the parade.
  - h. Instructions regarding uniform and equipment.
2. The grand marshal may review the parade at some point beyond the reviewing stand before its dismissal.
3. The order of precedence of units in street parades involving two or more services of the United States or of a foreign nation are the same as prescribed in paragraph 15001. Veterans and patriotic organizations parade in the order prescribed by the grand marshal.
4. The grand marshal marches at the head of the parade. The staff, chief of staff on the right, marches 1 1/2 paces to the rear in one or more ranks. Mounted police and a platoon of dismounted police who clear the way usually precede the grand marshal. The marshal of the first unit marches 24 paces to the rear of the staff of the grand marshal.

Enclosure (1)

a. Odd-numbered units are usually formed in streets to the right of the line of march, the first unit nearest the starting point. Even-numbered units are similarly formed on streets to the left of the line of march. Among formations which may be used for street parades are columns of threes (fours) abreast and mass formation. Transportation marches in single column or columns of twos, threes, or fours depending on the width of the street.

b. In long parades, rifles may be carried at sling arms with fixed bayonets.

MARINE CORPS DRILL AND CEREMONIES MANUAL

PART II: CEREMONIES

CHAPTER 18

PRESENTATION OF DECORATIONS AND INDIVIDUAL RETIREMENT

	<u>PARAGRAPH</u>	<u>PAGE</u>
GENERAL . . . . .	18000	18-3
FORMATION . . . . .	18001	18-3
SEQUENCE OF EVENTS FOR THE PRESENTATION OF AWARDS . . . . .	18002	18-4
SEQUENCE OF EVENTS FOR RETIREMENTS . . . . .	18003	18-8
SEQUENCE OF EVENTS FOR DECORATING UNIT COLORS . . . . .	18004	18-11
COMBINED CEREMONIES . . . . .	18005	18-13
BATTLE COLORS CEREMONY . . . . .	18006	18-15

FIGURE

18-1	POSITIONS OF RETIREES AND AWARD RECIPIENTS. . . . .	18-4
18-2	PRECEDENCE OF AWARD RECIPIENTS. . . . .	18-5
18-3	COMMANDER OF TROOPS MOVES TO GET COLORS AND AWARD RECIPIENTS. . . . .	18-5
18-4	COLORS AND AWARD RECIPIENTS BROUGHT FORWARD . . . . .	18-6
18-5	POSTING THE COLORS AND AWARD RECIPIENTS . . . . .	18-8
18-6	RETIREES TAKE THEIR POSTS . . . . .	18-9
18-7	PRECEDENCE FOR COMBINED AWARDS AND RETIREMENT CEREMONIES. . . . .	18-14





MARINE CORPS DRILL AND CEREMONIES MANUAL

PART II: CEREMONIES

CHAPTER 18

PRESENTATION OF DECORATIONS AND INDIVIDUAL RETIREMENT

18000. GENERAL

1. Ceremonies for the presentation of decorations and individual retirement shall be conducted as prescribed in this Chapter. They will include the following:

- a. The presentation of United States decorations.
- b. The decoration of organizational colors.
- c. The presentation of foreign decorations.
- d. The re-dedication of a unit's battle colors.
- e. The retirement of an individual or a group of any rank.

f. Throughout this Chapter, the term "sergeant major" will be used to reflect the actual billet of the unit sergeant major, or the senior enlisted representative present.

2. When practicable, the ceremony set forth below will be held when presenting individual and unit awards and decorations or upon retirement of individuals. The ceremony may be as simple as a formation of the unit affected, a review or a parade depending on the desires of the commander.

18001. FORMATION

1. The command is formed for the appropriate ceremony (e.g., unit formation, parade or review) per this Manual.

2. The color guard is not trooped, but marches on with the formation since the colors are brought forward for the ceremony.

3. Marines, Sailors and other service members receiving awards and decorations are formed as the last rank of the company to the color guard's left and march on with the unit. (See figure 18-1). They fall in according the rank of the decoration to be conferred, the highest ranking decoration on the right.

4. Marines, Sailors and other service members who are retiring sit in the reviewing stand with their families, since this parade is being held in their honor. (See figure 18-1.) When the time comes to effect their retirement, the retirees form to the left of the reviewing stand in a column, from front to rear as listed below, so that they are arranged by seniority, from right to left, when presented to the reviewing officer. They march on when the colors have halted and prior to the commander of troops reporting "**Person(s) to be Retired All Present.**" (See figure 18-5.)

a. Junior retiree, by grade, not receiving an award to senior retiree, by grade, not receiving an award.

b. Junior retiree, by grade, by award, not by rank for award only.

5. The sequence for the presentation of awards, effecting retirements and battle colors re-dedication begins after the commander of troops has presented the command to the unit commander and the command is back at order arms if a parade, or after trooping the line if a review. The commander of troops, having placed the command at attention and order arms, faces the reviewing area. Seeing that the reviewing officer is in position the commander of troops faces the command and begins the sequence of events to present awards per paragraph 18002, effect retirements per paragraph 18003, to decorate unit colors per paragraph 18004, conduct a combined ceremony per paragraph 18005, or re-dedicate a units battle colors per paragraph 18006.

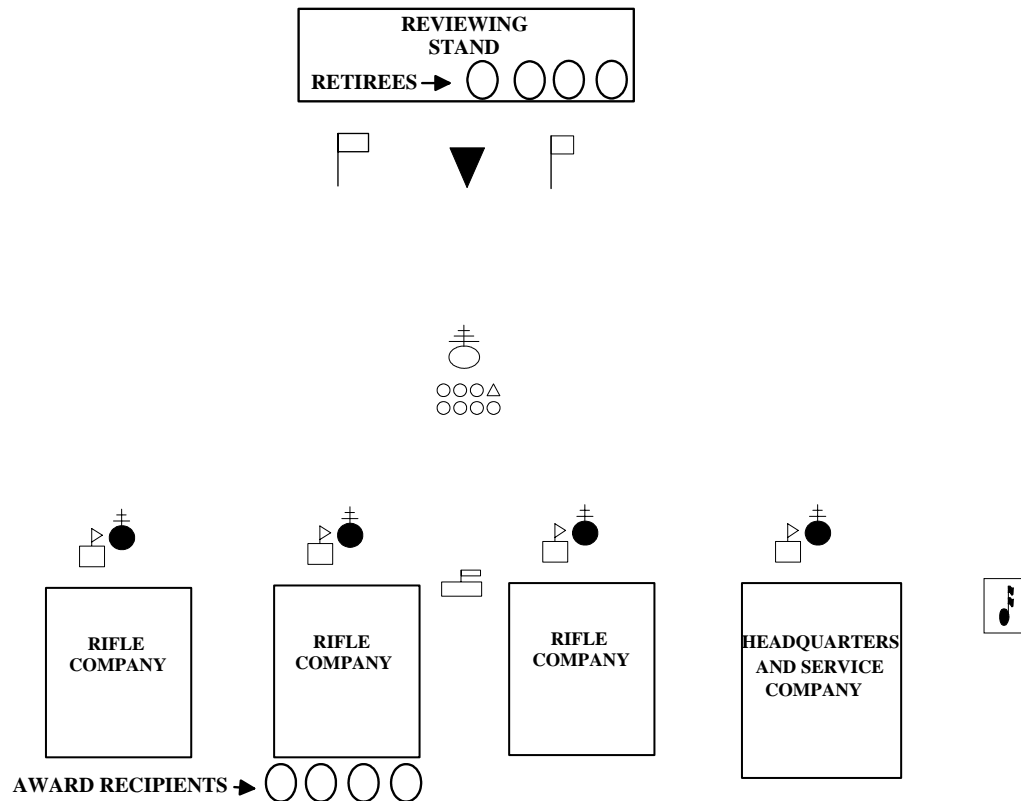

Figure 18-1.--Positions of Retirees and Award Recipients.

18002. SEQUENCE OF EVENTS FOR THE PRESENTATION OF AWARDS

1. Commander of troops commands **"Person(s) to be Decorated and All Colors, Center, MARCH."** On the command **"Colors,"** the color guard goes to carry colors and the staff goes to carry sword.

a. On the command **"Center,"** person(s) to receive awards and the staff execute a right face.

b. On the command **"MARCH,"** the staff steps off and moves forward approximately 8-10 paces, halts, executes a left face and goes to order sword.

c. The award recipients step off and march to a position 5 paces in front of and centered on the colors. (See figure 18-2.)

**REVIEWING STANDS**

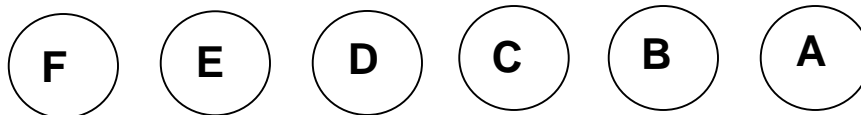

- A. Personal Decoration by order of precedence (senior recipient)
- B. Personal Decoration by order of precedence (junior recipient)
- C. Service Award by order of precedence (senior recipient)
- D. Service Award by order of precedence (junior recipient)
- E. Other Awards by order of precedence (senior recipient)
- F. Other Awards by order of precedence (junior recipient)

Figure 18-2.--Precedence of Award Recipients.

d. The commander of troops, once the staff has cleared, marches forward to the line of award recipients, halts 5 paces in front of them, salutes the colors, and faces about. (See figure 18-3.)

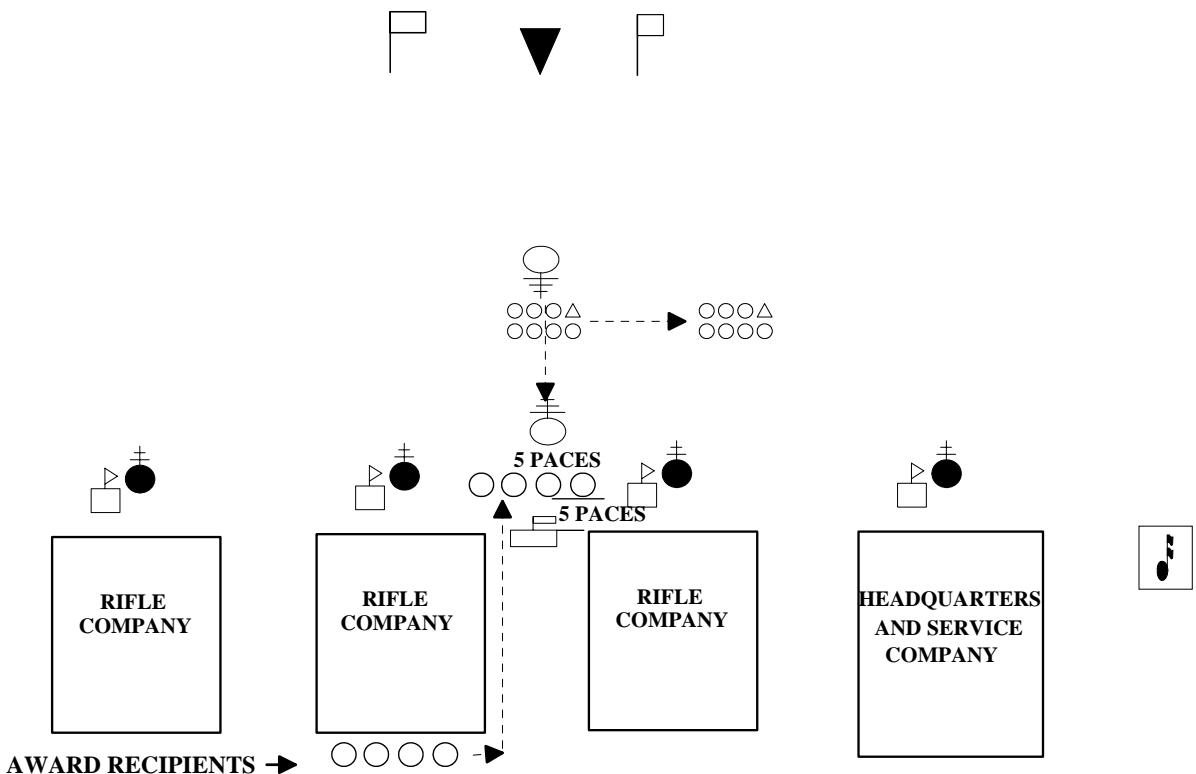

Figure 18-3.--Commander of Troops Moves to Get Colors and Award Recipients.

2. Commander of troops commands **"Forward, MARCH."**

a. The commander of troops, award recipients and color guard march forward towards the reviewing area. The commander of troops commands **"Detachment, HALT"** so that the detail is halted with the commander of troops approximately 10 paces in front of and centered on the reviewing officer. (See figure 18-4.) The color guard remains at the carry.

b. The adjutant commands the staff to carry swords, left face and marches the staff back to its position, where the staff halts, faces the reviewing area and goes to order sword on command of the adjutant. The commander of troops then salutes the reviewing officer and reports, **"Sir/Ma'am, Person(s) to be Decorated and All Colors are Present."** The commander returns the commander of troops' salute.

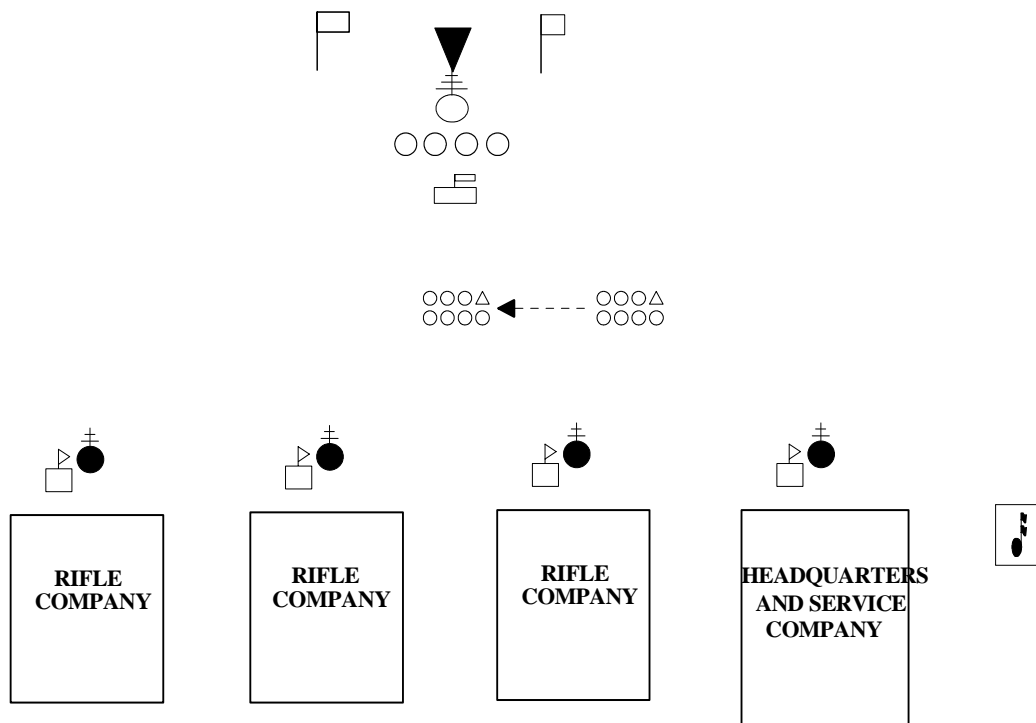

Figure 18-4.--Colors and Award Recipients Brought Forward.

- 3. Reviewing Officer commands **"PRESENT THE COMMAND."** The commander of troops returns to the carry, steps right in marching and moves to a position in front of the staff, saluting the colors as the Marine passes them, halts facing the line of troops.
- 4. Commander of troops commands **"Present, ARMS."** The unit executes. The commander of troops faces the reviewing area.
- 5. Commander of troops then commands **"Staff, Present, ARMS."** The commander of troops and staff execute present sword.

**NARRATOR: "LADIES AND GENTLEMEN PLEASE RISE FOR HONORS TO OUR NATIONAL COLORS."**

Enclosure (1)

a. The color guard riflemen execute present arms, from the carry upon command of the staff.

→ b. On the first note of the "National Anthem" or "To The Color" the award recipients and reviewing officer executes a hand salute and the organizational color bearer presents colors.

→ c. After the last note of the "National Anthem" or "To The Color" the organizational color bearer returns to the carry position. The award recipients and reviewing officer terminates their salute.

6. Commander of troops commands "**Staff, Order, SWORD.**" The commander of troops, staff, and color guard go to the order. The commander of troops then goes to carry sword and faces the line of troops.

**NARRATOR: "LADIES AND GENTLEMEN, PLEASE BE SEATED."**

7. Commander of troops commands "**Order, ARMS.**" The unit executes. The commander of troops then faces the reviewing area and goes to order sword.

8. The reviewing officer, assisted by the sergeant major now moves forward and presents the awards. As the reviewing officer arrives in front of each award recipient the narrator reads the award citation and the reviewing officer attaches the medal over the left breast pocket of the recipient.

a. When the medal is attached the reviewing officer and recipient shake hands. Immediately after shaking hands, the award recipient salutes the reviewing officer, who returns the salute.

b. The reviewing officer then moves to the next award recipient by stepping to the left in marching, taking approximately 1 1/2 steps, halts and faces the next recipient.

→ c. After the last award is presented the reviewing officer moves back to the reviewing area and the sergeant major departs the field.

→ 9. Commander of troops commands "**Staff, Carry, SWORD**" and "**POST THE COLORS.**" The commander of troops and staff execute carry swords. The color guard executes carry colors on command from the color sergeant.

10. Commander of troops commands "**Staff, Right, FACE**" and "**Staff, Forward, MARCH.**" The commander of troops and staff execute.

a. Color guard executes a countermarch and moves back to its position in formation, countermarches, halts and goes to order colors. (See figure 18-5.)

→ b. The commander of troops and staff march forward, per paragraph 14003.4, sufficiently for the colors to pass, halts, and executes a left face. When the colors have passed the commander of troops moves the staff back to its position, halts and executes a right face and goes to order sword on command of commander of troops. However, the commander of troops faces the line of troops, remaining at carry sword. When the color guard is in position, and at order colors, the commander of troops faces the reviewing area. (See figure 18-5.)

Enclosure (1)

c. The award recipients march to their position in the reviewing area, and form a line at normal interval, to the left of the reviewing officer. (See figure 18-5.)

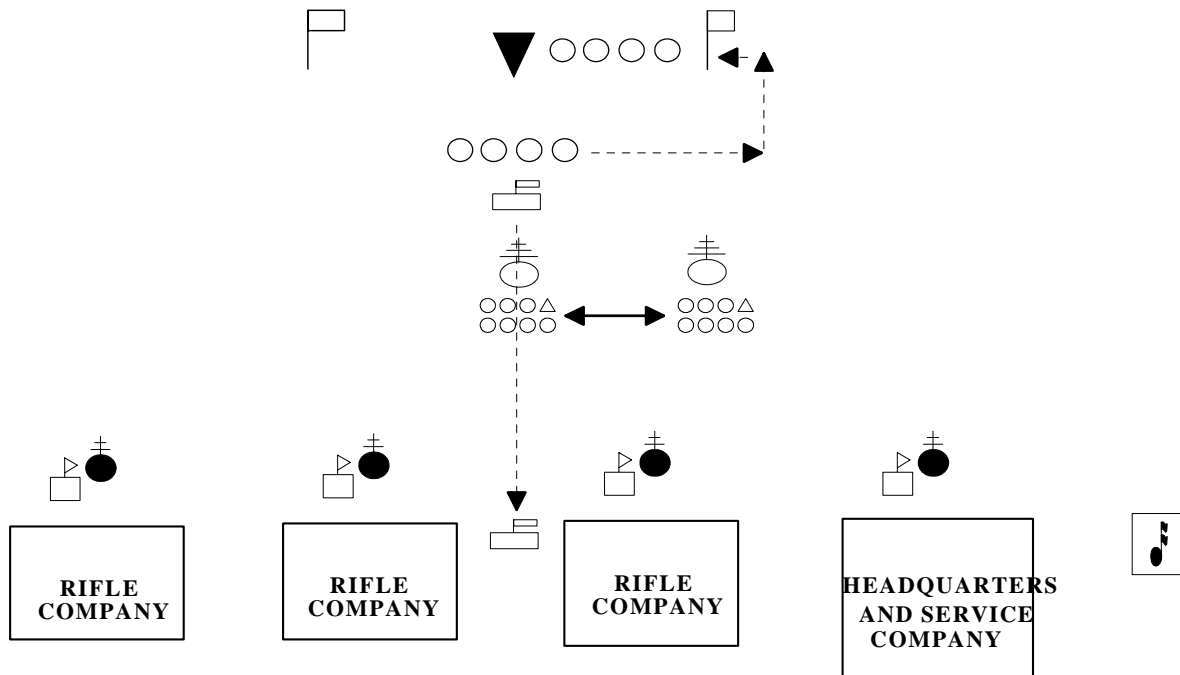

Figure 18-5.--Posting the Colors and Award Recipients.

11. The ceremony would then continue as prescribed for a review (see chapter 16), parade (see chapter 17) or unit formation. (e.g., the command be marched in review, dismissed, etc.)

#### 18003. SEQUENCE OF EVENTS FOR RETIREMENTS

1. After the command has been presented to the reviewing officer, and while the commander of troops is giving the command of **"Order, ARMS,"** the retirees form to the left of the reviewing stand. The retirees form in a single file at twice the normal distance so that they will be extended interval when halted in front of the reviewing officer. This allows space for their spouses to stand at their left. They march on in reverse order. (See figure 18-6.)

2. Commander of troops commands **"Person(s) to be Retired and All Colors, Center, MARCH."** On the command **"Colors,"** the color guard goes to carry colors and the staff goes to carry sword.

a. On the command **"Center,"** the staff executes a right face.

→ b. On the command **"MARCH,"** the staff steps off and moves forward approximately 10 paces, halts, and executes a left face.

c. The commander of troops, once the staff has cleared, marches forward to the color guard, halts 10 paces in front of them, salutes the colors, and faces about.

Enclosure (1)

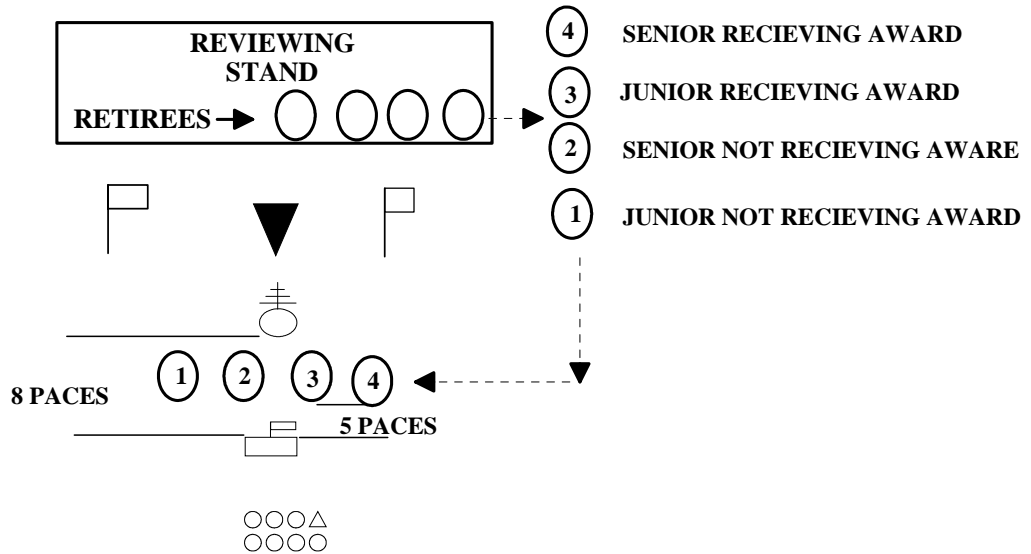

Figure 18-6.--Retirees take Their Posts.

3. Commander of troops commands **"Forward, MARCH."** The commander of troops and color guard march forward towards the reviewing area. The commander of troops commands **"Detachment, HALT"** so that the detail is halted with the commander of troops approximately 10 paces in front of and centered on the reviewing officer. (See figure 18-3.) The color guard remains at the carry.

➔ a. The adjutant commands left face and marches the staff back to its position, where the staff halts, faces the reviewing area and goes to order sword.

b. The retirees march forward, execute a column right, march to a position 5 paces in front of the color guard, halt and execute a right face. They will be at extended interval.

c. The commander of troops, once the retirees are in position, salutes the reviewing officer and reports **"Sir/Ma'am, Person(s) to be Retired and All Colors are Present."** The reviewing officer returns the commander of troops' salute.

➔ 4. Reviewing officer commands **"PRESENT THE COMMAND."** The commander of troops returns to the carry, steps right in marching and moves to a position in front of the staff, saluting the colors as he/she passes them, and halts facing the line of troops.

5. Commander of troops commands **"Present, ARMS."** The unit executes. The commander of troops faces the reviewing area.

➔ 6. Commander of troops then commands **"Staff, Present, ARMS."** The commander of troops and staff execute present sword.

**NARRATOR: "LADIES AND GENTLEMEN PLEASE RISE FOR HONORS TO OUR NATIONAL COLORS."**

a. The color guard riflemen execute present arms on the command of the staff, from the carry.

Enclosure (1)



- b. On the first note of the "*National Anthem*" or "*To The Color*" the retirees and reviewing officer executes a hand salute and the organizational color bearer presents colors.
  - c. After the last note of the "*National Anthem*" or "*To The Color*" the organizational color bearer returns to the carry position. The retirees and reviewing officer terminates their salute.
7. Commander of troops commands "**Staff, Order, SWORD.**" The commander of troops, staff, and color guard go to the order. The commander of troops then goes to carry sword and faces the line of troops.
8. Commander of troops commands "**Order, ARMS.**" The unit executes. The commander of troops then faces the reviewing area and goes to order sword.

**NARRATOR: "LADIES AND GENTLEMEN, PLEASE BE SEATED."**

9. The reviewing officer, assisted by the sergeant major now moves forward and presents the awards, if any, and effects the retirements.
- a. As the reviewing officer arrives in front of each retiree the narrator reads the award citation, if any, and the reviewing officer attaches the medal over the left breast pocket of the recipient.
  - b. The narrator then reads extracts from the retirement orders, (e.g., Transferred to the retired list (FMCR) after 20 years of service, Date of retirement, etc.). At this time each retiree is presented a national flag.
  - c. The reviewing officer then moves to the next retiree by stepping to the left in marching, taking approximately 1 1/2 steps, halts and faces the next recipient. After the last retirement has been effected, the reviewing officer moves back to the reviewing area and the sergeant major departs the field. (If spouses are to be recognized the sergeant major will remain and assist the reviewing officer). If spouses are not recognized the reviewing officer followed by the retirees may make remarks.
10. Once the last retirement order is read and if there will be recognition of the spouses and remarks by the reviewing officer and retirees, the commander of troops will come to the carry, face about and order parade rest. The commander of troops will then face about and give the staff parade rest.
11. Marines assigned to do so, now escort the spouses of the retirees to the left of their husband/wife, and stand behind the spouse they escorted.
- a. The narrator then reads the spouses citation (Optional).
  - b. After all spouses have been recognized the Marines assigned as escorts will return the spouses to their seats.
  - c. At this time the reviewing officer moves back to the reviewing area and the sergeant major departs the field. The reviewing officer followed by the retirees may make remarks at this time.
  - d. Once all remarks have been made the reviewing officer returns to the designated position in the reviewing area.

Enclosure (1)

e. The commander of troops, seeing the reviewing officer back in position, comes to attention, and goes to carry sword.

12. Commander of troops commands "**Staff, ATTENTION,**" faces about and commands "**(Size of Unit), ATTENTION.**" Commander of troops faces about and commands "**POST THE COLORS**" and "**Staff, Carry, SWORD.**" The commander of troops and staff execute carry swords. The color guard executes carry colors.

13. Commander of troops commands "**Staff, Right, FACE**" and "**Staff, Forward, MARCH.**" The commander of troops and staff execute.

a. Color guard executes a countermarch and moves back to its position in formation, countermarches, halts and goes to order color. (See figure 18-5.)

b. The commander of troops and staff march forward sufficiently as prescribed in paragraph 14003.4c through 14003.4f for the colors to pass, halts, does a left face and goes to order sword. When the colors have passed the commander of troops moves the staff back to its position, halts and executes a right face and goes to order sword. However, the commander of troops faces the line of troops, remaining at carry sword. When the color guard is in position, and at order colors, the commander of troops faces the reviewing area. (See figure 18-5.)

c. The retirees on command of the commander of troops march to their position in the reviewing area, and form a line at normal interval, to the left of the reviewing officer. (See figure 18-5.)

20. The ceremony would then continue as prescribed for a review (see chapter 16), a parade (see chapter 17) or unit formation. (e.g., the command be marched in review, dismissed, etc.)

#### 18004. SEQUENCE OF EVENTS FOR DECORATING UNIT COLORS

1. Commander of troops commands "**All Colors, Center, MARCH.**" On the command "**Colors,**" the color guard goes to carry colors and the staff goes to carry sword.

a. On the command "**Center,**" the staff executes a right face.

b. On the command "**MARCH,**" the staff steps off and moves forward approximately 8-10 paces, as prescribed in paragraph 14003.4c through 14003.4f, halts, executes a left face and goes to order sword.

c. The colors being decorated step off and march to a position 5 paces in front of and centered on the color guard. (Note: This portion of the movement is only if the units receiving unit awards are subordinate to the parade unit (e.g., battalion colors being decorated at a regimental parade.) If the unit hosting the parade is also the unit receiving the award, then the unit colors remains in the color guard.

d. The commander of troops, once the staff has cleared, marches forward to the line of organizational colors, halts 5 paces in front of them, salutes the colors, and faces about.

2. Commander of troops commands "**Forward, MARCH.**"

a. The commander of troops, award recipients and color guard march forward towards the reviewing area. The commander of troops commands **"Detachment, HALT"** so that the detail is halted with the commander of troops approximately 10 paces in front of and centered on the reviewing officer. (See figure 18-4.) The color guard remains at the carry.

b. The adjutant commands the staff to carry swords, left face and marches the staff back to its position, where the staff halts, faces the reviewing area and goes to order sword. The commander of troops then salutes the reviewing officer and reports, **"Sir/Ma'am, All Colors are Present."** The reviewing officer returns the commander of troops' salute.

3. Reviewing officer commands, **"PRESENT THE COMMAND."** The commander of troops returns to the carry, steps right in marching and moves to a position in front of the staff, saluting the colors as he/she passes them, and halts facing the line of troops.

**NARRATOR: "LADIES AND GENTLEMEN PLEASE RISE FOR HONORS TO OUR NATIONAL COLORS."**

4. Commander of troops commands **"Present, ARMS."** The unit executes. The commander of troops faces the reviewing area.

5. Commander of troops then commands **"Staff, Present, ARMS."** The commander of troops and staff execute present swords.

a. The color guard riflemen execute present arms on the command of the staff, from the carry.

→ b. On the first note of the "National Anthem" or "To The Color" the reviewing officer executes a hand salute and the organizational color bearer, and colors being decorated, present colors.

→ c. After the last note of the "National Anthem" or "To The Color" the organizational color bearer returns to the carry position. The award recipients and reviewing officer terminates their salute.

6. Commander of troops commands **"Staff, Order, SWORD."** The commander of troops and staff, go to the order. The color guard returns to the carry. The commander of troops then goes to carry sword and faces the line of troops and commands.

7. Commander of troops commands **"Order, ARMS."** The unit executes. The commander of troops then faces the reviewing area and goes to order sword.

**NARRATOR: "LADIES AND GENTLEMEN, PLEASE BE SEATED."**

8. The reviewing officer, unit commander(s) and sergeant major now move forward to present the awards. As the reviewing officer arrives in front of the colors being decorated the narrator reads the award citation.

a. The organizational color bearer dips the colors forward sufficiently, without the colors touching the ground, to allow the reviewing officer to reach the streamer attachment set. The reviewing officer then attaches the streamer to the colors.

Enclosure (1)

b. The reviewing officer then moves to the next colors by stepping to the left in marching, taking approximately 1 1/2 steps, halts and faces the colors.

c. After the streamer is attached the reviewing officer and unit commander moves back to the reviewing area and the sergeant major departs the field.

d. Remarks if desired are made. If remarks are to be made the commander of troops will place the unit and staff at parade rest. After remarks are completed and the reviewing officer is back in the designated position, the commander of troops will bring the staff and the unit back to attention.

e. If no remarks are made, the commander of troops, seeing the reviewing officer back in position, goes to carry sword.

9. Commander of troops commands "**POST THE COLORS**" and "**Staff, Carry, SWORD.**" The commander of troops and staff execute carry swords.

10. Commander of troops commands "**Staff, Right, FACE**" and "**Staff, Forward, MARCH.**" The commander of troops and staff execute.

a. Color guard executes a countermarch and moves back to its position in formation, countermarches, halts and goes to order colors. (See figure 18-5.)

b. The commander of troops and staff march forward, all on command from the commander of troops, sufficiently for the colors to pass, halts, does a left face and goes to order sword. When the colors have passed the commander of troops moves the staff back to its position, halts and executes a right face and goes to order sword. However, the commander of troops faces the line of troops, remaining at carry sword. When the color guard is in position, and at order colors, the commander of troops faces the reviewing area. (See figure 18-5.)

11. The ceremony would then continue as prescribed for a review (see chapter 16), a parade (see chapter 17) or unit formation. (e.g., the command be marched in review, dismissed, etc.)

#### 18005. COMBINED CEREMONIES

1. On occasion, it will be necessary to combine retirements, awarding personal decorations and unit awards in one ceremony. The ceremony would follow the sequence in paragraph 18002, with the following exceptions.

a. Award recipients and retirees either form behind the company to the left of the color guard, or in the reviewing stand. (See figure 18-1.) If personnel are marching from both locations the unit leader will coordinate in advance how they will march on and position themselves in front of the reviewing officer.

b. In order to bring forward the award recipients and retirees the commander of troops commands "**Person(s) to be Decorated, Retired and All Colors, Center, MARCH.**" When reporting to the reviewing officer the commander reports, "**Sir/Ma'am, Person(s) to be Decorated, Retired and All Colors are Present.**"

c. Spouses of retirees are not brought forward.

d. The formation for the colors receiving awards, person(s) being decorated and retired is depicted in figure 18-7. In those circumstances where an individual is both receiving a decoration and retiring, the Marine would be placed in the line by the precedence of the decoration. In this case the decoration is presented and the retirement is effected prior to moving to the next individual in rank. Use the following precedence for individuals as an example.

- (1) Unit decoration in order of precedence.
- (2) Individual receiving a decoration in order of precedence and retiring.
- (3) Individual receiving a decoration in order of precedence.
- (4) Senior individual retiring with no decoration.
- (5) Junior individual retiring with no decoration.

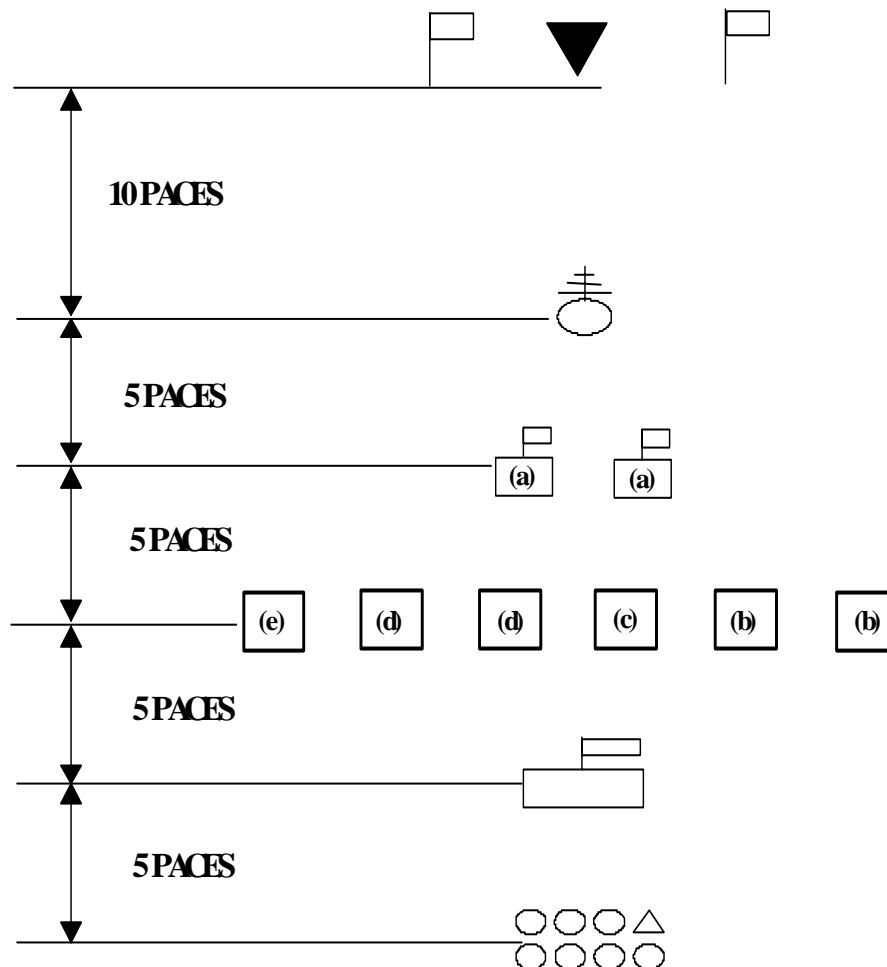

Figure 18-7.--Precedence for Combined Awards and Retirement Ceremonies.

e. The reviewing officer first awards the unit decoration, then the individual decorations and retirements.

f. When posting the colors, the unit colors receiving awards do not march forward until the person(s) receiving individual decorations and retiring have cleared their path. The award recipients and retirees march to their position in the reviewing area, and form a line at normal interval, to the left of the reviewing officer. (See figure 18-5.)

Note: Personnel in key billets who are called forward to receive an award will return to their position in formation once the award recipients have posted to the left of the reviewing officer.

#### 18006. BATTLE COLORS CEREMONY

1. This ceremony follows almost exactly the same sequence used for decorating colors in paragraph 18004. The difference is that it is designed to re-dedicate a unit's organizational colors. This is normally done when celebrating a unit's anniversary or when commemorating a specific battle in which the unit participated.

a. Prior to the start of the ceremony when the colors are being delivered to the color guard the individual streamers designating the units honors are removed from the organizational colors streamer attachment set.

b. Each streamer is given to a designated Marine who will deliver the streamer to the reviewing officer during the presentation portion of the ceremony.

c. Person(s) designated to deliver the streamers will form up in the same manner as retirees per paragraph 18003.1 as shown in figure 18-6. They fall in chronological order of issuance, the oldest streamer presented at the front.

2. Commander of troops commands **"Colors to be Re-dedicated and All Colors, Center, MARCH."**

a. On the command **"Colors,"** the color guard goes to carry colors and the staff goes to carry sword.

b. On the command **"Center,"** the staff executes a right face.

c. On the command **"MARCH,"** the staff steps off and moves forward approximately 10 paces, halts, executes a left face and goes to order sword.

d. The commander of troops, once the staff has cleared, marches forward to the color guard, halts 5 paces in front of them, salutes the colors, and faces about.

3. Commander of troops commands **"Forward, MARCH."**

a. The commander of troops and color guard march forward towards the reviewing area. The commander of troops commands **"Detachment, HALT"** so that the detail is halted with the commander of troops approximately 10 paces in front of and centered on the reviewing officer. The color guard remains at the carry.

b. The adjutant commands the staff to carry sword, left face and marches the staff back to its position, where the staff halts, faces the reviewing area and goes to order sword. The commander of troops then salutes the reviewing officer and reports, "**Sir/Ma'am, Colors to be Re-dedicated and All Colors are Present.**" The reviewing officer returns the commander of troops' salute.

4. Reviewing officer commands, "**PRESENT THE COMMAND.**" The commander of troops returns to the carry, steps right in marching and moves to a position in front of the staff, saluting the colors as he/she passes them, and halts facing the line of troops.

5. Commander of troops commands "**Present, ARMS.**" The unit executes. The commander of troops faces the reviewing area.

**NARRATOR: "LADIES AND GENTLEMEN PLEASE RISE FOR HONORS TO OUR NATIONAL COLORS."**

6. Commander of troops then commands "**Staff, Present, ARMS.**" The commander of troops and staff execute present sword.

a. The color guard riflemen execute present arms, from the carry.

→ b. On the first note of the "*National Anthem*" or "*To The Color*" the reviewing officer executes a hand salute and the organizational color bearer presents colors.

→ c. After the last note of the "*National Anthem*" or "*To The Color*" the organizational color bearer returns to the carry position. The reviewing officer terminates their salute.

7. Commander of troops commands "**Staff, Order, SWORD.**" The commander of troops, staff, and color guard go to the order. The commander of troops then goes to carry sword, and faces the line of troops.

**NARRATOR: "LADIES AND GENTLEMEN, PLEASE BE SEATED."**

8. Commander of troops commands "**Order, ARMS.**" The unit executes. The commander of troops then faces the reviewing area and goes to order sword.

9. The reviewing officer assisted by the sergeant major now moves forward to re-attach the streamers. The organizational color bearer dips the colors forward sufficiently, without the colors touching the ground, to allow the reviewing officer to reach the streamer attachment set. The reviewing officer then attaches each streamer to the colors as the narrator reads the citation for the streamer.

a. As the citation for each streamer is read the designated person(s) with that streamer will march forward and present the streamer to the reviewing officer. Once the streamer is attached this person(s) will leave the reviewing area and move behind the reviewing stands.

4. Once all streamers are re-attached the ceremony will proceed in the same manner as those outlined in paragraph 18004.

Enclosure (1)

MARINE CORPS DRILL AND CEREMONIES MANUAL

PART II: CEREMONIES

CHAPTER 19

CHANGE OF COMMAND CEREMONY

	<u>PARAGRAPH</u>	<u>PAGE</u>
GENERAL . . . . .	19000	19-3
OCCASION . . . . .	19001	19-3
FORMATION . . . . .	19002	19-3
SEQUENCE OF EVENTS FOR A CHANGE OF COMMAND WITHOUT PROMOTION, RETIREMENT OR AWARDS . . . . .	19003	19-3
SEQUENCE OF EVENTS FOR A CHANGE OF COMMAND WITH PROMOTION AND/OR PRESENTATION OF AWARDS . . . . .	19004	19-6
SEQUENCE OF EVENTS FOR A CHANGE OF COMMAND WITH PRESENTATION OF AWARDS AND/OR RETIREMENT . . . . .	19005	19-8
HONORS FOR GENERAL OFFICERS AND HIGH RANKING CIVILIANS PARTICIPATING IN THE CHANGE OF COMMAND . . . . .	19006	19-9

FIGURE

19-1	DELIVERING AND RETURNING THE COLORS. . . . .	19-5
------	--	------





MARINE CORPS DRILL AND CEREMONIES MANUAL

PART II: CEREMONIES

CHAPTER 19

CHANGE OF COMMAND CEREMONY

19000. GENERAL. Changes of command in the Marine Corps shall be conducted as prescribed in this Chapter. (The term "sergeant major" will reflect either the unit sergeant major or senior enlisted representative present.)

19001. OCCASION. When practicable, the ceremony set forth below will be held upon the change of command for an organization of battalion or squadron size, or larger units and directors of schools. The ceremony is normally a parade (see chapter 17), however, it may be a review or as simple as a formation of the unit affected.

19002. FORMATION

1. The command is formed for the appropriate ceremony (e.g., unit formation, review or parade) per chapter 16 and 17. When the selected ceremony reaches the point in time when the command is presented to the outgoing commander the sequence of events for the change of command as outlined in this Chapter will be followed.

2. The color guard is normally trooped as part of the sequence of events. However, if the incoming commander is being promoted at the parade or the outgoing commander is retiring or receiving an award during the parade, the color guard marches on with the formation and the colors are brought forward for the promotion/retirement/awards portion of the ceremony.

19003. SEQUENCE OF EVENTS FOR A CHANGE OF COMMAND WITHOUT PROMOTION, RETIREMENT OR AWARDS

1. The standard sequence for a change of command normally begins after the commander of troops has presented the command to the outgoing commander. On occasion, modifications to the normal sequence can take place, such as:

- a. The playing of "*Honors*," (or)
- b. "*Trooping the Line*" during a Review.

Note: In these cases, the commander of troops presents the command after completion of the scenarios described above.

2. The commander of troops, having placed the command at attention and order arms, faces the reviewing area. The incoming commander then takes the designated post in the reviewing area to the left and abreast of the outgoing commander. (See figure 19-1.)

3. Commander of troops commands "**Sergeant Major, Deliver the Colors to the Commanding Officer (General).**"

4. The sergeant major, who is positioned to the left of the reviewing stand, moves by the most direct route to the color guard, passing the commander of troops and staff on his/her own right.

a. Upon the commander of troop's command to the sergeant major, the color guard executes carry colors.

b. The sergeant major halts 1 pace in front of and centered on the color guard, and salutes the national colors. Once rendered, the Marine then takes one right step, while at the same time the organizational color bearer removes the organizational colors from the socket. The sergeant major grasps the organizational colors, (left hand at the base near the ferrule, right hand on the staff approximately eye level) and steps off to the right in marching.

c. The color guard remains at carry colors until the organizational colors is returned.

d. The sergeant major then marches to the reviewing area carrying the colors as close to the "carry colors" position as possible without a sling. The sergeant major passes the commander of troops and staff on his/her own right. The sergeant major halts approximately 2 paces in front of the outgoing commander. (See figure 19-1.)

5. Commander of troops commands "**Present, ARMS,**" as the sergeant major is approaching the staff, the commander of troops then faces the reviewing area.

6. Commander of troops commands "**Staff, Present, SWORD.**"

a. The staff executes. At this time the narrator will read the orders of the outgoing commander. The sergeant major then delivers the colors to the outgoing commander (the colors remaining in its most upright position), then executes one right step and salutes.

b. On the sergeant major's salute, the outgoing and incoming commanders face each other. At this time the narrator will read the orders of the incoming commander. The outgoing commander passes the colors to the incoming commander.

c. Both commanders then face front. The sergeant major cuts his/her salute and executes one right step. The incoming commander then returns the colors to the sergeant major.

d. The outgoing and incoming commanders then face each other, exchange salutes and handshakes, and exchange positions (right shoulder to right shoulder).

e. The sergeant major then steps off to the right as in marching and returns the colors to the color guard, passing the staff on his/her right. When arriving at the color guard the sergeant major halts centered on the color guard and returns the organizational colors. The sergeant major salutes steps to the right as in marching and moves by the most direct route from the field, passing the staff on his/her own right. (See figure 19-1.)

7. Commander of troops commands "**Staff, Order, SWORD,**" as the sergeant major is moving to return the organizational colors, the commander of troops and staff execute. The commander of troops faces the line of troops.

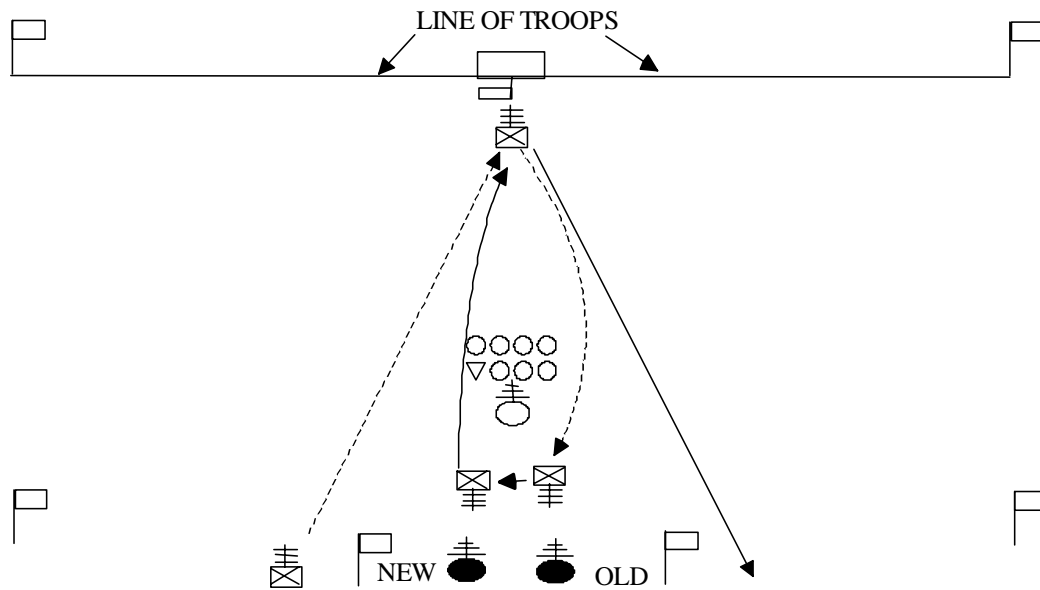

Figure 19-1.--Delivering and Returning the Colors.

8. Commander of troops commands **"Order, ARMS."** The unit executes order arms and/or carry sword.

a. The color guard remains at carry colors and receives the organizational colors from the sergeant major. The color guard then executes order colors. (If honors are to be played as the next sequence, the color guard will remain at carry colors.)

b. After the sergeant major has cleared the parade field the commander of troops will face the line of troops.

Note: If the incoming commander rates honors, continue with paragraph 19003.9. If the incoming commander does not rate honors continue with paragraph 19003.12.

9. Commander of troops commands **"Present, ARMS."** All execute, present arms/present sword.

10. Commander of troops commands (while facing the reviewing area) **"Staff, Present, SWORD."** The staff executes present sword.

**NARRATOR:** **"LADIES AND GENTLEMEN, PLEASE RISE FOR HONORS TO RANK AND NAME OF COMMANDER."** (The band plays appropriate honors and gun salutes are fired.)

Note: The organizational color bearer salutes on the first note and terminates on the last note (last gun) of honors. After honors are completed the narrator speaks.

**NARRATOR:** **"LADIES AND GENTLEMEN, PLEASE BE SEATED."**

11. Commander of troops commands **"Staff, Order, SWORD."** The commander of troops and staff execute. The commander of troops goes to carry sword and faces the line of troops.

12. Commander of troops commands **"Order, ARMS"** and **"Parade, REST."** The unit executes. The commander of troops then faces about.

13. Commander of troops commands **"Staff, Parade, REST."**

a. The staff and commander of troops execute.

b. The narrator then delivers a microphone (if available), to the outgoing commander. The commander makes remarks then passes the microphone to the incoming commander who makes his/her remarks. After the incoming commander's remarks the microphone is retrieved. Both commanders return to their positions in the reviewing area assuming the position of attention.

Note: If the reviewing officer or the senior officer present other than the commanders desire to make remarks, they will do so prior to the outgoing and incoming commanders.

14. Commander of troops commands **"Staff, ATTENTION."** The staff and commander of troops execute. The commander of troops goes to carry sword and faces the line of troops.

15. Commander of troops commands **"Battalion/Squadron, ATTENTION."** The unit executes. The commander of troops then faces the reviewing area.

16. Incoming Commander Commands

a. **"DISMISS THE COMMAND"** (or)

b. **"MARCH THE COMMAND IN REVIEW."**

Note: Follow remaining parade sequence for "Dismissing the Command" or "Pass in Review" as explained in chapter 17.

19004. SEQUENCE OF EVENTS FOR A CHANGE OF COMMAND WITH PROMOTION AND/OR PRESENTATION OF AWARDS

1. If the incoming commander is to be promoted as part of the ceremony, the colors are not trooped at the beginning of the parade sequence. The sequence of events begins after the change of command and the command has been presented to the "Promoting/Awarding Official," who is normally senior to both the incoming and outgoing commanders. After honors, if appropriate, (see paragraph 19003.9) are complete the unit is at order arms.

2. Commander of troops commands **"Officer to be Promoted, and All Colors, Center, MARCH."**

a. On the preparatory command **"Colors,"** the staff executes carry sword. On the command **"Center:"**

(1) The staff executes a right face, commander of troops commands **"MARCH,"** the staff marches 8-10 paces, halts, and executes a left face and goes to order sword all on command of the adjutant.

(2) The color guard executes carry colors.

(3) The commander of troops (once the staff has moved), marches to a point, 10 paces in front of the color guard, halts, salutes, and executes an about face.

b. On the command of execution **"MARCH:"**

(1) The commander of troops and the color guard step off and march forward to a point of approximately 10 paces in front of the promoting official. The commander being promoted then takes their position in front of the colors as described for retirees in chapter 18.

(2) As the color guard passes, the staff executes carry sword, left face and returns 8-10 paces to its previous position, executes a right face, and executes order sword all on command of the adjutant. The commander of troops salutes, and reports to the reviewing officer **"Sir/Ma'am, Officer(s) to be Promoted and All Colors are Present."**

3. Promoting official commands **"PRESENT THE COMMAND."** The commander of troops returns to carry sword, faces to the right as in marching, while passing the colors he/she executes present sword and returns to their position in the staff. Facing the line of troops.

4. Commander of troops commands **"Present, ARMS."** (Faces about and commands) **"Staff, Present, SWORD."** (The command is then presented for the *"National Anthem."*) After the last note;

5. After the last note, the commander of troops commands **"Staff, Order, ARMS."** Commander of troops executes carry sword, faces about and commands **"Order, ARMS."**

Note: As an option after the promotion or award is effected the "Promoting Official" may make remarks followed by the old and new commanders. Remarks are made at this time in place of remarks immediately following the passing of the organizational colors. If this option is used the commander of troops will place the command at **"Parade, REST"** until after the remarks then return the command to **"ATTENTION,"** and follow the remainder of the sequence below.

6. After the promotion or award is presented the reviewing officer moves back to the reviewing area and the sergeant major departs the field. The commander of troops, seeing the reviewing officer back in position goes to carry sword.

7. Commander of troops commands **"POST THE COLORS"** and **"Staff, Carry, SWORD."** The commander of troops and staff execute carry sword. The color guard executes carry colors.

8. Commander of troops commands **"Staff, Right, FACE"** and **"Staff, Forward, MARCH."** The commander of troops and staff execute.

a. Color guard executes a countermarch and moves back to its position on line of troops, countermarches, halts and goes to order colors. (See figure 18-4.)

b. The commander of troops and staff march forward sufficiently for the colors to pass, halts, does a left face and goes to order sword. When the colors have passed the commander of troops moves the staff back to its position, halts and

executes a right face and goes to order sword. However, the commander of troops faces the line of troops, remaining at carry sword. When the color guard is in position, and at order colors, the commander of troops faces the reviewing area.

9. Once the promotion or award is effected the outgoing commander takes his/her post in the reviewing area. The change of command then proceeds as described in paragraph 19003.16.

19005. SEQUENCE OF EVENTS FOR A CHANGE OF COMMAND WITH PRESENTATION OF AWARDS AND/OR RETIREMENT

1. If the outgoing commander is to receive an award and/or retire as part of the change of command ceremony, the colors are not trooped at the beginning of the parade ceremony. The sequence of events begins after the change of command and the commander of troops is facing the reviewing area. The "Retiring Official," who is normally senior to both the incoming and outgoing commanders takes his/her post in the reviewing area.

2. Commander of troops commands **"Officer(s) to be Retired, and All Colors, Center, MARCH."**

a. On the preparatory command **"Colors,"** the staff executes carry sword. On the command **"Center:"**

(1) The staff executes a right face, commander of troops commands **"MARCH,"** the staff marches 8-10 paces.

(2) The color guard executes carry colors.

(3) The commander of troops (once the staff has moved), marches to a point, 10 paces in front of the color guard, halts, salutes, and executes an about face.

b. On the command of execution **"MARCH:"**

(1) The commander of troops and the color guard step off and march forward to a point approximately 10 paces in front of the promoting official. The commander being retired then takes their position in front of the colors as described for retirees in chapter 18.

(2) As the color guard passes, the staff returns, as described in paragraph 14003.6, executes carry sword, left face and returns 8-10 paces to its previous position, and executes a right face and executes order sword. The commander of troops salutes, and reports to the reviewing officer **"Sir/Ma'am, All Officers to be Retired and All Colors are Present."**

3. Reviewing officer commands **"PRESENT THE COMMAND."** The commander of troops returns to carry sword, faces to the right as in marching while passing the colors he/she executes present sword and returns to their position in the staff, and facing the line of troops.

4. Commander of troops commands **"Present, ARMS."** (Faces about and commands) **"Staff, Present, SWORD."** (The command is then presented for the *"National Anthem."*)
5. After the last note, the commander of troops commands **"Staff, Order, ARMS."** Commander of troops executes carry sword, faces about and commands **"Order, ARMS."**
6. The award and/or retirement is affected per the procedures in chapter 18.

Note: As an option after the award or retirement is effected the "Retiring Official" may make remarks followed by the old and new commanders. Remarks are made at this time in place of remarks immediately following the passing of the organizational colors. If this option is used the commander of troops will place the command at **"Parade, REST"** until after the remarks then return the command to **"ATTENTION,"** and follow the remainder of the sequence below.

7. After the last award and/or retirement is effected the reviewing officer moves back to the reviewing area. The commander of troops, seeing the reviewing officer back in position, goes to carry sword.

8. Commander of troops commands **"POST THE COLORS"** and **"Staff, Carry, SWORD."** The commander of troops and staff execute carry sword. The color guard executes carry colors.

9. Commander of troops commands **"Staff, Right, FACE"** and **"Staff, Forward, MARCH."** The commander of troops and staff execute.

a. Color guard executes a countermarch and moves back to its position on the line of troops, countermarches, halts and goes to order colors. (See figure 18-4.)

b. The commander of troops and staff march forward sufficiently, as described in paragraph 14003.8b, for the colors to pass, halts, does a left face and goes to order sword. When the colors have passed the commander of troops moves the staff back to its position, halts and executes a right face and goes to order sword. However, the commander of troops faces the line of troops, remaining at carry sword. When the color guard is in position, and at order color, the commander of troops faces the reviewing area.

10. Once colors are returned to the line of troops, the outgoing and incoming commanders take their post in the reviewing area. The command is then marched in review or dismissed.

19006. HONORS FOR GENERAL OFFICERS AND HIGH RANKING CIVILIANS PARTICIPATING IN THE CHANGE OF COMMAND

1. It is not unusual for general officers and high ranking civilians to observe change of command ceremony as invited guests. Unless they are participating in the ceremony as the Promoting/Retiring Official, honors are not rendered since the outgoing and incoming commanders during their remarks recognize them. If participating the following procedures will be used.

a. When the selected ceremony reaches the point in time when the command is presented to the outgoing commander the command is instead presented to the general officer. The narrator would introduce the general officer by announcing.



**NARRATOR: "LADIES AND GENTLEMEN, PLEASE RISE FOR HONORS TO \_\_\_\_\_"**  
(e.g., The Commanding General, Second Marine Division, Major General Smith).

b. The command is presented and honors are rendered.

**NARRATOR: "LADIES AND GENTLEMEN PLEASE BE SEATED."**

c. The general officer returns to his/her seat in the reviewing stand.

d. The command is then placed at the order and the commander of troops faces the reviewing area. The outgoing commander then moves to their position in the reviewing area and the change of command resumes its normal sequence.

e. The change of command then proceeds as outlined in paragraph 19003.

MARINE CORPS DRILL AND CEREMONIES MANUAL

PART II: CEREMONIES

CHAPTER 20

RELIEF AND APPOINTMENT OF THE SERGEANT MAJOR

	<u>PARAGRAPH</u>	<u>PAGE</u>
GENERAL . . . . .	20000	20-3
OCCASION . . . . .	20001	20-3
FORMATION . . . . .	20002	20-3
SEQUENCE OF EVENTS FOR THE RELIEF AND APPOINTMENT CEREMONY WITHOUT AN AWARD, PROMOTION OR RETIREMENT . . . . .	20003	20-3
SEQUENCE OF EVENTS FOR THE RELIEF AND APPOINTMENT CEREMONY WITH A PROMOTION AND/OR PRESENTATION OF AWARDS . . . . .	20004	20-5
SEQUENCE OF EVENTS FOR THE RELIEF AND APPOINTMENT CEREMONY WITH PRESENTATION OF AWARDS AND/OR RETIREMENT . . . . .	20005	20-7

FIGURE

20-1	SERGEANTS MAJOR TAKE POSITION . . . . .	20-4
20-2	POSITION OF THE SERGEANTS MAJOR AFTER RELIEF AND APPOINTMENT . . . . .	20-5



MARINE CORPS DRILL AND CEREMONIES MANUAL

PART II: CEREMONIES

CHAPTER 20

RELIEF AND APPOINTMENT OF THE SERGEANT MAJOR

20000. GENERAL. Ceremonies for relief and appointment of sergeants major in the Marine Corps shall be conducted as prescribed in this Chapter.

20001. OCCASION. When practicable, the ceremony set forth below will be held upon the relief of the old and appointment of the new sergeant major within units of battalion or squadron size and larger. The ceremony may be as simple as a formation of the unit affected a review or a parade. For example, if the old sergeant major is transferring then a formation or review is appropriate. If the old sergeant major is retiring then a retirement parade in conjunction with the relief and appointment ceremony is appropriate.

20002. FORMATION

1. The command is formed for the appropriate ceremony (e.g., unit formation, parade or review) per chapters 11, 12, 16 and/or 17.

2. If no award, promotion or retirement is effected as part of the ceremony then the colors will be trooped.

20003. SEQUENCE OF EVENTS FOR THE RELIEF AND APPOINTMENT CEREMONY WITHOUT AN AWARD, PROMOTION OR RETIREMENT

1. The sequence for the relief and appointment of the sergeants major begins after the commander of troops has presented the command to the unit commander and the command is back at order arms if a parade, or after trooping the line if a review.

2. Commander of troops commands **"Sergeants Major, Front and Center, MARCH."**

→ 3. The sergeants major moves from their seats in the reviewing stand to positions five paces in front of the reviewing area, the old sergeant major on the right. (See figure 20-1.) The old sergeant major will carry the sword of office in the unrigged carry position under the left arm as prescribed in figure 5-18.

Note: The old and new sergeants major will only exchange a noncommissioned officer's sword. The exchange of k-bar knives, swagger sticks, or any other form of symbolism, is expressly forbidden.

**NARRATOR: SINCE 1875 NONCOMMISSIONED AND STAFF NONCOMMISSIONED OFFICERS HAVE CARRIED THE NONCOMMISSIONED OFFICER SWORD AS A SYMBOL OF THEIR ABILITY AND PRESTIGE AS ENLISTED LEADERS OF THE MARINE CORPS. THE SERGEANT MAJOR AS THE SENIOR ENLISTED LEADER AND ADVISOR IS THE KEEPER OF TRADITIONS FOR HIS/HER UNIT. TODAY'S EMBLEMATIC PASSING OF THE SWORD OF OFFICE SIGNIFIES THE TRANSFER OF THIS SACRED TRUST FROM ONE SERGEANT MAJOR TO ANOTHER.**

Enclosure (1)

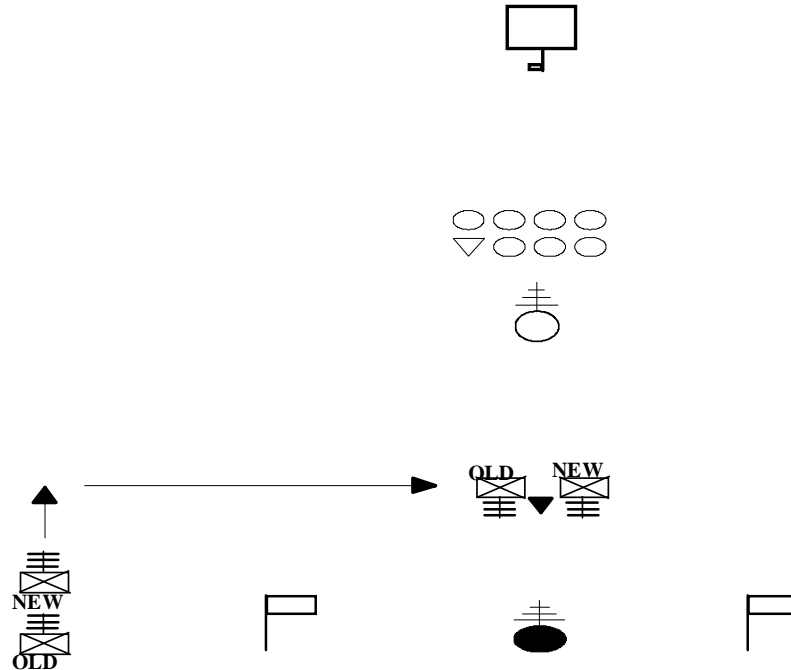

Figure 20-1.--Sergeants Major take Position.

#### 4. Relief and Appointment

➔ **NARRATOR: READS THE ORDERS FOR THE OUTGOING SERGEANT MAJOR.**

- ➔ a. The old sergeant major then steps front and center of the unit commander, salute and reports **"Sir/Ma'am, Sergeant Major \_\_\_\_\_ reporting as the old sergeant major."** The unit commander returns the salute and states **"You are relieved."** The old sergeant major then yields the responsibility of his/her post by surrendering the sword of office to the unit commander, who places it at unrigged carry. The old sergeant major then moves to his/her new position approximately 3 paces to the left and abreast of the unit commander. (See figure 20-2.)

**NARRATOR: READS THE ORDERS FOR THE INCOMING SERGEANT MAJOR.**

- b. The new sergeant major then steps front and center of the unit commander, salutes and reports **"Sir/Ma'am, Sergeant Major \_\_\_\_\_ reporting as the new sergeant major."** The unit commander returns the salute and passes the sword to the new sergeant major, who assumes the unrigged carry. The unit commander then states **"TAKE YOUR POST."** The new sergeant major then moves to his/her position between the unit commander and old sergeant major. The staff noncommissioned officer/noncommissioned officer designated to retrieve the sword then moves behind the new sergeant major, takes the sword, places it at the unrigged carry and marches from the field. (See figure 20-2.)

5. Commander of troops commands **"Parade, REST."** The command executes parade rest. The commander of troops then faces the reviewing area.

6. Commander of troops commands **"Staff, Parade, REST."** The commander of troops, staff, color guard, unit commander and sergeants major execute parade rest. The

Enclosure (1)

20-4

Ch 1

microphone is delivered to the unit commander who makes their remarks. The microphone is then passed to the old sergeant major for remarks and then the new sergeant major for remarks. Once all remarks are completed the microphone is retrieved.

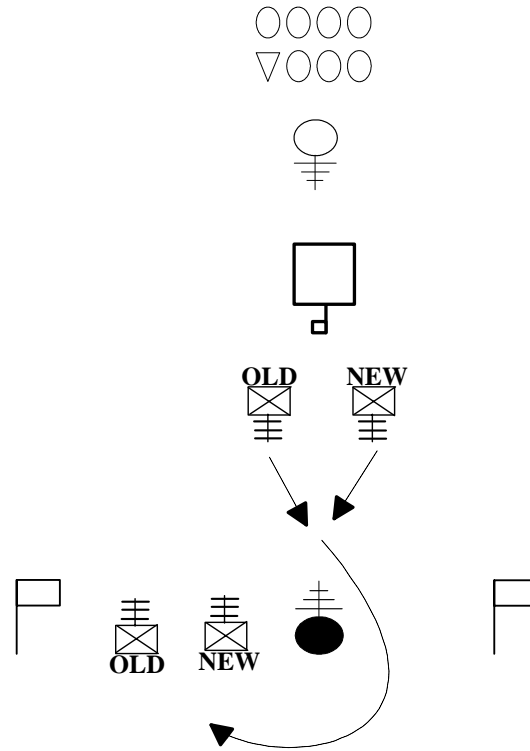

Figure 20-2.--Position of the Sergeants Major after Relief and Appointment.

7. Commander of troops commands "**Staff, ATTENTION.**" The commander of troops, staff, color guard, unit commander and sergeants major execute attention. The commander of troops then faces the line of troops.
8. Commander of troops commands "**Battalion, ATTENTION.**" The battalion executes attention. The commander of troops then faces the reviewing area.
9. The ceremony would then continue as prescribe for a review (see chapter 16), a parade (see chapter 17) or unit formation (e.g., the command is marched in review, dismissed, etc.).

20004. SEQUENCE OF EVENTS FOR THE RELIEF AND APPOINTMENT CEREMONY WITH A PROMOTION AND/OR PRESENTATION OF AWARDS

1. If the incoming sergeant major is to be promoted as part of the ceremony, the colors are not trooped at the beginning of the parade sequence. The sequence of events begins after the change of command and the command has been presented to the "Promoting Official." After honors, if appropriate, are complete the unit is at order arms.

2. Commander of troops commands **"Personnel to be Promoted, and All Colors, Center, MARCH."**

a. On the preparatory command **"Colors,"** the staff executes carry sword. On the command **"Center:"**

(1) The staff executes a right face, commander of troops commands **"MARCH,"** the staff marches, as described in paragraph 14003.c through 14003.f, 8-10 paces, halts, and executes a left face and goes to order sword.

(2) The color guard executes carry colors.

(3) The commander of troops (once the staff has moved), marches to a point, 10 paces in front of the color guard, halts, salutes, and executes an about face.

b. On the command of execution **"March:"**

(1) The commander of troops and the color guard step off and march forward to a point of approximately 10 paces in front of the promoting official. The person being promoted then takes his/her position in front of the colors as described for retirees in chapter 18.

(2) As the color guard passes, the staff returns to its position, as described in paragraph 14006, executes carry sword, left face and returns 8-10 paces to its previous position, returns to its position as described in paragraph 14006 executes a right face, and executes order sword. The commander of troops salutes, and reports to the reviewing officer **"Sir/Ma'am, Personnel to be Promoted and All Colors are Present."**

3. Promoting official commands, **"PRESENT THE COMMAND."** The commander of troops returns to carry sword, faces to the right as in marching, while passing the colors he/she executes present sword, returns to their position in the staff, and faces the line of troops.

4. Commander of troops commands **"Present, ARMS."** (Faces about and commands) **"Staff, Present, SWORD."** (The command is then presented for the "National Anthem.")

→ 5. After the last note, the commander of troops commands **"Staff, Order, ARMS."** Commander of troops executes carry sword, faces about and commands **"Order, ARMS."**

Note: As an option after the promotion or award is effected the "Promoting Official" may make remarks followed by the old and new sergeants major. Remarks are made at this time in place of remarks immediately following the passing of the sword of office. If this option is used the commander of troops will place the command at **"Parade, REST"** until after the remarks then return the command to **"ATTENTION,"** and follow the remainder of the sequence below.

6. After the promotion or award is presented the reviewing officer moves back to the reviewing area and the sergeants major post to the reviewing officers left. The commander of troops, seeing the reviewing officer back in position goes to carry sword.

7. Commander of troops commands **"POST THE COLORS"** and **"Staff, Carry, SWORD."** The commander of troops and staff execute carry swords. The color guard executes carry colors.

Enclosure

8. Commander of troops commands **"Staff, Right, FACE"** and **"Staff, Forward, MARCH."** The commander of troops and staff execute.

a. Color guard executes a countermarch and moves back to its position on line of troops, countermarches, halts and goes to order colors. (See figure 18-4.)

b. The commander of troops and staff march, as described in paragraph 14008, forward sufficiently for the colors to pass, halts, does a left face and goes to order sword. When the colors have passed the commander of troops moves the staff back to its position, halts and executes a right face and goes to order sword. However, the commander of troops faces the line of troops, remaining at carry sword. When the color guard is in position, and at order colors, the commander of troops faces the reviewing area.

9. The ceremony would then continue as prescribe for a review (see chapter 16), a parade (see chapter 17) or unit formation (e.g., the command is marched in review, dismissed, etc.).

20005. SEQUENCE OF EVENTS FOR THE RELIEF AND APPOINTMENT CEREMONY WITH PRESENTATION OF AWARDS AND/OR RETIREMENT

1. If the outgoing sergeant major is to receive an award and/or retire as part of the change of command ceremony, the colors are not trooped at the beginning of the parade ceremony. The sequence of events begins after the relief and appointment and the commander of troops is facing the reviewing area in paragraph 20004.2. The "Retiring Official," takes his/her post in the reviewing area.

2. Commander of troops commands **"Personnel to be Retired, and All Colors, Center."**

a. On the preparatory command **"Colors,"** the staff executes carry sword. On the command **"Center:"**

(1) The staff executes a right face, commander of troops commands **"MARCH,"** the staff marches 8-10 paces, halts, and executes a left face and goes to order sword.

(2) The color guard executes carry colors.

(3) The commander of troops (once the staff has moved), marches to a point, 10 paces in front of the color guard, halts, salutes, and executes an about face.

b. On the command of execution **"MARCH:"**

(1) The commander of troops and the color guard step off and march forward to a point approximately 10 paces in front of the retiring official. The sergeant major being retired then takes his/her position in front of the colors as described for retirees in chapter 18.

(2) As the color guard passes, the staff executes carry sword, left face and returns 8-10 paces, as described in paragraph 14003.c through 14003.f, to its previous position, and executes a right face and executes order sword. The commander of troops salutes, and reports to the reviewing officer **"Sir/Ma'am, Personnel to be Retired and All Colors are Present."**



3. Reviewing officer commands, "**PRESENT THE COMMAND.**" The commander of troops returns to carry sword, faces to the right as in marching, while passing the colors he/she executes present sword, returns to his/her position in the staff, and faces the line of troops.

4. Commander of troops commands "**Present, ARMS.**" (Faces about and commands.) "**Staff, Present, SWORD.**" (The command is then presented for the "*National Anthem.*")

5. After the last note, the commander of troops commands "**Staff, Order, ARMS.**" Commander of troops executes carry sword, faces about and commands "**Order, ARMS.**"

→ 6. The award and/or retirement is effected per the procedures in chapter 18.

Note: As an option the new sergeant major may make his/her remarks immediately following the post and relief. After the award or retirement is effected the "Retiring Official" may make remarks followed by the old sergeant major. This allows the old sergeant major the option of speaking last during his/her retirement ceremony. If this option is used the commander of troops will place the command at "**Parade, REST**" until after the remarks then return the command to "**ATTENTION,**" and follow the remainder of the sequence below.

7. After the last award and/or retirement is effected the reviewing officer moves back to the reviewing area, the sergeants major post to his/her left and the commander of troops, seeing the reviewing officer back in position, goes to carry sword.

8. Commander of troops command "**POST THE COLORS**" and "**Staff, Carry, SWORD.**" The commander of troops and staff execute carry sword. The color guard executes carry colors.

9. Commander of troops commands "**Staff, Right, FACE**" and "**Staff, Forward, MARCH.**" The commander of troops and staff execute.

a. Color guard executes a countermarch and moves back to its position on the line of troops, countermarches, halts and goes to order colors. (See figure 18-4.)

b. The commander of troops and staff march forward, as described in paragraph 14008, sufficiently for the colors to pass, halts, does a left face and goes to order sword. When the colors have passed the commander of troops moves the staff back to its position, halts and executes a right face and goes to order sword. However, the commander of troops faces the line of troops, remaining at carry sword. When the color guard is in position, and at order colors, the commander of troops faces the reviewing area.

10. Once colors are returned to the line of troops, the old and new sergeants major take their post in the reviewing area. The command is then marched in review or dismissed.

11. The ceremony would then continue as prescribe for a review (see chapter 16), a parade (see chapter 17) or unit formation (e.g., the command is marched in review, dismissed, etc.).

Enclosure (1)

MARINE CORPS DRILL AND CEREMONIES MANUAL

PART II: CEREMONIES

CHAPTER 21

ACTIVATION AND DEACTIVATION CEREMONY

	<u>PARAGRAPH</u>	<u>PAGE</u>
GENERAL . . . . .	21000	21-3
ACTIVATION OF AN ORGANIZATION . . . . .	21001	21-3
DEACTIVATION OF AN ORGANIZATION . . . . .	21002	21-4
JOINT DEACTIVATION AND ACTIVATION CEREMONY . . . . .	21003	21-6

FIGURE

21-1	RETIRE THE GUIDONS . . . . .	21-5
21-2	COLORS CENTER. . . . .	21-8
21-3	POST THE GUIDONS . . . . .	21-9



MARINE CORPS DRILL AND CEREMONIES MANUAL

PART II: CEREMONIES

CHAPTER 21

ACTIVATION AND DEACTIVATION CEREMONY

21000. GENERAL. On the occasion that Marine Corps organizations of battalion or squadron size and larger are activated or deactivated, the ceremonies in this Chapter will be used as guidelines. The term sergeant major refers to either the unit level sergeant major or the senior enlisted representative of the unit.

21001. ACTIVATION OF AN ORGANIZATION

1. The preferred ceremony for the activation of an organization is a parade. The troops are marched on as described in chapter 17.
2. The colors march on with the command and the national and organizational colors cased.
3. After presenting the command to the commander or officer activating the unit, the command is returned to the order.
4. Commander of troops commands **"All Colors, Center, MARCH."**

a. The commander of troops moves to bring the colors forward as described in paragraphs 18004.1 and 18004.2. When the colors are forward, the commander of troops salutes the commander and reports **"Sir/Ma'am, (Units designation) Colors are Present."**

b. The commander or officer activating the unit and sergeant major move forward to the color guard. As they approach the color guard the national and organizational color bearers take the colors from the sling and lowers them sufficiently for the commander, assisted by the sergeant major, to uncase the national and organizational colors. As the colors are uncased;

**NARRATOR READS PERTINENT EXTRACTS FROM THE ORDERS ACTIVATING THE UNIT.**

c. After the colors are uncased the color bearers returns them to the carry. The commander returns to his/her post and the sergeant major departs from the field.

5. Commander commands **"POST THE GUIDONS."** The guidon bearers march to a position in front of their respective company commanders. The company commanders will unfurl the guidons and the guidon bearers will return to their normal position 1 pace to the left and back of the company commanders.

Note: The company guidon bearers will begin the ceremonies and up to this point with their guidons furled.

6. Commander commands, **"PRESENT THE COMMAND."** The commander of troops conducts present the command as outlined in paragraph 18004.3.

a. Band plays *"National Anthem."*

b. After the command is presented and brought back to the order it is placed at parade rest and the commander or other officials deliver remarks.

c. After all remarks are completed, the command is brought to attention, the colors are posted and a march in review as described in chapter 17 conducted.

#### 21002. DEACTIVATION OF AN ORGANIZATION

1. The preferred ceremony for the deactivation of an organization is a review. The troops are unarmed and formed prior to the review as described in paragraph 16006. During the review no awards are issued and the colors are not brought forward. While the line is being trooped the narrator would read the lineage, honors and brief history of the unit. After the commander has finished trooping the line, and the command is back at attention, the commander directs the commander of troops to **"MARCH THE COMMAND IN FINAL REVIEW."** The command marches in review as described in chapter 17, however, after marching in review the command reforms on the line of troops. After the unit has reformed, the band, commander of troops and staff are returned to their original position.

2. Commander of troops commands **"All Colors, Center, MARCH."** The commander of troops moves to bring the colors forward as described in paragraphs 18004.1 and 18004.2. When the colors are forward, the commander of troops salutes the commander and reports **"Sir/Ma'am, (Units designation) Colors are Present."**

3. Commander commands, **"PRESENT THE COMMAND."** The commander of troops moves to present the command as outlined in paragraph 18004.3.

a. Band plays *"National Anthem."*

b. After the command is presented, brought back to the order and placed at parade rest, the commander or other officials deliver remarks.

4. After all remarks are completed the command is brought back to attention. The commander of troops then directs that the company/battery guidons be retired by commanding **"Retire, GUIDONS."** (See figure 21-1.) On this command unit first sergeants move from their position in the formation by the most direct route and to a position 1 pace in front of and facing the guidon bearer. The guidon is passed to the first sergeant. After receiving the guidon the first sergeants face about and march by the most direct route to their designated position on either side of the reviewing area where guidon stands have been staged. They halt together, place the guidons in the stands, face about and return to their position in the formation.

5. Once the first sergeants have returned to their position in the formation the color guard goes to the carry. The commander and sergeant major move forward to the color guard. As they approach the color guard the national and organizational color bearers take the colors from the slings and lower them sufficiently for the commander assisted by the sergeant major, to case the national and organization's colors. As the colors are being cased;

**NARRATOR READS PERTINENT EXTRACTS FROM THE ORDERS DEACTIVATING THE ORGANIZATION.  
(REFER TO UNITS MCBUL 5400 SERIES.)**

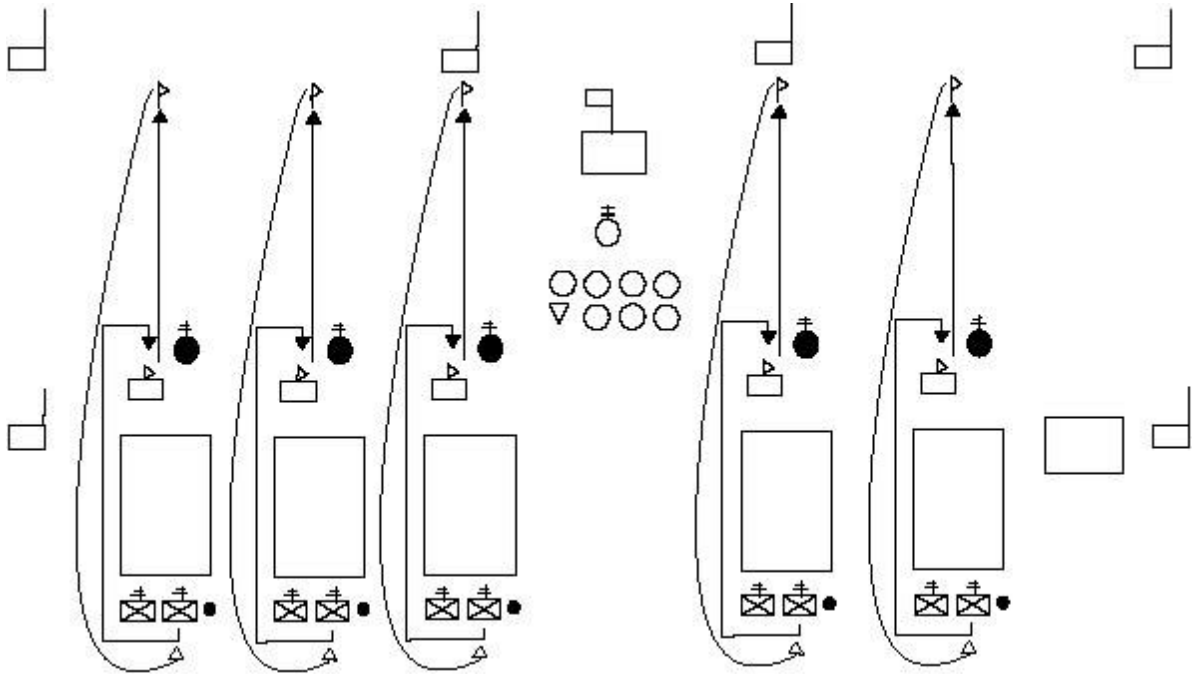

Figure 21-1.--Retire the Guidons.

6. When the colors are cased the national and organizational color bearer returns to the carry and the commander and sergeant major return to their posts.
7. Commander commands **"RETIRE THE COLORS."** The color guard executes a countermarch and halts facing the line of troops.
  - a. The commander of troops then presents the command.
  - b. The color guard executes a right turn and marches from the field while the band plays martial music.
  - c. After the color guard has cleared the field the commander of troops brings the command to the order and faces the commander.
8. Commander commands **"DISMISS THE BATTALION."**
9. The commander of troops and commander exchange salutes. The commander of troops then faces the line of troops and orders the company commanders to dismiss their companies. Salutes are exchanged between the company commanders and commander of troops. The commander of troops then dismisses the staff and the company commanders dismiss their companies, in sequence, from right to left.
10. The band plays "Auld Lang Syne" and retires from the field.
11. The narrator announces the end of the ceremony.

21003. JOINT DEACTIVATION AND ACTIVATION CEREMONY

1. On the occasion when two Marine Corps organizations of battalion or squadron size and larger are merged in to one larger organization, the ceremony in this Chapter will be used as a guideline.
2. The preferred ceremony for the activation of an organization is a parade. The troops are marched on as described in chapter 17 for a regimental parade.
3. The next higher headquarters of both merging units will conduct the parade and will normally be done using the procedures for a regimental formation as described in chapter 17.
4. The colors of the next higher unit will be used for the ceremony with those of the merging units uncased and massed behind the color guard per the procedures in chapter 7. The colors of the new unit to be formed by the merger will be cased and centered between the retiring colors in the mass colors formation. The colors will march on with the command.
5. The parade will be conducted as prescribed in chapter 17 up to the and including the presentation of the command and honors. After honors the commander of troops commands. **"All Colors, Center, MARCH."** On the command **"Colors,"** the color guard goes to carry colors and the staff goes to carry sword.
  - a. On the command **"Center,"** the staff executes a right face.
  - b. On the command **"MARCH,"** the staff steps off and moves forward 8-10 paces, halts, executes a left face and goes to order sword.
  - c. The colors being retired and the colors of the new unit step off and march to a position 5 paces in front of and centered on the color guard.
  - d. The commander of troops, once the staff has clear, marches forward to the line of organizational colors, halts 5 paces in front of them, salutes the colors, and faces about.
6. Commander of troops commands **"Forward, MARCH."**
  - a. The commander of troops, colors to be retired and uncased, and the color guard march forward towards the reviewing area. The commander of troops commands **"Detachment, HALT"** so that the detail is halted with the commander of troops 5 paces in front of and centered on the reviewing officer. (See figure 18-4.) The color guard remains at the carry. (See figure 21-2.)
  - b. The adjutant commands the staff to carry sword, left face and marches the staff back to its position, where the staff halts, faces the reviewing area and goes to order sword. The commander of troops then salutes the reviewing officer and reports **"Sir/Ma'am, all Colors are Present."** The commander returns the commander of troops' salute.
7. Commander commands, **"PRESENT THE COMMAND."** The commander of troops moves to present the command as outlined in paragraph 18004.3.
  - a. Band plays *"National Anthem."*

b. After the command is presented, brought back to the order and placed at parade rest, the commander of troops commands **"Retire, GUIDONS."** (See figure 21-1.)

c. On this command unit first sergeants move from their position in the formation by the most direct route and to a position 1 pace in front of and facing the guidon bearer. The guidon is passed to the first sergeant. After receiving the guidon the first sergeants faces about and march by the most direct route to their designated position on either side of the reviewing area where guidon stands have been staged. They halt together, place the guidons in the stands, face about and remain at their position in front of the guidons (except the first sergeant of the Headquarters and Service Company of the left battalion who will return to his/her normal position in the formation.)

Note: These will be double guidon stands with an empty side (left) for the retired guidon and the guidon for the newly activated unit pre-staged on the right. The guidon for the newly activated unit will be furled.)

8. At this time simultaneously, the organizational colors of the merging units will be retired.

a. The commanders from both deactivating units will step forward and assisted by the sergeant major will case their organizational colors. As they approach the color guard the organizational color bearer takes the colors from the sling and lowers it sufficiently for the commander, assisted by the sergeant major, to case the organization's colors. As the colors are cased; **NARRATOR READS PERTINENT EXTRACTS FROM THE ORDERS DEACTIVATING THE UNITS.**

b. The band plays "*Auld Lang Syne*" as the colors are cased.

c. After the colors are cased the color bearer returns them to the carry and then passes the colors to the sergeant major. The sergeants major march from the field with the cased colors followed by the color bearer. The commanders return to their post.

9. Once the colors are cased the unit may be placed at parade rest and remarks made by the reviewing officer and/or the commanding officers of the two units that have been deactivated. Following remarks the old commanders return to their seats. After these remarks the unit is brought back to attention.

10. The commander or officer activating the unit and sergeant major move forward to the color guard. As they approach the color guard the organizational color bearer takes the cased colors from the sling and lowers it sufficiently for the commander, assisted by the sergeant major, to uncase the organization's colors. As the colors are uncased;

**NARRATOR READS PERTINENT EXTRACTS FROM THE ORDERS ACTIVATING THE UNIT.**

After the new organizational color is uncased the color bearer returns it to the carry. The commander returns to his/her post and the sergeant major departs from the field.



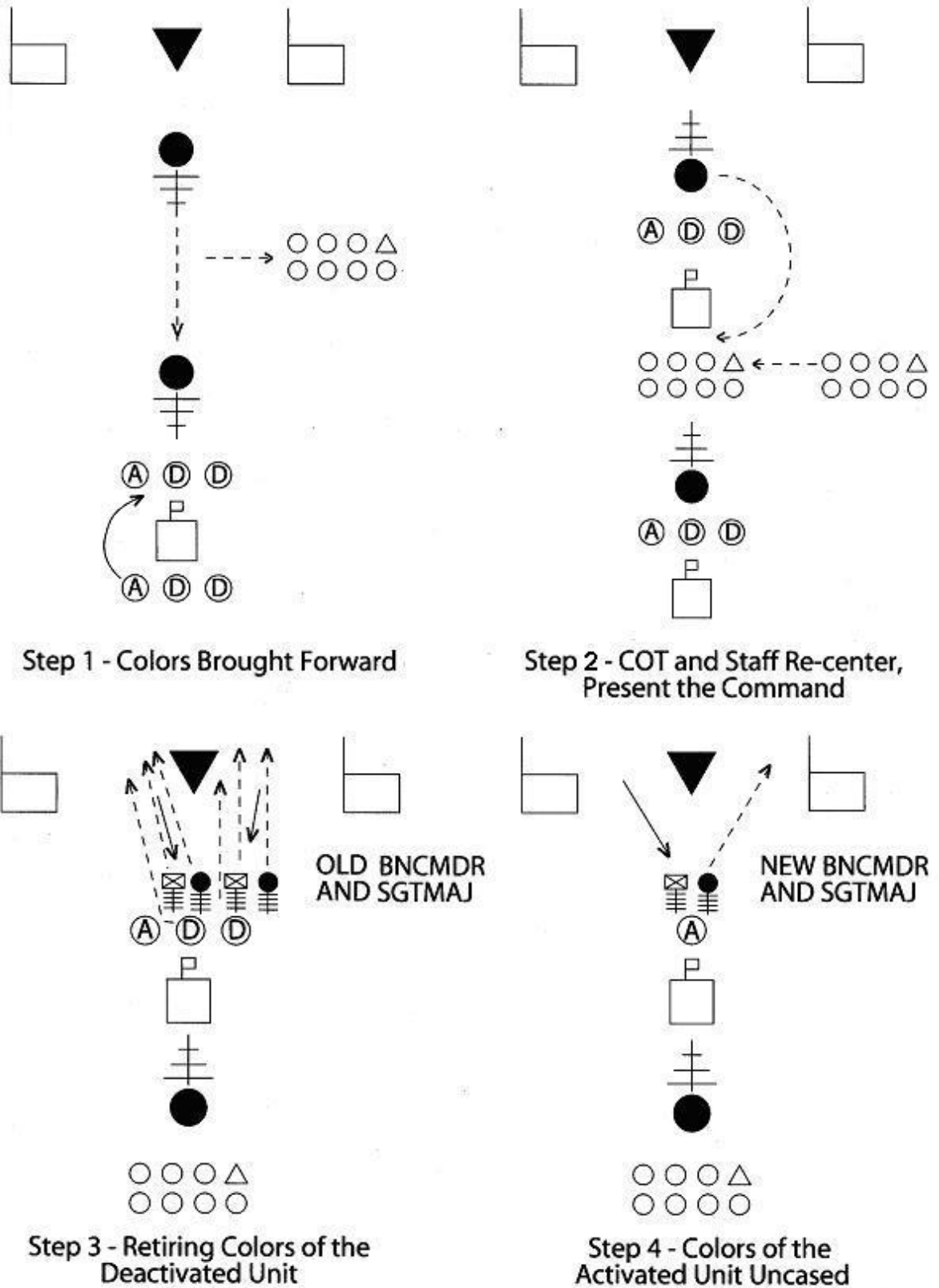

Figure 21-2.--Colors Center.

11. Commander commands **"POST THE GUIDONS."** The first sergeants face about and remove the new unit guidons from their position in the stand, unfurl it and march together by the most direct route to a position directly in front of the appropriate guidon bearer. (See figure 21-3.) They will pass the new guidon to the guidon bearer and then return to their normal position in the formation.

Note: At the start of this ceremony the two deactivating units each have a Headquarters and Service Company. Once the merger has occurred and the new unit activated the Headquarters and Service Company of the right battalion becomes the new Headquarters and Service Company.

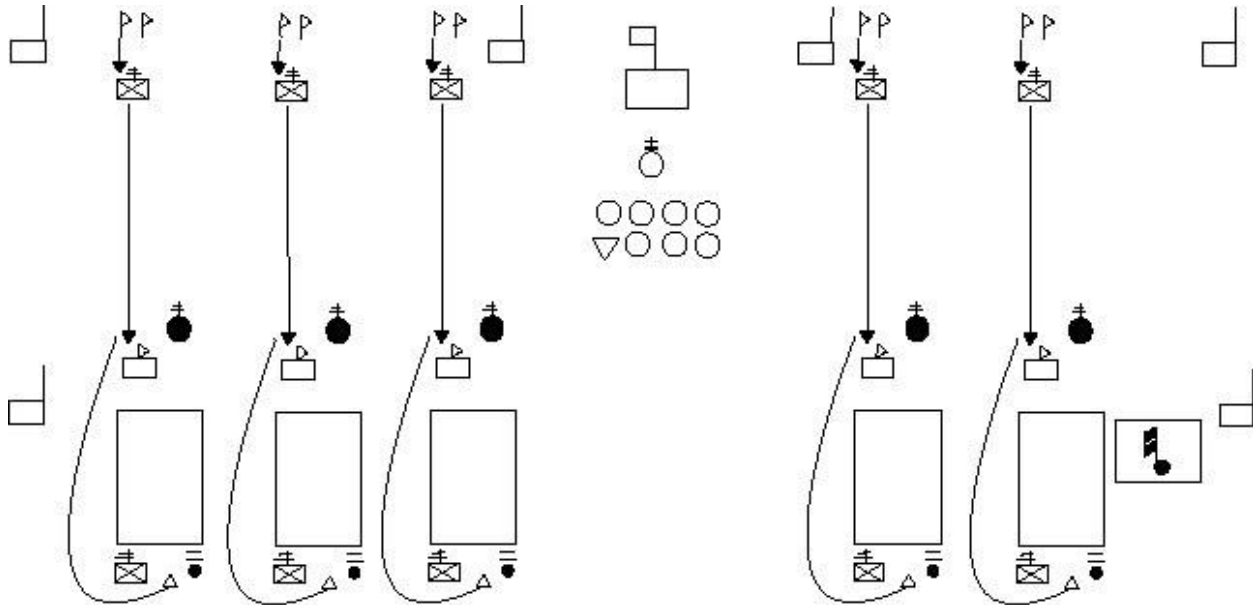

Figure 21-3.--Post the Guidons.

12. Commander commands **"PRESENT THE COMMAND."**

a. The commander of troops will present the command as outlined in paragraph 17006. After the command is presented and brought back to the order it is placed at parade rest and the new commander delivers remarks.

b. After all remarks are completed the command is brought to attention and the colors are posted. The new unit's organizational colors will follow the color guard back to the line of troops and when the color guard countermarches, the organizational colors will march around and resume its position in the formation behind the color guard.

13. At this point the command will march in review as described in chapter 17.

MARINE CORPS DRILL AND CEREMONIES MANUAL

SECTION II: CEREMONIES

CHAPTER 22

HONORS

	<u>PARAGRAPH</u>	<u>PAGE</u>
PRESCRIBED HONORS . . . . .	22000	22-3
RENDERING HONORS TO PERSONAGES ARRIVING FOR OFFICIAL VISITS ASHORE . . . . .	22001	22-3
RENDERING HONORS TO PERSONAGES DEPARTING AFTER OFFICIAL VISITS ASHORE . . . . .	22002	22-7
ESCORT OF HONOR . . . . .	22003	22-8
ADDITIONAL HONORS . . . . .	22004	22-8
GUN SALUTE . . . . .	22005	22-8
HONORS FOR OFFICIAL VISITS OF UNITED STATES OFFICERS (ARTICLE 1035) . . . . .	22006	22-11

FIGURE

22-1	HONORS MATRIX . . . . .	22-11
------	-------------------------	-------



MARINE CORPS DRILL AND CEREMONIES MANUAL

SECTION II: CEREMONIES

CHAPTER 22

HONORS

22000. PRESCRIBED HONORS

1. See *U.S. Navy Regulations* for tables of prescribed honors to be rendered afloat.
2. Except as set forth below, the same salutes, honors, and ceremonies, insofar as practicable, are rendered in connection with official visits to Naval stations and Marine Corps posts and bases as are rendered on similar visits to Navy ships.
3. Normally, a unit other than the interior guard will be detailed as the honor guard at shore-based establishments.
  - a. For a personage who merits a full guard, the honor guard will usually consist of at least two platoons of riflemen, a band and colors.
  - b. If sufficient personnel are not available to meet this requirement, the full guard will consist of not less than one platoon of riflemen.
  - c. For a personage who merits the guard of the day, the honor guard will consist of one platoon of riflemen.
  - d. The band and colors will not be included unless the guard consists of at least two platoons.
4. The following elements required in honors afloat are omitted when rendering honors ashore:
  - a. Manning the rail.
  - b. Piping alongside or over the side.
  - c. Side boys.
5. Only persons who are entitled honors and actually participate in any of the ceremonies described in chapter 15 will be accorded honors during the ceremony. If several persons rate honors are participating in the same ceremony then normally only the senior will receive honors. The exception to this is during a change of command when multiple honors may be appropriate.
6. The senior person participating has the option of differing honors to another that is also participating. Also, a person entitled to honors may differ a gun salute and elect instead to receive only musical honors.

22001. RENDERING HONORS TO PERSONAGES ARRIVING FOR OFFICIAL VISITS ASHORE

1. See *U.S. Navy Regulations* for the appropriate musical honors, gun salutes and display of personal or national flags.

2. Officers and noncommissioned officers will normally be armed with the sword for these ceremonies. At such locations where the sword is not required, or available, those individuals will be armed with the pistol. Personnel so armed will execute the hand salute in lieu of present sword, and during the inspection of the honor guard, will execute inspection arms as the personage halts at their position.

3. The commanding officer, senior officer present, or the representative of either, is the host and participates in the ceremony described herein. The commander ascertains from the visiting personage whether he/she desires to inspect the honor guard, or to pass around the honor guard as in a review, or to do neither. The commander also ascertains from the visiting personage whether, following any of the three alternatives above, he/she desires the honor guard to march in review, or does not so desire. The commander then advises the personage of the action to be taken in the ceremony.

4. Prior to the arrival of the visiting personage, the honor guard will form on line at normal interval and at closed ranks. Platoon commanders are 6 paces in front of and centered on their platoons. The band takes position to the right of and on line with, the honor guard. The colors are posted in the center of the formation, excluding the band, and on line with the honor guard. Commander of the honor guard is 12 paces in front of and centered on the color guard.

→ 5. The band sounds attention upon appearance of the visiting personage, and the honor guard is called to attention. The host welcomes the personage and escorts him/her to a position directly in front of and facing the commander of the honor guard, and takes his/her position to the left of the personage. The distance of this position from that of the commander of the honor guard will depend on local conditions, but it should be sufficient to permit the band and honor guard to pass in review. If sufficient space is not available to permit the march in review, the host will so inform the personage. The commander of the honor guard then executes carry sword, faces about and commands **"Present, ARMS."** and the honor guard goes to present arms. The commander of the honor guard then faces about again and presents sword.

6. As the commander of the honor guard executes present sword, the band plays the appropriate honors. If a gun salute is to be fired, it is begun immediately after the last note of the music. During rendering of honors and the firing of the gun salute, all observers in the vicinity of the honor guard formation stand at attention facing the personage, or if he/she is not in view, toward the honor guard formation. Observers in uniform shall salute during the playing of musical honors and the firing of the gun salute.

7. If a personal flag or a foreign national flag is to be displayed during the visit, it is hoisted at the first note of the music. If a foreign national flag is to be displayed during the gun salute, it is hoisted or unfurled at the sound of the first gun salute and hauled down, or furled, at the sound of the last gun salute. If the personage merits display of the national flag during the gun salute, it is not necessary to display another ensign if one is already flying from the flagstaff of the installation.

8. On completion of musical honors or the gun salute, the commander of the honor guard executes carry sword, faces about and commands **"Order, ARMS,"** and the honor guard goes to order arms. The commander of the honor guard then faces about again, executes present sword, and reports **"Sir/Ma'am, the honor guard is formed."**

Enclosure (1)

9. If the personage desires to inspect the honor guard, the host escorts the personage to a position 3 paces in front of the position of the commander of the honor guard.

a. The commander of the honor guard then executes carry sword, faces about and commands **"PREPARE FOR INSPECTION."**

b. The platoon commanders go to carry sword, face their platoons, and from right to left command **"Open Ranks, MARCH."** The platoon executes open ranks and the platoon commander moves to verify alignment as described in paragraph 9016. After verifying alignment the platoon commander moves to a position 1 pace to the right of and 3 paces in front of the guide, halts, faces down the front rank and commands **"Ready, FRONT"** and **"COVER."** The platoon commander then takes 1 step forward, halts, so that he/she is now 3 paces in front of the guide, faces right and goes to order sword.

c. When all platoons have opened ranks and the platoon commanders are in position 3 paces in front of the guide, facing front, the commander of the honor guard faces about, executes present sword, and reports **"Sir/Ma'am, the honor guard is prepared for your inspection."**

d. The commander of the honor guard then guides the personage, accompanied by the host and others of the official party, through the inspection, remaining at carry sword. The inspection commences at the right front of the band and proceeds along the line of platoons. As the personage halts in front of the platoon commander, the platoon commander executes present sword, and after being personally inspected, goes to carry sword, takes position on the right of the personage, and precedes the personage throughout the inspection of the platoon.

e. The band begins playing as soon as the commander of the honor guard, the personage and the party step off in the direction of the band.

f. Each member of the platoon will execute the movements to inspection arms for their weapon as the personage to be honored approaches, regardless of whether this personage halts and faces him directly or not. If the personage does not halt, and after the last member of the official party has passed the Marine's position, each member of the honor guard will execute port arms and order arms without command.

g. Upon completion of the inspection of the Marine's platoon, the platoon commander, having led the personage down the rear of the last squad executes a column left and halts 3 paces in front of the guide to receive the inspection critique. The platoon commander exchanges salutes with the personage, permits the personage and host to pass in front of the platoon, faces to the left and commands **"Close Ranks, MARCH."** The platoon executes close ranks as described in paragraph 9017 and the platoon commander moves to a position 6 paces in front of, and centered on the platoon, halts, facing front, and goes to order sword.

h. The inspecting party renders salutes as they pass in front of the colors, but not when passing to the rear of the colors.

i. After completing the inspection of the platoon(s), the inspecting party passes around the rear of the formation and the right flank of the band. The commander of the honor guard executes a column left and moves to a position 3 paces in front of the right flank of the band and halts facing front. The personage receiving the honors halts in front of and facing the commander of the honor guard. Salutes are exchanged and the personage, host and other members of the inspecting party step off to their next position to receive the march in

review. When the personage and the party have cleared his/her path, the commander of the honor guard steps off and returns to his/her post halts facing front and goes to order sword.

j. The band stops playing.

10. If the personage does not desire to inspect, but merely to pass around the honor guard, the host, after the commander of the honor guard has reported **"Sir/Ma'am, the honor guard is formed,"** escorts the personage directly toward the right front of the band. The commander of the honor guard executes carry sword, faces to the right as in marching, and proceeds to a point where he/she joins the personage and host, and troops the line.

a. The band begins playing.

b. The order of precedence for the inspecting party, from left to right as they march down the line is: personage, host, and commander of the honor guard.

c. The commander of the honor guard guides the personage along the front of the band, across the front of the honor guard between the front rank and platoon commanders.

d. The inspecting party then passes along the left flank and rear of the honor guard and around the right flank of the band. The commander of the honor guard executes a column left and moves to a position 3 paces in front of the right flank of the band and halts facing front. The personage receiving the honors halts in front of and facing the commander of the honor guard. Salutes are exchanged and the personage, host and other members of the inspecting party step off to their next position to receive the march in review. When the personage and the party have cleared his/her path, the commander of the honor guard steps off and returns to his/her post, halts facing front and goes to order sword.

e. The band stops playing.

11. If the personage desires the honor guard to pass in review only, or to pass in review following an inspection or pass around, he/she will command the commander of the honor guard to **"March the Guard in Review, Sir."**

a. The commander of the honor guard executes carry sword, faces about and commands **"PASS IN REVIEW."** The band then changes direction on the line of march and halts.

b. The commander of the honor guard then commands **"Right, FACE."** The guard executes. The platoon commanders go to carry sword and move to their position at the head of their platoons.

c. The commander of the honor guard then commands **"Right Shoulder, ARMS."** The guard executes. The color guard goes to carry colors executes a right turn and halts.

d. The commander of the honor guard then moves to a position behind the band and at the head of the column of troops formed by the guard.

e. The commander of the honor guard then commands **"Forward, MARCH."** The band and guard step off simultaneously and marches in review. The commander of the honor guard salutes and executes eyes right without command, when 6 paces from the host and visiting personage, and without command terminates the salute and eyes right when 6 paces past the host and visiting personage.



f. Platoon commanders give their platoons the command of **"Eyes, RIGHT"** when 6 paces from the host and visiting personage. Platoon commanders will give their platoons the command of **"Ready, FRONT"** when the last element of the platoon is 6 paces past the host and visiting personage.

→ g. The drum major and the color guard execute eyes right and salute when 6 paces from the host and visiting personage and then execute ready front when 6 paces past the host and visiting personage

h. After the band has passed the position of the host and visiting personage the band executes three column left movements so as to position themselves in front of and facing the host and visiting personage and approximately 12 paces from the left flank of the marching units. The band continues to play and marches from the field following the last marching unit of the honor guard to pass in review.

i. The commander of the honor guard, after passing in review, continues to march down the line of march and leads the honor guard from the field to a designated area and dismisses the guard.

12. If the personage does not desire to have the honor guard pass in review, the commander of the honor guard executes carry sword, faces about and commands **"Present, ARMS."** The honor guard executes present arms. The commander of the honor guard then faces the visiting personage and executes present sword. When the personage returns the salute the commander of the honor guard executes carry sword, faces the honor guard and commands **"Order, ARMS."** The honor guard goes to the order. The commander of the honor guard then faces the visiting personage and goes to order sword. The honor guard remains at attention until the visiting personage has departed. At that time the honor guard is dismissed.

13. The conduct of honor guard ceremonies as outlined above may be modified by commanders when the nature of the ground or exceptional circumstances require such changes.

14. Procedures for the conduct of a joint service honor guard will be as directed by the service commander charged with the conduct of the ceremony.

15. The conduct of honor guard ceremonies at Marine Barracks, Washington, DC. will be conducted as prescribed by the Commandant of the Marine Corps.

#### 22002. RENDERING HONORS TO PERSONAGES DEPARTING AFTER OFFICIAL VISITS ASHORE

1. Honors are rendered upon the departure of a personage entitled to honors in the same manner in which they were rendered upon arrival with the following exceptions:

a. Generally, if the personage inspected the honor guard upon arrival, the host advises him/her that another inspection on departure is not expected.

b. The honor guard will not pass in review.

c. Honors do not commence until the personage has completed their personal farewells.

d. If a gun salute is to be fired, it will begin just prior to the time the personage leaves the area where honors are rendered.

Enclosure (1)

e. If a personal or foreign national flag has been flown during the visit, it will be hauled down upon the last note of musical honors, if no gun salute is fired, or when the last gun is fired.

#### 22003. ESCORTS OF HONOR

1. Escorts of honor are detailed to receive and escort civilian and military persons of high rank. Troops ordered to this duty are selected for their military appearance, bearing and superior discipline.
2. The escort is formed in line opposite the place where the person to be honored is to present himself/herself. The band forms on the flank of the escort in the direction toward which the escort is to march. The escort is brought to attention upon the appearance of the person to be honored. When he/she has taken the position from which he/she will receive the honors, the escort is brought to present arms, and honors due his/her rank are rendered. Upon completion of the honors, the escort is brought to order arms.
3. Ordinarily, the person so honored will, upon completion of the honors, inspect the escort. The escort then forms in column and takes up the march. The honored person with their staff or retinue, take position in the rear of the column. When the personage leaves the escort, the Marine again forms in line; and when he/she has taken position from which to receive them, honors are rendered as upon his/her arrival.
4. When the position of the escort is a considerable distance from the point where the person to be honored is received--where a court yard or wharf intervenes--a double line of sentries, facing inboard, is posted from that point to the escort. These sentries salute as the honored personage passes their individual positions. In this case, an officer is detailed to accompany the honored personage from the place of reception to the escort.

22004. ADDITIONAL HONORS. For prescribed honors due vessels passing close aboard, dignitaries embarked in boats passing close aboard, and ships passing Washington's tomb, see *U.S. Navy Regulations*.

#### 22005. GUN SALUTE

1. Organization
  - a. The number of guns used will be per local SOP.
  - b. The size of the gun crew will be per local SOP.
2. Positioning the Gun for a Salute
  - a. When selecting a position ensure there is no flammable material in front of the gun line.
  - b. Lay all howitzers on line.
  - c. Ensure all personnel are kept a safe distance from the front of the gun line.
  - d. Sight the gun line so that it points away from buildings and the ceremony area.

e. Distance between howitzers will of course be dependent on space provided. However, optimum distance between howitzers is 12 paces.

f. Weapons will be at "center-T" and cradle locking strut removed.

g. Lunette will be in the up position.

### 3. Conduct of the Gun Salute

a. At the proper time the battery gunnery sergeant will march the battery on line 3 paces to the rear of the guns. Individual sections will not march past their respective gun. When the third gun is almost in position the battery gunnery sergeant will give "**Mark Time, MARCH**" and "**Battery, HALT.**" While marking time give the sections enough time to cover between their respective trails before giving "**HALT.**" After giving the battery "**HALT,**" the battery gunnery sergeant will face the battery opposite the direction of fire and receive the report from the section chief. Once the report has been given the battery gunnery sergeant will execute an about face and wait for the officer in charge/noncommissioned officer in charge to center himself/herself and receive the report.

Note: At this time the battery gunnery sergeant should be standing at the actual center of the battery.

b. The officer in charge/noncommissioned officer in charge and the timer will march on in the most direct manner to the battery gunnery sergeant. (Note: The timers position is one pace to the left and 1 pace to the rear of the officer in charge/noncommissioned officer in charge. Use whatever supplementary drill procedures necessary to ensure that is where the Marine is when the officer in charge/noncommissioned officer in charge executes his/her facing movement to receive the report.) After the battery gunnery sergeant reports the battery is formed, the officer in charge/noncommissioned officer in charge commands "**TAKE YOUR POST.**" The battery gunnery sergeant will move 1 pace to the right (opposite the timer) and 1 pace to the rear of the officer in charge/noncommissioned officer in charge. The battery gunnery sergeant will then face in the same direction as the officer in charge/noncommissioned officer in charge. (The direction of fire.) After the officer in charge/noncommissioned officer in charge, timer and battery gunnery sergeant are in place they are commanded as the "**Staff**" ("**Staff, ATTENTION;**" "**Staff, Parade, REST;**" etc.). At this time all commands are coming from the officer in charge/noncommissioned officer in charge.

c. The officer in charge/noncommissioned officer in charge commands "**POST,**" at this time the sections will execute an about face. The officer in charge/noncommissioned officer in charge then commands "**MARCH,**" and all sections will march in the most direct manner to their respective positions. Once the Marines are in place, still facing in the direction of fire, the section chiefs in gun order will command "**Ready, FACE.**" The Marines face inboard.

d. The officer in charge/noncommissioned officer in charge commands "**LOAD**" and the loader will load a round. The breeches will be closed in gun order and the loader then comes back to the position of attention.

(Note: This only occurs on the first round, after that loading will occur as quickly as possible.)

e. If there is a substantial amount of time the officer in charge/noncommissioned officer in charge may give "**Parade, REST.**" When "*Ruffles and Flourishes*" is sounded the crew must be at attention.

f. On the last note of "*Ruffles and Flourishes*" the first round is fired. The timer starts the stopwatch on the first round. For most salutes, rounds must be fired every 5 seconds. That means on every 5-second mark a round must sound. In order for this to happen you must compensate. The officer in charge/non-commissioned officer in charge may either use hand and arm signals to fire each weapon or use verbal commands. (Example: Drop of the arm or "**NUMBER \_\_ FIRE.**") When using the verbal command do not use the traditional "Stand-by Fire" use "**NUMBER \_\_ FIRE.**" Normally the timer must command "**TIME**" every 3 seconds after a round has fired. To make this easy, use every 3, 8, 13, 18, 23, 28, 33, 38, etc., seconds. It is on these seconds the timer would command "**TIME**" to have a round go off at 5, 10, 15, 20, 25, 30, 35, 40, etc., seconds.

g. After firing a round loading is automatic. Loader will keep loading until rounds stop firing. This is in case of a misfire. The procedure for loading is as follows; the section chief will fire the round and open the breech, the loader will catch the sleeve with the right hand give it to the ammo man and at the same time receive a prepared round from the ammo man and load it. The cycle is continuous.

h. It is the responsibility of the battery gunnery sergeant to count each round to ensure the proper amount of rounds is fired. The battery gunnery sergeant will, at a normal tone, count out loud to the officer in charge/noncommissioned officer in charge every round as well as marking them on a piece of paper. After the second to last round the Marine will command to the battery "**LAST ROUND.**"

i. After the last round is fired the officer in charge/noncommissioned officer in charge will command "**Battery, Hand, SALUTE**" or "**Staff, Hand, SALUTE,**" and "**Staff, Ready TWO**" or "**Battery, Ready TWO.**" After the hand salute the officer in charge/noncommissioned officer in charge commands "**UNLOAD.**" All breeches are cleared using the unloading procedure discussed above.

j. After unloading is complete the officer in charge/noncommissioned officer in charge commands "**POST,**" the battery Marines do whatever movement necessary to face opposite the direction of fire. Then the officer in charge/noncommissioned officer in charge commands "**MARCH,**" the battery Marines march back to their original 3 paces behind the gun line.

k. The officer in charge/noncommissioned officer in charge calls the battery gunnery sergeant to "**Center,**" and turns the battery over to the Marine. The officer in charge/noncommissioned officer in charge then faces and leave the area in the most direct manner.

l. Then the battery gunnery sergeant will either dismiss the battery or march them off in the most direct manner.

Note: Sometimes the battery will perform in conjunction with the ceremony and everyone may have to remain in position until the ceremony is over. When the battery is actually part of the ceremony and there is more of the ceremony to be conducted after the gun salute, the officer in charge/noncommissioned officer in charge will wait until the ceremony is concluded to march off.

#### 4. Jams and Misfires

a. If a weapon jams or misfires that weapon is out of action for the rest of the ceremony. The ammo man of that gun will evenly distribute that gun's ammunition smartly and quickly. After the ammunition is distributed the ammo man will return to his/her position on the gun.

b. When a weapon jams or misfires during a ceremony it is now time to fall on your training. When the jam or misfire occurs the section chief will command **"MISFIRE."** As soon as the next section chief hears **"MISFIRE"** the Marine will fire without command. This must be done quickly to make up for any lost time.

22006. HONORS FOR OFFICIAL VISITS OF UNITED STATES OFFICERS (ARTICLE 1035)

Officer	Uniform	Gun Salute		Ruffles and Flourishes	Music	Guard	Side Boys
		Arrival	Departure				
Chairman, Joint Chiefs of Staff	Full Dress	19	19	4	General's or Admiral's March	Full	8
Chief of Staff, U.S. Army	Full Dress	19	19	4	General's March	Full	8
Chief of Naval Operation	Full Dress	19	19	4	Admiral's March	Full	8
Chief of Staff, U.S. Air Force	Full Dress	19	19	4	General's March	Full	8
Commandant of the Marine Corps	Full Dress	19	19	4	Admiral's March	Full	8
Commandant of the Coast Guard	Full Dress	19	19	4	Admiral's March	Full	8
General of the Army	Full Dress	19	19	4	General's March	Full	8
Fleet Admiral	Full Dress	19	19	4	Admiral's March	Full	8
General of the Air Force	Full Dress	19	19	4	General's March	Full	8
Generals	Full Dress	17	17	4	General's March		8
Admirals	Full Dress	17	17	4	Admiral's March	Full	8
Naval or other military governor, commissioned as such by the President within the area of his or her jurisdiction	Full Dress		17	4	General's or Admiral's March	Full	8
Vice Admiral or Lieutenant General	Full Dress		15	3	General's or Admiral's March	Full	8
Rear Admiral or Major General	Full Dress		13	2	General's or Admiral's March	Full	6
Rear Admiral (lower half) or Brigadier General	Full Dress		11	1	General's or Admiral's March	Full	6

Figure 22-1.--Honors Matrix.

MARINE CORPS DRILL AND CEREMONIES MANUAL

PART II: CEREMONIES

CHAPTER 23

MARINE CORPS BIRTHDAY CAKE CUTTING CEREMONY

	<u>PARAGRAPH</u>	<u>PAGE</u>
GENERAL . . . . .	23000	23-3
SEQUENCE OF EVENTS FOR THE MARCH ON . . . . .	23001	23-3
READING THE MESSAGES AND CUTTING THE CAKE . . . . .	23002	23-10
SEQUENCE OF EVENTS FOR THE MARCH OFF AND CONCLUSION OF THE CEREMONY . . . . .	23003	23-12
VARIATIONS . . . . .	23004	23-15
RECOMMENDED PERSONNEL ASSIGNMENTS . . . . .	23005	23-16

FIGURE

23-1	PARTICIPANTS STAGED . . . . .	23-3
23-2	MUSIC'S MOVEMENTS . . . . .	23-4
23-3	ADJUTANT, DRUMMERS AND TRUMPETERS MOVEMENTS . . . . .	23-5
23-4	MARCH ON OF GENERAL OFFICERS AND ESCORTS . . . . .	23-6
23-5	MOVEMENTS OF THE COMMANDING GENERAL (OR COMMANDING OFFICER) AND GUEST OF HONOR . . . . .	23-7
23-6	MOVEMENTS OF THE COLOR GUARD . . . . .	23-9
23-7	MOVEMENTS OF THE CAKE . . . . .	23-10
23-8	MOVING THE CAKE IN ORDER TO CLEAR THE LINE OF MARCH . . . . .	23-13
23-9	MARCH OFF OF COLOR GUARD, COMMANDING GENERAL, GUEST OF HONOR AND GENERAL OFFICERS . . . . .	23-13
23-10	MOVEMENTS OF THE ESCORTS DURING THE MARCH OFF . . . . .	23-14
23-11	MOVEMENTS OF THE DRUMMERS AND TRUMPETERS DURING THE MARCH OFF . . . . .	23-15



PART II: CEREMONIES

CHAPTER 23

MARINE CORPS BIRTHDAY CAKE CUTTING CEREMONY

23000. GENERAL. The following procedure is prescribed as a guide for the conduct of the Marine Corps Birthday Cake Cutting Ceremony. It is outlined on the basis of a Marine Corps post commanded by a general officer. At post where no general officer is present, and a staff noncommissioned officer, enlisted or unit balls, modifications may be made as necessary to meet local conditions. Rehearsals must be conducted to ensure that the ceremony proceeds smoothly and precisely.

23001. SEQUENCE OF EVENTS FOR THE MARCH ON

1. H-Hour-15 Minutes. All participants in the ceremony are formed at the entrance to the ballroom. (See figure 23-1.) All bars, if any, will close.

CEREMONY LOCATION

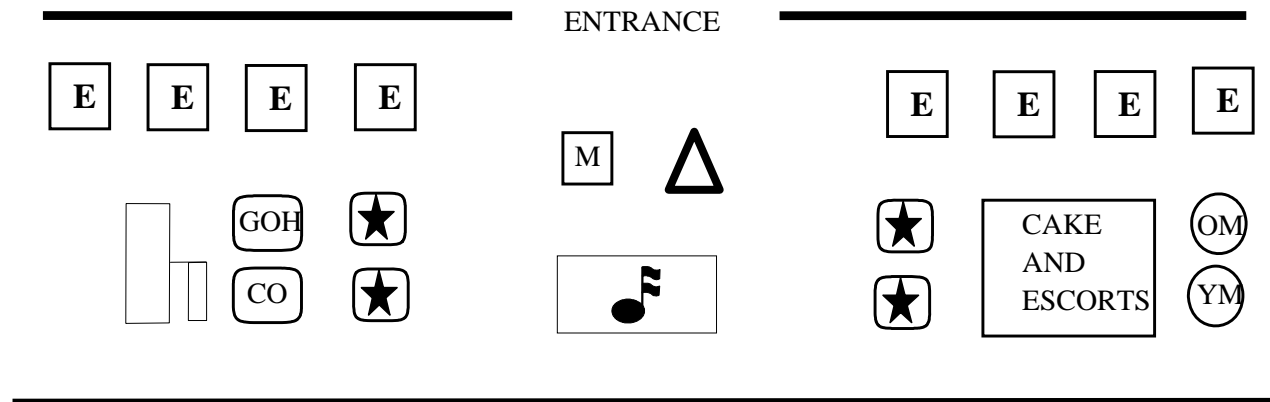

LEGEND

- |                  |                    |                              |
|------------------|--------------------|------------------------------|
| = ESCORT         | = GENERAL OFFICER  | = ADJUTANT                   |
| = GUEST OF HONOR | = OLDEST MARINE    | = DRUM & TRUMPET<br>DETAIL ← |
| = CO/CG          | = YOUNGEST MARINE  | = MUSIC                      |
|                  | = NARRATOR/LECTURN | = COLOR GUARD                |

→ Figure 23-1.--Participants Staged.

Enclosure (1)



2. H-Hour-5 Minutes

- a. Bugler moves to position centered on the dance floor and sounds "Attention," followed by "Officers Call" (or "First Sergeant's Call" at staff noncommissioned officer/enlisted balls) and then departs the floor and returns to a position with the drummers and trumpeters. (See figure 23-2.)
- b. The escorts draw swords and go to parade rest.

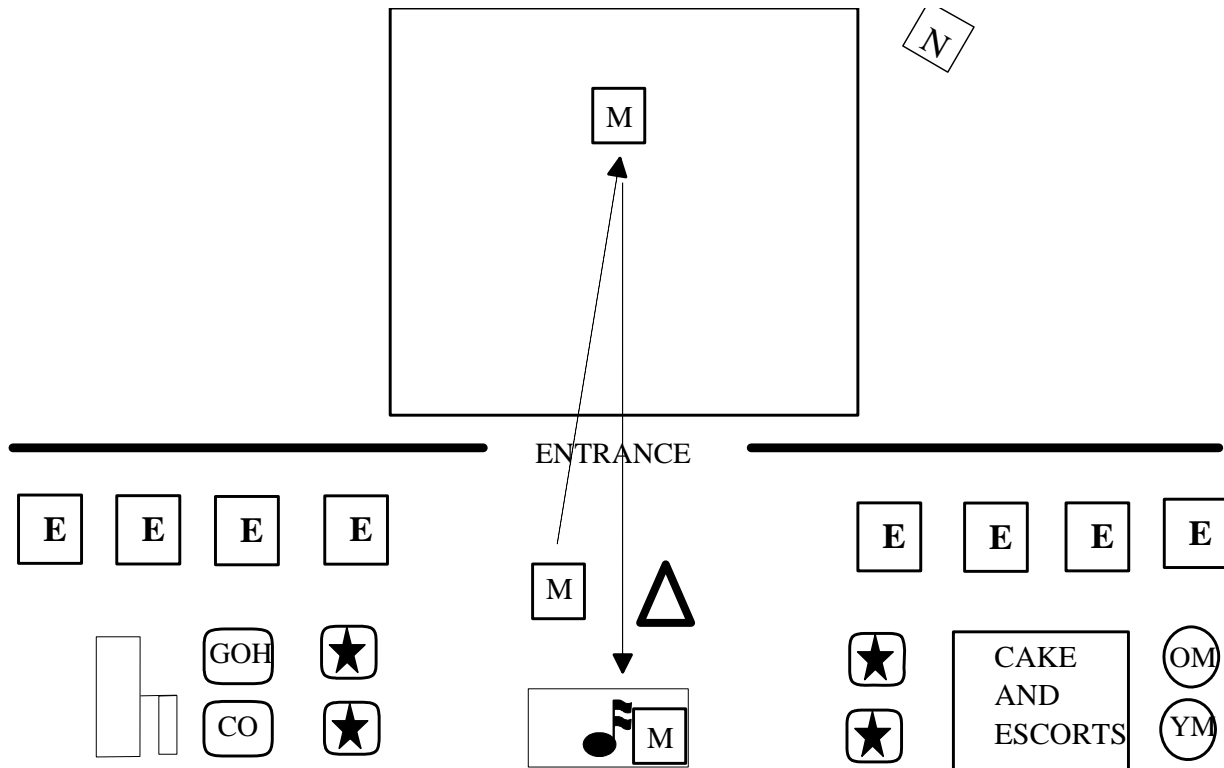

Figure 23-2.--Music's Movements.

**NARRATOR:** "GOOD EVENING LADIES AND GENTLEMEN, WELCOME TO THE UNITS NAME BALL CELEBRATING THE # OF BIRTHDAY (e.g., 221ST) BIRTHDAY OF OUR CORPS. (INVOCATION OPTIONAL) PLEASE RISE AS NAME OF CHAPLAIN DELIVERS THE INVOCATION." Chaplain delivers the invocation.

**NARRATOR:** "LADIES AND GENTLEMEN PLEASE BE SEATED AS THE CEREMONY IS ABOUT TO BEGIN."

3. H-Hour. The adjutant moves to a position at the far end of the dance floor from the entrance, halts faces the entrance, and draws sword. (See figure 23-3.)

- 4. Adjutant commands "SOUND ATTENTION." Drum and trumpet detail sounds "Attention." Escorts execute attention without command.
- 5. Adjutant commands "SOUND ADJUTANT'S CALL." Drum and trumpet detail sounds "Adjutant's Call."

Enclosure (1)

- a. Immediately after "Adjutants Call" the drum and trumpet detail plays "French Foreign Legion." Drum and trumpet detail marches down a cleared lane to the far end of the dance floor, countermarches in front of the adjutant, and followed by the adjutant, marches back to the main entrance, countermarches again, and halts. Drum and trumpet detail then moves sufficient distance left or right to clear the entrance doorway.
- Note: If the ballroom is too small for the drum and trumpet detail to remain on the dance floor, or if they are part of the main band, then they would march off the dance floor.
- b. The adjutant moves to a position behind the cake. The march is ceased on command of the drum major. (See figure 23-3.)

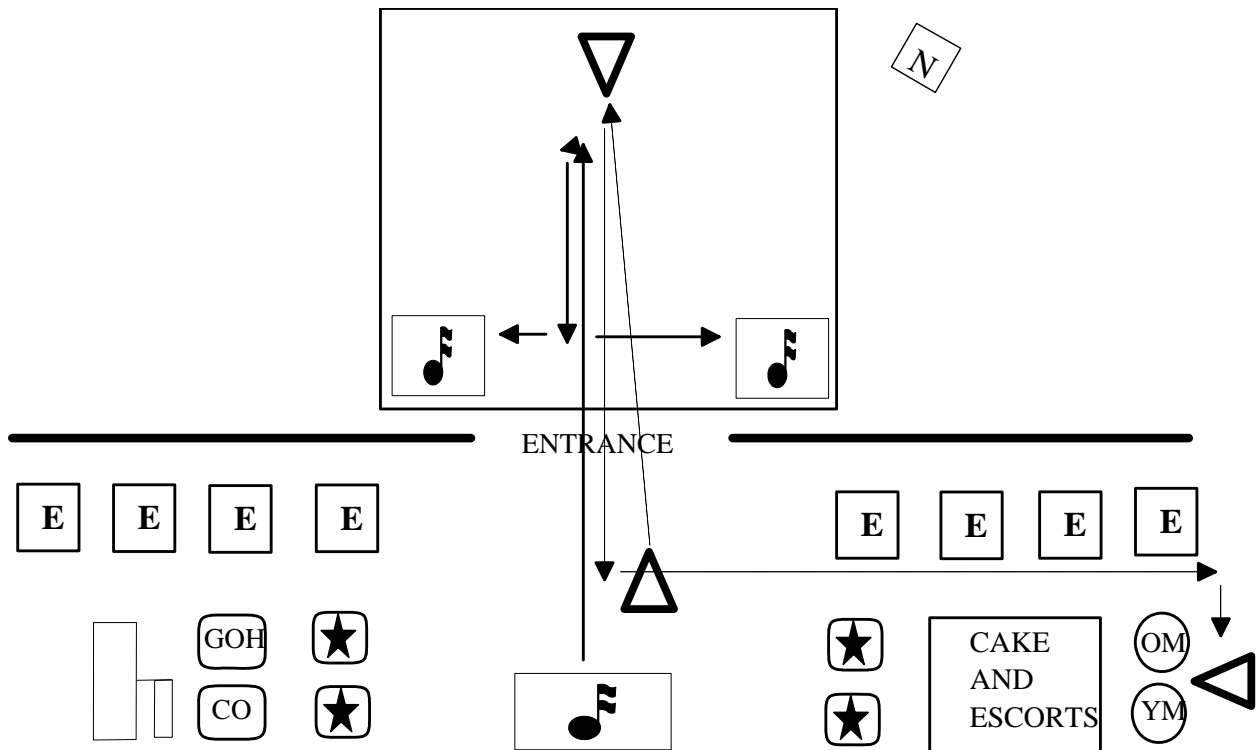

Figure 23-3.--Adjutant, Drummers and Trumpeters Movements.

6. Senior escort commands "**Forward, MARCH.**"

- a. Band commences playing "*Semper Fidelis.*"
- b. The two senior escorts (1st pair) enter the ball room together and march to their position at the far end of the dance floor, halt, face outboard, march forward to their position (4-8 paces) halt, face about and go to order swords.
- c. The remainder of the escorts step off by twos (2nd pair, 3d pair, etc.) from senior to junior, at 4-pace intervals and move to their position on the

Enclosure (1)

dance floor in the same manner as the lead escorts, the two lines forming the two long sides of a hollow rectangle. (See paragraph 23005 for the recommended composition of escorts.)

d. Once all escorts are in position and at order sword, general officers, if present, enter the ball room in pairs from the main entrance, march down the line of escorts to their position at the far end of the dance floor, halt and face the entrance thus forming the third side of the rectangle.

e. Two spaces are left open in the center of the line of general officers. When all are in position the band stops playing. (See figure 23-4.)

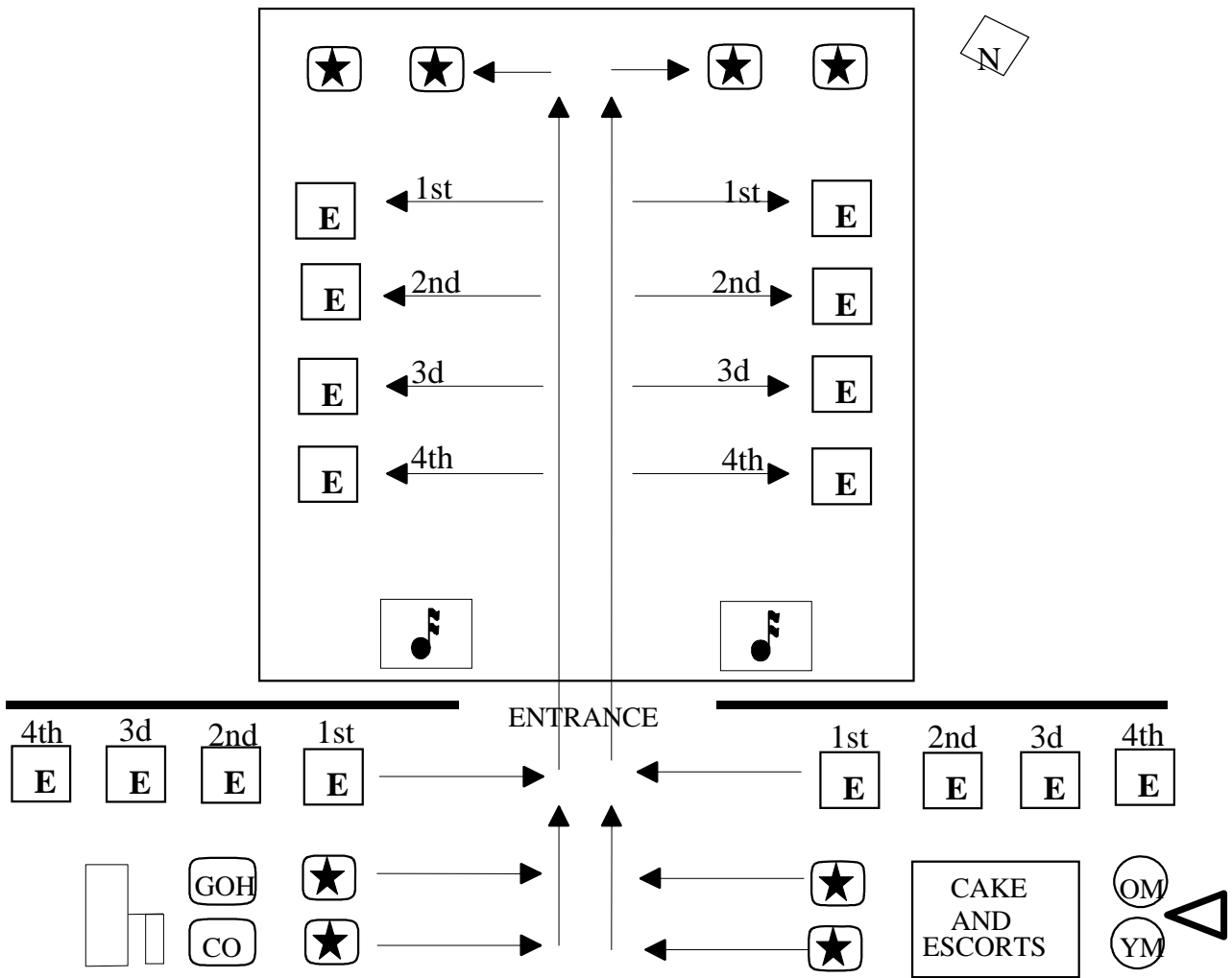

Figure 23-4.--March on of General Officers and Escorts.

→ f. Band sounds "Attention." The commanding general (see note) and the guest of honor enter the ballroom together and move to a position centered between the line of escorts and halt. (See figure 23-5.)

Enclosure (1)

**NARRATOR: "LADIES AND GENTLEMEN PLEASE RISE FOR HONORS TO THE COMMANDING GENERAL (GUEST OF HONOR AND COMMANDING OFFICER) AND REMAIN STANDING FOR THE MARCH ON OF THE COLORS, THE "NATIONAL ANTHEM" AND THE ENTRY OF THE TRADITIONAL BIRTHDAY CAKE."**

Note: At a ball where neither the guest of honor nor the escort rate musical honors then the narrator makes the above statement but no musical honors are rendered. The escorts simply **"Present, ARMS."** In this case the line of general officers would be omitted.)

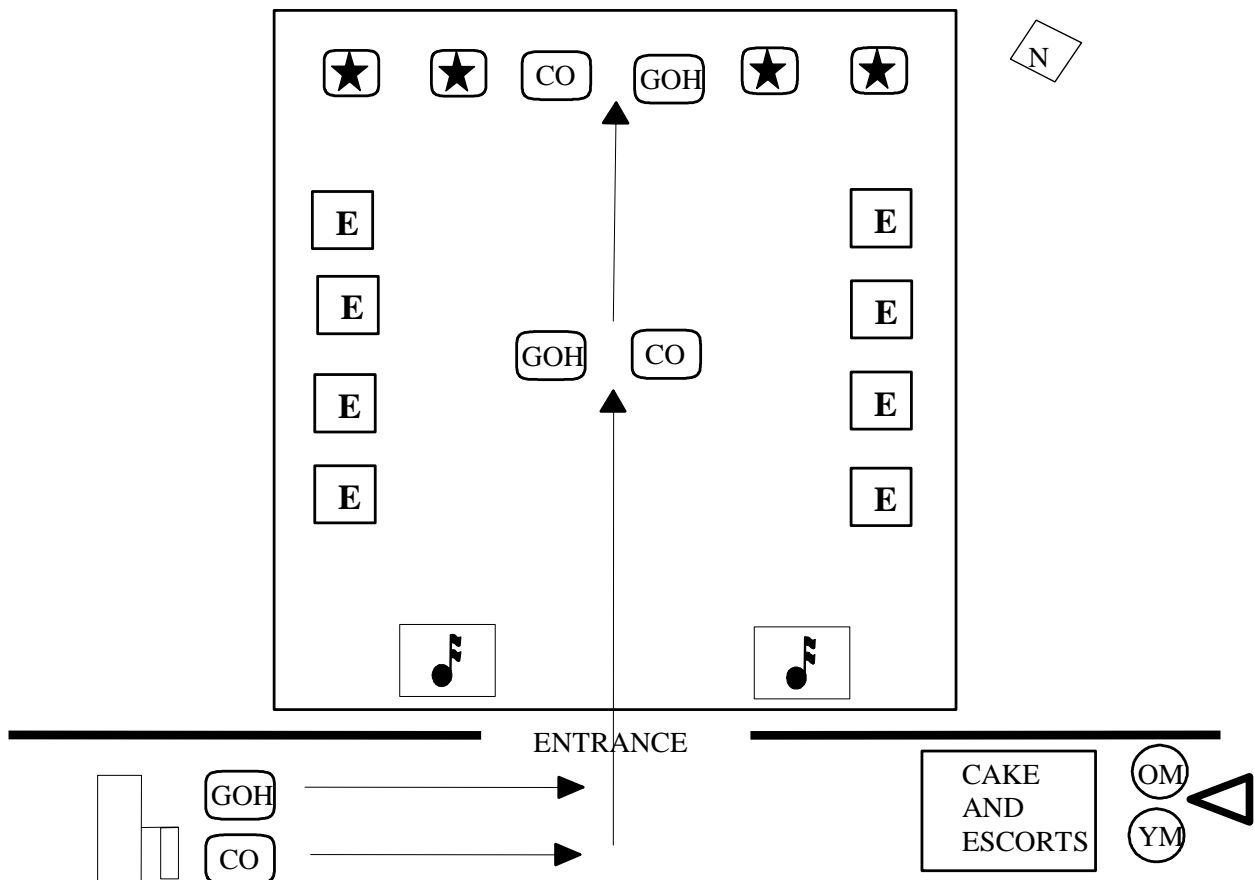

Figure 23-5.--Movements of the Commanding General (or Commanding Officer) and Guest of Honor.

7. The senior escort commands **"Present, SWORD."** The escorts execute present sword. The band plays appropriate musical honors. The commanding general (or commanding officer) and the guest of honor return the salute if covered. After the last note of honors the commanding general (or commanding officer) and guest of honor terminate their salute.

8. The senior escort commands **"Order, SWORD."** The escorts execute order sword. The commanding general (or commanding officer) and guest of honor move to their positions in the line of general officers, halt and face about. (See figure 23-5.) When both are in position.

- 9. Band sounds "*Attention.*" The color guard enters the ballroom at the carry and marches to a point halfway down the line of escorts, halts and remains at the carry (see figure 23-6).
10. The senior escort commands "**Present, SWORD.**" The escorts present sword.
- a. Commanding general (or commanding officer), guest of honor and general officers, if covered, salute on the first note of the music.
- b. The color guard riflemen execute present arms from the carry on the command of present sword by the senior escort. The band then plays the "*National Anthem.*" The organizational colors presents on the first note of the music and returns to the carry on the last note.
- c. Commanding general (or commanding officer), guest of honor and general officers, if covered, cut their salute on the last note of the music.
11. The senior escort commands "**Order, SWORD.**" The escorts order sword.
- a. The color guard riflemen return to the carry. The color guard then marches forward to the far end of the dance floor, countermarches and marches back down the line of escorts to their position by the main entrance, countermarches, halts and goes to the order. The color guard then separates by executing sufficient left and right steps for the cake and escorts to enter the ballroom. (See figure 23-6.) Once the color guard is in position.
- b. Band sounds "*Attention.*"
- c. The band then plays the "*Marines Hymn*" (slow version) and the cake escorts (see paragraph 23005.3 for the recommended composition of the cake escorts) enter the ballroom. Between them they push a serving cart on which are placed the birthday cake, a Marine sword (officer or noncommissioned officer), two plates, three forks and napkins. The oldest and youngest Marine present, and adjutant follow the cake. The escorts slowly roll the cake to a position in front of the commanding general (or commanding officer), halt, take one side step and face inboard toward the cake. (See figure 23-7.) The band stops playing.

**NARRATOR: "LADIES AND GENTLEMEN PLEASE BE SEATED."**

Enclosure (1)

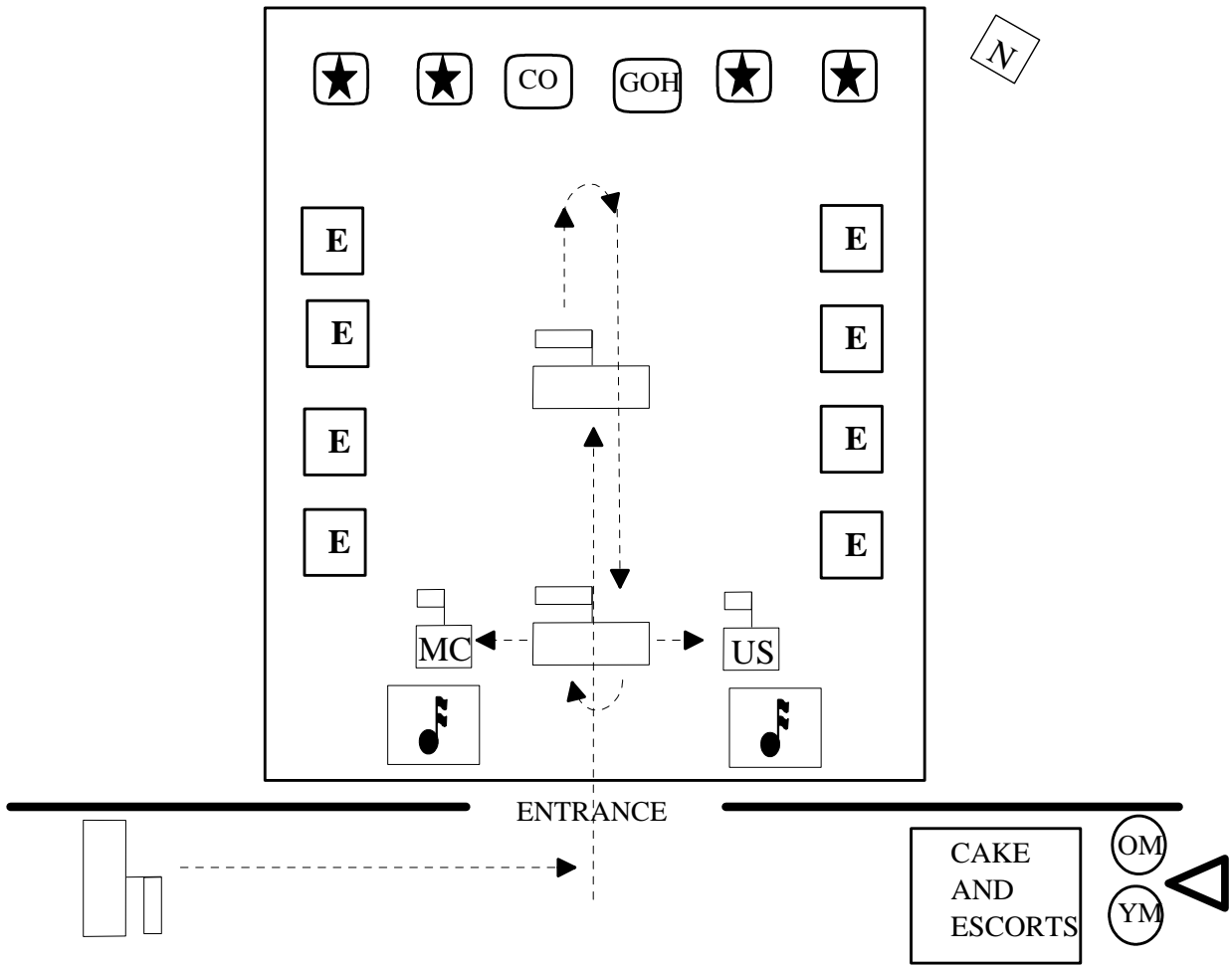

Figure 23-6.--Movements of the Color Guard.

12. The senior escort commands **"Parade, REST."** All escorts, cake escorts, color guard, band, general officers and guest of honor execute.

a. The adjutant remains at attention, faces about goes to order sword, and moves the sword into the position for reading documents described in chapter 5. The adjutant carries the scroll under the left arm in the same manner as a cased sword would be carried.

b. The adjutant then unfurls the scroll containing General Lejeune's Message and prepares to read it after the narrator has read the introductory statement.

Note: In particularly large formations or facilities where the adjutant may be hard to hear and/or a wireless microphone is not available, the narrator may read General Lejeune's Message. In that case the adjutant would remain at carry sword during the reading of the message.

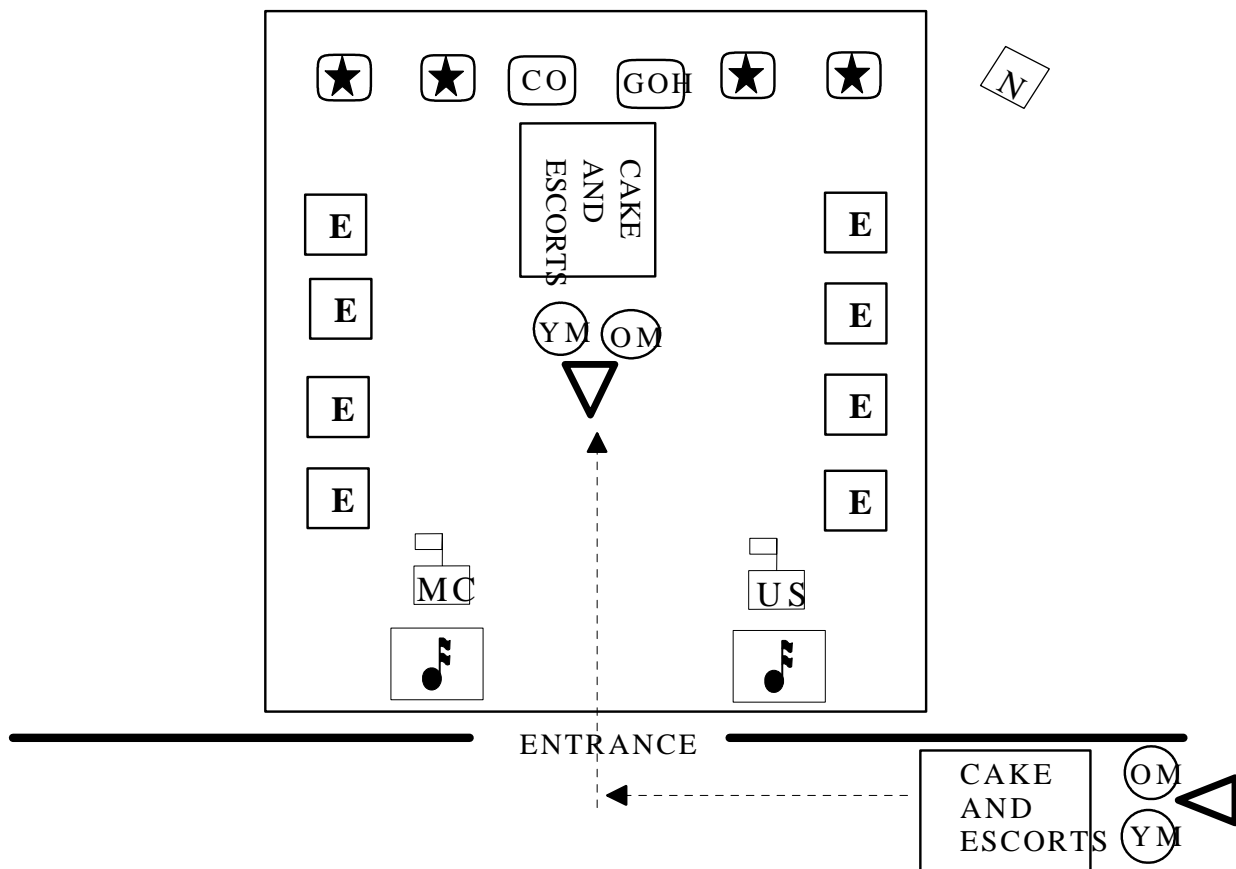

Figure 23-7.--Movements of the Cake.

23002. READING THE MESSAGES AND CUTTING THE CAKE

1. The narrator begins this portion of the ceremony by reading the introductory statement to General Lejeune's traditional birthday message.

**NARRATOR:** "ON NOVEMBER 1ST, 1921, JOHN A. LEJEUNE, 13TH COMMANDANT OF THE MARINE CORPS, DIRECTED THAT A REMINDER OF THE HONORABLE SERVICE OF THE CORPS BE PUBLISHED BY EVERY COMMAND, TO ALL MARINES THROUGHOUT THE GLOBE, ON THE BIRTHDAY OF THE CORPS. SINCE THAT DAY, MARINES HAVE CONTINUED TO DISTINGUISH THEMSELVES ON MANY BATTLEFIELDS AND FOREIGN SHORES, IN WAR AND PEACE. ON THIS BIRTHDAY OF THE CORPS, THEREFORE, IN COMPLIANCE WITH THE WILL OF THE 13TH COMMANDANT, ARTICLE 38, UNITED STATES MARINE CORPS MANUAL, EDITION OF 1921, IS REPUBLISHED AS FOLLOWS:

**ADJUTANT/NARRATOR:** ON NOVEMBER 10TH, 1775, A CORPS OF MARINES WAS CREATED BY A RESOLUTION OF THE CONTINENTAL CONGRESS. SINCE THAT DATE MANY THOUSAND MEN HAVE BORE THE NAME MARINE. IN MEMORY OF THEM IT IS FITTING THAT WE WHO ARE MARINES SHOULD COMMEMORATE THE BIRTHDAY OF OUR CORPS BY CALLING TO MIND THE GLORY OF ITS LONG AND ILLUSTRIOUS HISTORY.

THE RECORD OF OUR CORPS IS ONE WHICH WILL BEAR COMPARISON WITH THAT OF THE MOST FAMOUS MILITARY ORGANIZATIONS IN THE WORLD'S HISTORY. DURING 90 OF THE FIRST

146 YEARS OF ITS EXISTENCE, THE MARINE CORPS HAS BEEN IN ACTION AGAINST THE NATION'S FOES. FROM THE BATTLE OF TRENTON TO THE ARGONNE, MARINES HAVE WON FOREMOST HONORS IN WAR, AND IN THE LONG ERAS OF TRANQUILLITY AT HOME. GENERATION AFTER GENERATION OF MARINES HAVE GROWN GRAY IN WAR, IN BOTH HEMISPHERES, AND IN EVERY CORNER OF THE SEVEN SEAS, THAT OUR COUNTRY, AND ITS CITIZENS MIGHT ENJOY PEACE AND SECURITY.

IN EVERY BATTLE AND SKIRMISH SINCE THE BIRTH OF OUR CORPS, MARINES HAVE ACQUITTED THEMSELVES WITH THE GREATEST DISTINCTION, WINNING NEW HONORS ON EACH OCCASION UNTIL THE TERM MARINE HAS COME TO SIGNIFY ALL THAT IS HIGHEST IN MILITARY EFFICIENCY AND SOLDIERLY VIRTUE.

THIS HIGH NAME OF DISTINCTION AND SOLDIERLY REPUTE, WE WHO ARE MARINES TODAY, HAVE RECEIVED FROM THOSE WHO HAVE PROCEEDED US IN THE CORPS. WITH IT WE ALSO RECEIVED FROM THEM THE ETERNAL SPIRIT WHICH HAS ANIMATED OUR CORPS FROM GENERATION TO GENERATION AND HAS BEEN THE DISTINGUISHING MARK OF MARINES IN EVERY AGE. SO LONG AS THE SPIRIT CONTINUES TO FLOURISH, MARINES WILL BE FOUND EQUAL TO EVERY EMERGENCY IN THE FUTURE AS THEY HAVE BEEN IN THE PAST, AND THE MEN OF OUR NATION WILL REGARD US AS WORTHY SUCCESSORS TO THE LONG LINE OF ILLUSTRIOUS MEN WHO HAVE SERVED AS "SOLDIERS OF THE SEA" SINCE THE FOUNDING OF THE CORPS."

2. The adjutant, without command, then puts away the scroll, returns to carry sword and exits the ballroom. Once clear of the ballroom the adjutant returns sword, this completes his/her portion of the ceremony.

**NARRATOR:** "THE INSPIRING MESSAGE OF OUR 13TH COMMANDANT HAS LEFT ITS MARK IN THE HEARTS AND MINDS OF ALL MARINES." The narrator would now read the current Commandant's birthday message.

**NARRATOR:** "LADIES AND GENTLEMEN A MESSAGE FROM THE COMMANDANT OF THE MARINE CORPS." (text inserted here)

Note: At this time the narrator may introduce the commanding general (or commanding officer)/guest of honor for their remarks. However, remarks may be deferred until after the cake is cut in which case skip to paragraph 23002.5.

**NARRATOR:** "LADIES AND GENTLEMEN, THE COMMANDING GENERAL (Name and title)."

3. The commanding general makes a few brief remarks and introduces the guest of honor, who makes appropriate remarks concerning the significance of the birthday, etc., remarks should be brief and to the point.

4. After the messages are read and remarks have been completed the commanding general and guest of honor move to the cake.

5. The oldest and youngest Marine move to position on the side of the cake nearest to the commanding general. As the commanding general approaches the cake the senior cake escort steps forward, takes the sword from the cake cart and delivers it to the commanding general by passing it over the left forearm, grip toward the commanding general. (See paragraph 5017.)

6. As the commanding general cuts the cake the band begins playing "Auld Lang Syne."



7. Assistance is rendered by the cake escorts in placing the pieces on the plate.
8. The first piece is given to the guest of honor who takes a bite and returns the plate to the cake escort.
9. The second piece is placed on a plate with two forks and given to the oldest Marine who takes a bite and passes the piece to the youngest Marine who takes a bite. The youngest Marine then returns the plate to a cake escort who places it back on the serving cart.
10. While the cake is being cut and presented the narrator reads:

**NARRATOR: "LADIES AND GENTLEMEN, IT IS CUSTOMARY AT MARINE CORPS BIRTHDAY CELEBRATIONS WORLDWIDE FOR MARINES TO CUT A TRADITIONAL CAKE IN CELEBRATION OF THE BIRTH OF OUR ILLUSTRIOUS CORPS. THE FIRST PIECE IS GIVEN TO THE GUEST OF HONOR, NAME AND TITLE. THE NEXT PIECE IS GIVEN TO THE OLDEST AND YOUNGEST MARINES PRESENT, SYMBOLIZING THE EXPERIENCE AND THE YOUTHFUL SPIRIT THAT ARE HALLMARKS OF OUR CORPS. THE OLDEST MARINE PRESENT IS GRADE AND NAME. HE WAS BORN ON DATE IN CITY, STATE. HE WAS COMMISSIONED/ENLISTED IN THE MARINE CORPS ON DATE AND IS CURRENTLY ASSIGNED TO UNIT AND DUTIES. THE PASSING OF THE CAKE FROM THE OLDEST TO THE YOUNGEST MARINE SYMBOLIZES THE PASSING OF HISTORY AND TRADITIONS TO THE NEXT GENERATION. THE YOUNGEST MARINE PRESENT IS GRADE AND NAME. HE WAS BORN ON DATE IN CITY, STATE. HE WAS COMMISSIONED/ENLISTED IN THE MARINE CORPS ON DATE AND IS CURRENTLY ASSIGNED TO UNIT AND DUTIES."**

11. After the youngest Marine has tasted and returned the cake, the commanding general, guest of honor, oldest Marine and youngest Marine return to their positions.

Note: If the commanding general (or commanding officer)/guest of honor did not make remarks before the cake was cut the narrator would introduce them at this time.

**NARRATOR: "LADIES AND GENTLEMEN, THE COMMANDING GENERAL (name and title)."** The commanding general makes a few brief remarks and introduces the guest of honor, who makes appropriate remarks concerning the significance of the birthday, etc., remarks should be brief and to the point.

#### 23003. SEQUENCE OF EVENTS FOR THE MARCH OFF AND CONCLUSION OF THE CEREMONY

1. The march off is begun by moving the cake from in front of the line of general officer to a position out of the line of march. Once the oldest and youngest Marines are in position, the cake escorts take one-step forward face left or right and re-grasp the cake cart. The senior cake escort then quietly commands the cake escorts, oldest and youngest Marines to "**Forward, MARCH,**" and moves the cake detail from the dance floor in order to clear the way for the march off. (See figure 23-8.) The cake escorts, and oldest and youngest Marines then face towards the entranceway and remain in position.
2. The senior escort commands, "**Detail, ATTENTION.**" Detail executes. The color guard begins the march off by side stepping back to close interval and going to carry colors. (See figure 23-9.)

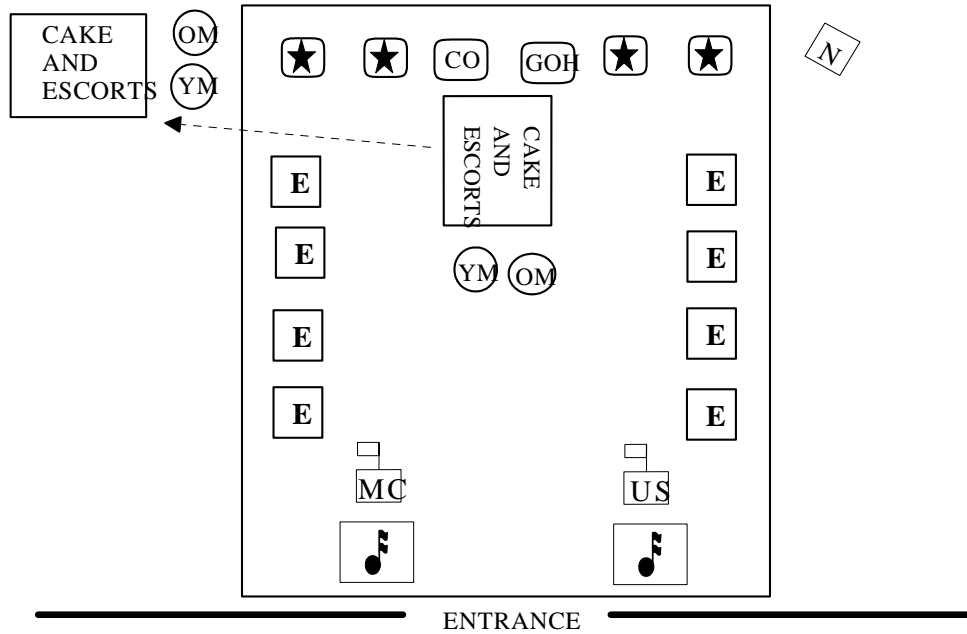

Figure 23-8.--Moving the Cake in Order to Clear the Line of March.

**NARRATOR: "LADIES AND GENTLEMEN PLEASE RISE FOR THE RETIRING OF THE COLORS AND THE MARCH OFF OF THE OFFICIAL PARTY."**

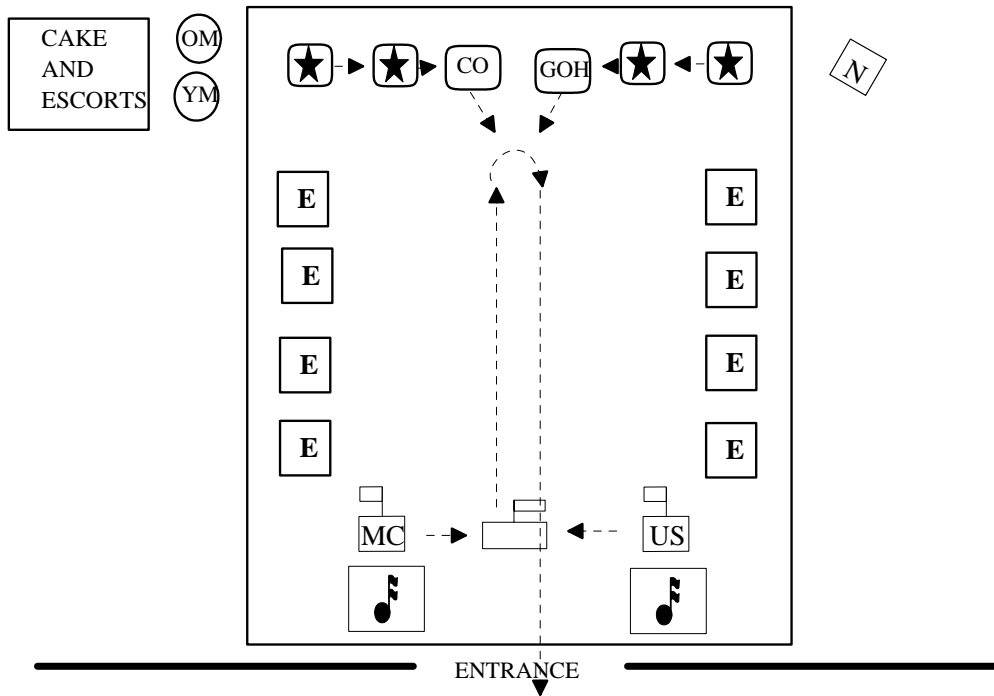

Figure 23-9.--March Off of Color Guard, Commanding General, Guest of Honor and General Officers.

3. The senior escort commands "**Present, SWORD.**" The escorts execute.
4. The color sergeant commands "**Forward, MARCH.**"
  - a. The band begins playing "*Semper Fidelis.*"
  - b. The color guard marches forward down the line of escorts to the far end of the dance floor, countermarches, marches back down the line of escorts and from the room. (See figure 23-9.)
  - c. When the colors have cleared the room the commanding general and guest of honor march down the line of escorts and from the room. When they have cleared the room they are followed in a similar manner by the remainder of the general officers, who march from the room in pairs until the last one has cleared the room. (See figure 23-9.)
5. The senior escort commands "**Carry, SWORD.**" The escorts execute.
  - a. The two senior escorts (1st pair) march forward to the centerline of the floor, halt, face the main entrance and march from the ballroom. (See figure 23-10.)
  - b. As each successive pair (2nd pair, 3rd pair, etc.) of escorts is uncovered by the preceding escorts, they march forward to the centerline of the dance floor, halt, face the main entrance and march from the ballroom. (See figure 23-10.)

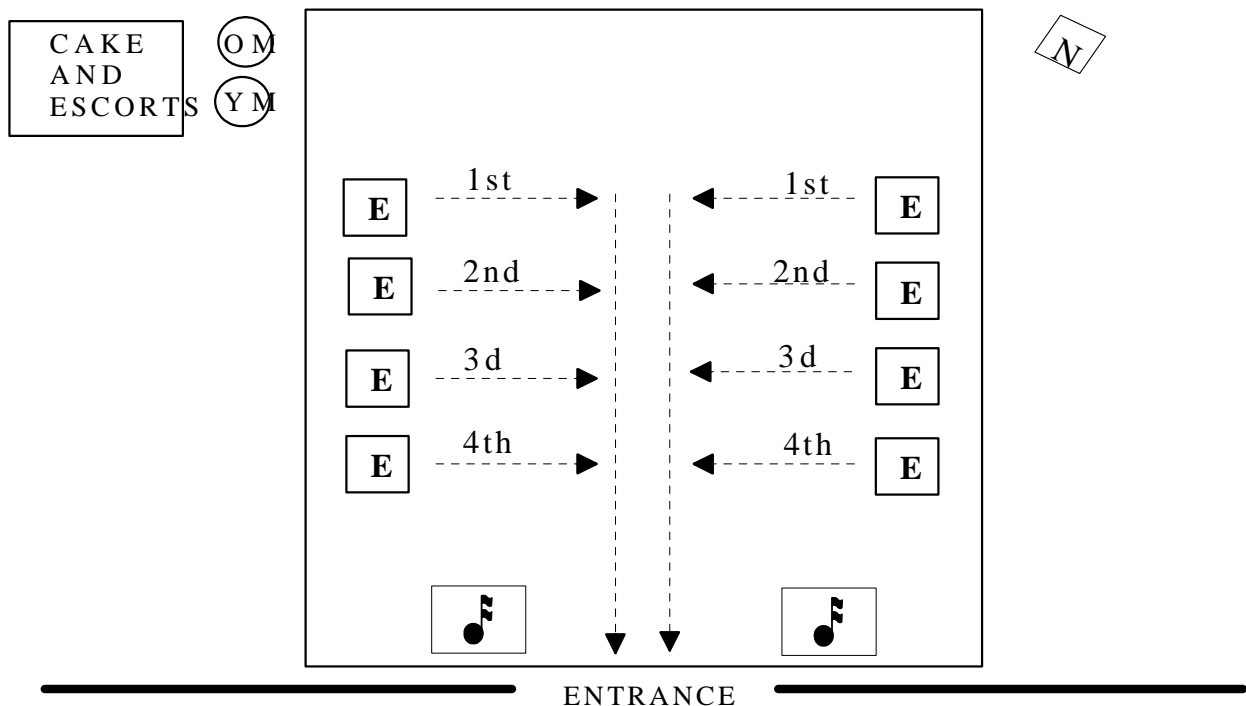

Figure 23-10.--Movements of the Escorts During the March Off.

c. After the last pair of escorts clear the room the band plays "Anchors Away" and "Marines Hymn."

Note: If the drummers and trumpeters marched out of the ballroom at the beginning of the ceremony then delete the next step.)

d. The drummers and trumpeters close by side-stepping to the right and left, take up the beat, march the length of the dance floor, countermarch, and march back down the floor and out of the entrance way. (See figure 23-11.)

e. As the last trumpeter clears the entranceway, the doors are closed, thus concluding the ceremony.

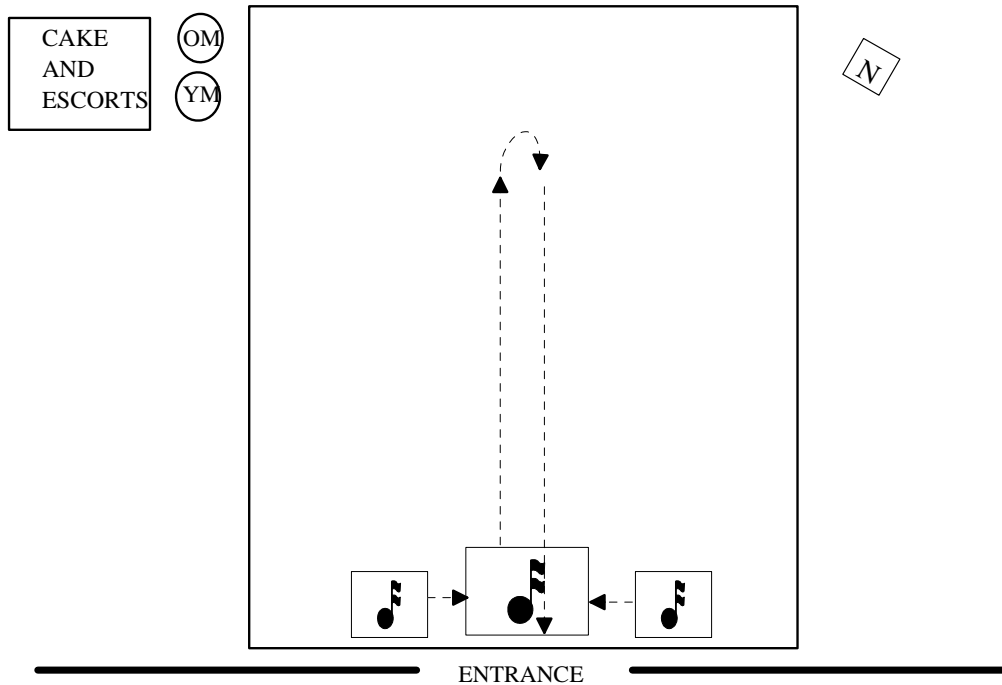

Figure 23-11.--Movements of the Drummers and Trumpeters During the March Off.

**NARRATOR: "LADIES AND GENTLEMEN THAT CONCLUDES OUR CEREMONY. PLEASE ENJOY YOUR EVENING. THANK YOU."**

Note: In the case where no general officer is in attendance substitute one of the following for the term "commanding general."

Unit/Officer's Ball	"Commanding Officer"
SNCO Ball	The rank of the senior enlisted present
Enlisted Ball	"Ball Committee Chairman"

→ 23004. VARIATIONS. It is recognized that considerable variation must be made in this ceremony to conform to the configuration of the dance floor or the absence of a band. Examples are:

Enclosure (1)

1. When the ceremony is conducted at posts where there is no general officer commanding, the senior line officer will follow the procedure outlined above for the commanding general. At such posts the escorts will be formed from the appropriate ranks present and the line of general officers will be deleted.
2. When the ceremony is conducted at noncommissioned officers or other enlisted messes, appropriate ranking noncommissioned officers will preside and form the escort.
3. Where the ballroom is of sufficient size, two officers or enlisted Marines of each rank will be assigned to the escort.
4. Where practicable, the Blue Dress "A," "B" or Service "A" will be worn by those officers and Marines participating in the ceremony.
5. Officers and noncommissioned officers participating in the ceremony should be armed with swords; however, at no time will Marines in the grade of LCpl through Pvt be armed with a sword. If the ceremony is conducted in utilities because of field duty, deployment, etc., the sword will not be worn.
6. The birthday cake will be mounted on a mess serving cart or similar conveyance covered with scarlet and gold bunting.
7. Where swords are not available, escorts will execute a hand salute whenever the command of "**Present, ARMS**" is given.
8. Guests may be cleared from the center of the ballroom by stretching white lines, supported by second lieutenants or noncommissioned officer, moving from the center line of the dance floor toward either side to provide required space for the ceremony.

#### 23005. RECOMMENDED PERSONNEL ASSIGNMENTS

1. The number of officers and Marines assigned to be escorts will depend on the number of personnel available to the command and the space available to conduct the ceremony. The following are some examples of the composition of the escorts.

<u>OFFICERS BALL</u>				<u>STAFF NONCOMMISSIONED OFFICERS BALL</u>			
<u>Option A</u>		<u>Option B</u>		<u>Option A</u>		<u>Option B</u>	
Col	Col	Col	LtCol	SgtMaj	SgtMaj	SgtMaj	MGySgt
LtCol	LtCol	Maj	Capt	MGySgt	MGySgt	1stSgt	MSgt
Maj	Maj	1stLt	2ndLt	1stSgt	1stSgt	GySgt	SSgt
Capt	Capt	CWO	CWO	MSgt	MSgt		
1stLt	1stLt			GySgt	GySgt		
2ndLt	2ndLt			SSgt	SSgt		
CWO5	CWO5						
CWO4	CWO4						
CWO3	CWO3						
CWO2	CWO2						
WO1	WO1						

UNIT/ALL RANKS BALL

Col	LtCol
Maj	Capt
1stLt	2ndLt
CWO	CWO
SgtMaj	MGySgt
1stSgt	MSgt
GySgt	SSgt
Sgt	Cpl
LCpl*	PFC*
Pvt*	Pvt*

ENLISTED BALL

Sgt	Sgt
Cpl	Cpl
LCpl*	LCpl*
PFC*	PFC*

2. The adjutant should be assigned as follows:

BALL

Officers or all ranks  
Staff Noncommissioned Officer  
Enlisted

ADJUTANT ASSIGNED

Major or Captain  
Gunnery Sergeant or Staff Sergeant  
Sergeant or Corporal

3. Cake escorts should be assigned as follows:

Officers Ball

2ndLt	2ndLt
WO1	WO1

SNCO Ball

GySgt	GySgt
SSgt	SSgt

Enlisted Ball

PFC	PFC
Pvt*	Pvt*

Unit/All Hands Ball

2ndLt	SSgt
WO1	Pvt*

\*Marines in the grades of LCpl, PFC, and Pvt are never armed with a sword.

MARINE CORPS DRILL AND CEREMONIES MANUAL

PART II: CEREMONIES

CHAPTER 24

MESS NIGHT

	<u>PARAGRAPH</u>	<u>PAGE</u>
GENERAL . . . . .	24000	24-3
SCHEDULE OF EVENTS . . . . .	24001	24-3
SEQUENCE . . . . .	24002	24-4





PART II: CEREMONIES

CHAPTER 24

MESS NIGHT

24000. GENERAL

1. It has long been an established custom of the officers and/or noncommissioned officers of a military organization to dine together periodically. A mess night is a formal dinner in mess by all members, or by the officers and noncommissioned officers of a particular post or unit. It is sometimes called a "Guest Night" or a "Dining-in" and less commonly as a "Formal Mess Dinner" or "Band Night." The mess night is a formal stag dinner where spouses and dates do not attend. The object of a mess night may vary from a wish to foster good comradeship among fellow Marines, to celebrate the anniversary of significant events in a units history, to "dine-out" members being detached, or to honor guests from another unit, service or country.

2. The procedures for a mess night outlined in this Chapter are to be used as a guide. Commanders may modify these procedures to accommodate local requirements and restrictions. In addition to the information contained in this Chapter, additional guidance concerning invitations, seating and protocol may be found in appendix D, in Oretha D. Swartz's *Service Etiquette the Marine Officer's Guide*, fourth edition, and *Handbook for Marine Noncommissioned Officers* published by the Naval Institute Press.

24001. SCHEDULE OF EVENTS. Drawing upon our history and traditions, the following general routine is a standard guideline for Mess Nights, subject to modification as required.

- 1. Key personnel arrive and supervise last minute preparations.
- 2. Members of the mess arrive, the bar is opened and the cocktail hour begins. This is normally 45 minutes before dinner.
- 3. Guest of honor arrives and is met by the escort.
- 4. Fifteen minutes prior to dinner, "*First Call*" or "*Dinner Chimes*" is sounded. At this time all present finish their drinks, make final head calls (since no one will be excused from the dining room during the dinner without permission from the Mess President), and begin assembling for the march on. No drinks or tobacco are to be carried into the dining area.
- 5. Five minutes prior to dinner, "*Officers Call*" is sounded ("*First Sergeant's Call*" is sounded at an enlisted mess). All members form in the order they are to be seated. The official party, who occupies the head table, is the last unit to form and enter the mess. At this time, the smoking lamp is out.
- 6. At the appointed time the drum and trumpet detail plays "*Sea Soldiers*" as the members of the mess march on. Members of the mess march smartly to their assigned seats and remain standing while the entire mess assembles. The official party enters smartly and moves to their assigned position at the head table as "*Semper Fidelis*" is played. When the head table is occupied, the music ceases. All hands remain standing for the grace.

Enclosure (1)

smartly as "*Semper Fidelis*" is played and moves to their assigned position at the head table. When the head table is occupied, the field music ceases, executes the prescribed facing movements, and marches out of the dining room to a single drumbeat. All hands remain standing for the grace.

7. Grace is offered. Either a chaplain, President of the Mess, or Mr./Madam Vice does this.

8. Dinner is served, after the last of the wine and soup is removed, "Parade the Beef."

9. "Shed a Tear." It is optional at the end of the meal to allow a break.

10. Port is served and the smoking lamp lighted. It is customary at this time to open the floor to fining although this may be omitted or done at a different time.

11. Mess President remarks.

12. Introduction of guests and remarks by the guest of honor.

13. Toasting.

14. Secure from the dining room and move to the bar.

15. After dinner activities.

24002. SEQUENCE. This sequence of events is a summation of the night activities, a "refresher" outline for what takes place at a mess night. Times are given for the events prior to and after the meal. Events during the meal are not regulated by time. The following is an example of a mess night sequence.

- 1. The President and Mr./Madam Vice have verified that all arrangements have been made and are standing by to begin the cocktail hour.
- 2. Members of the mess begin arriving prior to the guests. Cash bar provided. Members are reminded to consult the seating chart.
- 3. H Hour-60 Minutes. Cocktail hour begins and guests begin arriving. Guest of honor arrives. All are met by Mr./Madam Vice and introduced to the mess president and members of the mess.
- 4. H Hour-15 Minutes. "*First Call*" or "*Dinner Chimes*" is sounded. All present finish drinks, make final head calls, and begin assembling for the march on.
- 5. H Hour-5 Minutes. Assemble. "*Officer's Call*" or "*First Sergeant's Call*" is sounded. All members assemble [to include any guests] in the order they are to be seated and stand by for the march on. The head table forms last and enters separately.
- 6. H-Hour. March on. Mr./Madam Vice commands "**Forward, MARCH.**" As the members step off, "*Sea Soldiers*" is played. Members and guests march to their place and stand behind their chairs. Once all are in place and the music stops, Mr./Madam President commands "**Forward, MARCH**" for the head table. As the head table steps off, "*Semper Fidelis*" plays. Once the head table is in place the music stops and all remain standing.

Enclosure (1)

7. Mr./Madam Vice: **"Mr./Madam President, all members of the mess and guests are present."**
8. Mr./Madam President: **"Chaplain, offer the grace."** (Note if a chaplain is not present then either Mr./Madam President or Mr./Madam Vice may offer grace.)
9. Mr./Madam President: ***Raps the gavel once*** and states **"Please be seated."** The members will wait until the head table is seated and then sit. Appetizer is served (e.g., shrimp cocktail, salad) and after the last of the soup bowls and glasses are removed the next course will start. Members will not begin eating each course until after the President and guest start.
10. The President stands, ***raps the gavel three times*** and states **"Mr./Madam Vice, bring forth the beef."**
11. Mr./Madam Vice: **"Chief Steward, the beef."** At this time the music "*Roast Beef of Old England*" is played. Mr./Madam Vice accompanies the chief steward to the head table, is handed a small portion of beef and passes it to the President who tastes it.
12. Mr./Madam President: **"I find this beef tasty and declare it fit for human consumption. Please serve the members of the mess."** The beef is removed to the galley for serving. The music "*Roast Beef of Old England*" is played as the beef is removed. The dinner continues until after dessert is finished.

Note: If the mess night is to include fining, the floor may be opened to fining once the main course is served or as an option once the smoking lamp is lighted. The President will close the floor for fining whenever the Marine deems fit.
13. After dessert is finished and while the servers are clearing the table it is optional to allow the members of the mess a short break and make head calls.
  - a. Mr./Madam Vice: After dinner, stands and requests **"Mr./Madam President, I suggest we shed a tear for Lord Admiral Nelson."**
  - b. Mr./Madam President: ***Raps the gavel twice*** (mess stands). **"The mess will adjourn for a 15-minute break."** The official party departs followed by all others. Do not return until called.
  - c. During the break Mr./Madam Vice will ensure that coffee, cigars, ashtrays, matches, and wine for toasting is placed on the tables.
  - d. After 15 minutes and on cue from Mr./Madam Vice, the music "*First Call*" is played. All members and guests return and stand behind their seats. Once all members and guests have returned to their chairs the head table will march in.
14. Mr./Madam Vice: **"Mr./Madam President, all members and guests of the mess are present."** or **"Mr./Madam President, all members and guests of the mess are not present. Name the offenders."**
15. Mr./Madam President: ***Raps gavel once***. "Please be seated" ***Raps gavel three times***. **"Mr./Madam Vice, the smoking lamp."** After Mr./Madam Vice has brought forth the smoking lamp and lighted the cigars of Mr./Madam President, the President announces **"Ladies and Gentlemen, the smoking lamp is lighted."**
16. Mr./Madam President: ***Raps gavel three times***. **"Mr./Madam Vice bring forth the wine for toasting."**

17. Mr./Madam Vice: **"Chief Steward, the wine."** Mr./Madam Vice accompanies the chief steward and pores the wine for the guest of honor and Mr./Madam President. When all glasses are charged, Mr./Madam Vice stands and announces **"Mr./Madam President, all glasses are charged,"** and remains standing.
18. Mr./Madam President: Stands and **raps gavel three times**. Takes wine glass in right hand and announces **"Mr./Madam Vice, a toast to the Commander and Chief, the President of the United States."** If foreign guests are present then the first toast is given to the head of state of that guest and any others in order of seniority. The senior foreign guest would then toast the President of the United States. Appropriate music is played for all foreign heads of state and the *"National Anthem"* played after toasting the President of the United States.
19. Mr./Madam President: Stands and **raps gavel three times**, moves to podium. At this point Mr./Madam President makes opening remarks followed by the introduction of the guests of the mess. Once the guests are introduced Mr./Madam President introduces the guest of honor.
- a. **"Ladies and Gentlemen, it is my personal pleasure and professional privilege to introduce our guest of honor, \_\_\_\_\_."**
  - b. Remarks by guest of honor.
  - c. Presentation of memento to guest of honor.
20. Mr./Madam President: Stands and **raps gavel three times**. **"The floor is now open for toasting."** At this time official, traditional and personal toasts are made per paragraph D-7 and local custom. At most mess nights, the toasts are prearranged to include the loyalty toast, the traditional toast, and the toast to our fallen comrades and a toast to Country and Corps. The toasts are given in the following manner; each Marine selected for a particular toast will stand with glass in right hand, faces Mr./Madam Vice, and states:
- a. \_\_\_\_\_, **"Mr./Madam Vice, (Mr./Madam Vice stands), A toast to the Continental Marines who fought for freedom and liberty."** Mr./Madam Vice will state, **"Ladies and Gentlemen, a toast (all members stand with wine glasses in right hand), to the Continental Marines."** All members raise their glasses, repeat in unison the words of Mr./Madam Vice, **"To the Continental Marines"** drink a portion of their wine, and resume their seats. This sequence is followed for each toast.
  - b. \_\_\_\_\_, **"Mr./Madam Vice, A toast to the Marines of the 19th century who fought from the halls of Montezuma to the shores of Tripoli."** Mr./Madam Vice: **"Ladies and Gentlemen, A toast to the Marines of the 19th century."** Mess: **"To the Marines of the 19th century."**
  - c. \_\_\_\_\_, **"Mr./Madam Vice, A toast to the Marines of World War I who fought from the Argonne Forest to Belleau Wood."** Mr./Madam Vice: **"Ladies and Gentlemen, A toast to the Marines of World War I."** Mess: **"To the Marines of World War I."**
  - d. \_\_\_\_\_, **"Mr./Madam Vice, A toast to the Marines who fought in the Island campaigns of World War II, where uncommon valor was a common virtue."** Mr./Madam Vice: **"Ladies and Gentlemen, A toast to the Marines of World War II."** Mess: **"To the Marines of World War II."**

e. \_\_\_\_\_, "Mr./Madam Vice, A toast to the Marines who fought in Korea from Inchon to the Chosin Reservoir." Mr./Madam Vice: "Ladies and Gentlemen, A toast to the Marines who fought in Korea." Mess: "To the Marines who fought in Korea."

f. \_\_\_\_\_, "Mr./Madam Vice, A toast to the Marines who fought for freedom in Vietnam." Mr./Madam Vice: "Ladies and Gentlemen, A toast to the Marines who fought in Vietnam." Mess: "To the Marines who fought in Vietnam."

g. \_\_\_\_\_, "Mr./Madam Vice, A toast to the Marines who fought oppression in Lebanon and Grenada." Mr./Madam Vice: "Ladies and Gentlemen, A toast to the Marines who fought oppression in Lebanon and Grenada." Mess: "To the Marines of Lebanon and Grenada."

h. \_\_\_\_\_, "Mr./Madam Vice, A toast to the Marines who fought for Kuwait liberty in Southwest Asia." Mr./Madam Vice: "Ladies and Gentlemen, A toast to the Marines of Desert Shield and Desert Storm." Mess: "To the Marines of Desert Shield and Desert Storm."

i. \_\_\_\_\_, "Mr./Madam Vice, A toast to our comrades in arms, the United States Navy Corpsmen." Mr./Madam Vice: "Ladies and Gentlemen, A toast to our comrades in arms, the United States Navy Corpsmen." Mess: "To Navy Corpsmen."

Note: This toast may be omitted if the toast to the United States Navy is done during the official toasts.

j. \_\_\_\_\_, "Mr./Madam Vice, A toast to the Marines currently deployed on the forward edge of our Nation's defense." Mr./Madam Vice: "Ladies and Gentlemen, A toast to Marines currently deployed." Mess: "To Marines currently deployed."

k. In place of the above toasts the procedures outlined in paragraph D-7.7h can be used. During the above sequence the appropriate toasts to other services will be inserted as directed by the President of the Mess.

l. Mr./Madam Vice: "I to have a toast; as you entered this banquet hall, you should have noticed that before us tonight stands an empty chair and a single lone table draped in black, signifying all of our fallen comrades who are not with us this evening, because they have given the full measure of devotion to our Country and to our beloved Corps. The single lighted candle reminds us of the flame of eternal life. That the memory of our fallen comrades will be with us always. The Purple Heart Medal displayed to reflect the shedding of blood and the ebb of life in battle. The identification tags, blank, yet they could bear the name of any of us here tonight. The dinner setting, inverted, they break bread with us in spirit only. Ladies and Gentlemen a toast, To our fallen comrades." Mess: "To our fallen comrades." "TAPS" is played.

21. At this time the President can make appropriate remarks concerning business of the mess to include hail and farewell of members, recent promotions, etc.

22. Mr./Madam President: "Mr./Madam Vice, bring forth the rum punch." Mr./Madam Vice uses the same procedures as for wine and remains standing throughout.

23. Mr./Madam Vice: After all glasses are charged states **"Mr./Madam President, all glasses are charged."**
24. Mr./Madam President: **"In 1776, one of the first recruiting posters ordered recruits upon enlistment, take courage then, seize the fortune that awaits you, repair to the Marine rendezvous, where in a flowing bowl of punch, and three times three you shall drink (pause), long live the United States and success to the Marines. Mr./Madam Vice, a toast to the country and Corps."**
25. Mr./Madam Vice: **"Ladies and Gentlemen, a toast, long live the United States and success to the Marines."** Mess: All repeat, glasses are emptied and inverted. *"Marine's Hymn"* is played. It is more appropriate at this time to have the mess sing all three versus of the Marine's Hymn.
26. Mr./Madam Vice: Ensures those who prepared and served the meal are present and standing behind Mr./Madam Vice's table.
27. Mr./Madam President: ***Raps gavel three times.*** **"Ladies and Gentlemen, join me in a round of applause for the staff who have prepared and served the meal and drinks in honor of our mess this evening and which we have enjoyed."** (Leads applause.)
28. Mr./Madam President: ***Raps gavel three times.*** **"Ladies and Gentlemen, join me at the bar."** Members remain standing until the head table has departed.

MARINE CORPS DRILL AND CEREMONIES MANUAL

PART II: CEREMONIES

CHAPTER 25

FUNERALS AND MEMORIAL SERVICES

	<u>PARAGRAPH</u>	<u>PAGE</u>
GENERAL . . . . .	25000	25-3
DUTIES OF THE OFFICER IN CHARGE OF THE CEREMONY . . . . .	25001	25-5
RECEIVING THE REMAINS . . . . .	25002	25-7
PROCESSION . . . . .	25003	25-10
AT THE GRAVE . . . . .	25004	25-13
MEMORIAL SERVICE HONORS . . . . .	25005	25-17
CONDUCT OF FUNERALS WHEN MILITARY PERSONNEL ARE LIMITED . . . . .	25006	25-19
UNIT OUTDOOR MEMORIAL SERVICES WHEN REMAINS ARE INTERNEED AT DECEASED HOME OF RECORD . . . . .	25007	25-19
UNIT INDOOR MEMORIAL SERVICES WHEN REMAINS ARE INTERNEED AT DECEASED HOME OF RECORD . . . . .	25008	25-21

FIGURE

25-1	RECEIVING THE REMAINS FROM A BUILDING . . . . .	25-6
25-2a	PALLBEARS ENTERING; LEAVING THE CHAPEL . . . . .	25-7
25-2b	ENTERING CHAPEL; LEAVING CHAPEL . . . . .	25-8
25-3	RECEIVING REMAINS AT CEMETERY GATES (TRANSFERRING REMAINS FROM HEARSE OR CAISSON) . . . . .	25-9
25-4	ORDER OF MARCH OF FUNERAL PROCESSION . . . . .	25-12
25-5	RECEIVING THE REMAINS AT THE BURIAL GROUND . . . . .	25-14
25-6	MARCH TO THE GRAVE . . . . .	25-15
25-7	A DISTRIBUTION OF UNITS AT THE GRAVE . . . . .	25-16
25-8	HONOR GUARD . . . . .	25-18
25-9	COMPANY MEMORIAL FORMATION . . . . .	25-21





MARINE CORPS DRILL AND CEREMONIES MANUAL

PART II: CEREMONIES

CHAPTER 25

FUNERALS AND MEMORIAL SERVICES

25000. GENERAL

1. When not contrary to orders and regulations, the extent to which the Naval service participates in a funeral depends upon the expressed wishes of the family of the deceased.
2. The composition and strength of the escort will be as prescribed in *U.S. Navy Regulations* or as modified by proper authority.
3. The military aspect of a funeral usually begins at one of the following places, home of the deceased, mortuary, railroad station, church or chapel, cemetery gates, or the grave. It may, however, begin at any designated place.
4. The ceremony starts when the escort first receives the remains. Before that, the body bearers may be detailed to conduct the remains wherever necessary.
5. In general, the escort receives the body at one of the following places:
  - a. The designated place and conducts it to the place of services and then to the grave.
  - b. The chapel before, and conducts it to the grave after the services.
  - c. The cemetery gates and conducts it to the grave.
  - d. The grave.
6. Each time the body bearers remove the remains:
  - a. The escort is brought to present arms.
  - b. The band renders prescribed honors, followed by appropriate music.
  - c. The pallbearers salute.
  - d. All observers in uniform, except the body bearers, salute.
  - e. All civilian-dressed Naval personnel, except women, uncover and hold the headdress over the heart with the right hand. Women place the right hand over the heart without uncovering.
7. When the national colors is draped on the casket, it shall be placed so the stars are at the head of the casket over the left shoulder of the deceased. Nothing shall rest on top of the national colors. The colors will be removed as the casket is being lowered into the grave, and in time so the colors will not touch the ground.
8. The casket is always carried foot first, except in the case of a clergyman whose casket is carried into and out of the church or chapel head first.

9. Pallbearers may walk or ride, depending upon the distance to be covered.
10. The senior pallbearer will give necessary cautionary commands to the others in a low voice. All salute at the command "**Present, ARMS**" when given by the escort commander.
11. The personal flag of a deceased general or flag officer will be carried immediately in front of the hearse or caisson. If he was a unit commander or ship's captain, the command or commission pennant will also be carried.
12. If the entrance to the cemetery prevents the hearse or caisson from entering, the procession halts, the casket is removed, and the procession proceeds again.
13. When the deceased is entitled, the minute gun salute prescribed by *U.S. Navy Regulations* is fired. The first gun fires as the body enters the cemetery. Three volleys are fired at 5-second intervals as the casket is lowered into the grave.
14. When the band is playing a hymn and it becomes necessary to stop, it continues until the next stanza ends.
15. Uniformed officers in an official capacity will wear a mourning band on the left sleeve. If armed with the sword, its hilt will be affixed with the mourning knot.

Note: No weapons to include swords will be worn or brought into the chapel.

16. Participation by fraternal or patriotic organizations is as follows:
  - a. Fraternal or semi-military organizations of which the deceased was a member may participate in the service if desired by the immediate family.
  - b. If the ritual is military or semi-military, the rites will begin immediately after the military ceremony. If it includes the firing of three volleys and "*Taps*," these features of the military ceremony may be postponed until their appropriate places in the ritual, at which times the military firing party and bugler may render the honors.
17. When the body has been cremated, casket, body, and remains, as used herein, refer to the container of the ashes.
  - a. For all phases of the funeral in which the cremated remains are carried by hand, one enlisted man will be detailed to carry the receptacle. Four enlisted men will be detailed as flag bearers. When the receptacle is carried from a conveyance into the chapel, from the chapel to the conveyance, or from the conveyance to the grave, the flag bearers will follow the receptacle with the flag folded as prescribed in paragraph 7002.6 and carried by the leading flag bearer on the right.
  - b. When the receptacle has been placed on the stand before the chancel of the chapel, or when placed in the conveyance, the flag will be folded and placed inside it. If the caisson is equipped with a casket container for the receptacle, the open flag will be laid on the container as prescribed for a casket.

c. When a hearse or caisson is not used, suitable transportation will be provided the receptacle bearer and flag bearers.

d. When the remains are to be conducted to a crematory and the ashes interred with military honors at a later time, the ceremony will consist only of the escort to the crematory. Arms will be presented as the body is carried into the crematory. Volley firing and "Taps" are omitted. If the funeral is held at the crematory and no further military honors are anticipated, the volleys will be fired (if local ordinances permit) and "Taps" sounded outside the crematory.

#### 25001. DUTIES OF THE OFFICER IN CHARGE OF THE CEREMONY

1. The officer in charge should be detailed in sufficient time before the funeral to allow planning and prior arrangements. The officer in charge will confer with the clergy and funeral director. Together they will ensure that all necessary arrangements have been made. The chaplain will perform the duties of officer in charge of the ceremony in case no other officer is so designated.

2. As soon as the service in the church or chapel has begun, the officer in charge will:

a. Make sure the hearse or caisson is ready to receive the casket at the front entrance.

b. Ensure a conveyance for flowers is posted at the side or rear-entrance.

c. Arrange the cars for the clergy, pallbearers, and immediate family (if the procession is to ride) in the proper order. (See figure 25-1.)

d. Designate four of the body bearers to help carry the flowers out after the body has been placed in the conveyance. They should return through the side or rear door, at whichever the flower conveyance is parked. The remaining body bearers will secure the casket on the caisson or hearse. After the flowers have been moved, the four designated body bearers will take position in rear of the caisson or hearse.

3. When the body is transferred from the hearse to the caisson, the officer in charge will be in the vicinity. He will signal the escort commander when the transfer begins and when it is completed.

4. When the procession is in motion, the officer in charge will go to the grave and await the arrival of the funeral party. He will determine the positions for the band, escort, firing party (if separated from the escort), the bugler, and other units. Upon their arrival, he will direct these individuals and units to their proper positions at the grave.

5. After the units and individuals are in position at the grave, he will signal the body bearers to carry the remains from the conveyance and the band and escort to render the honors.

6. When the widow or mother of the deceased is unaccompanied, the officer in charge will escort her from the car to the grave. When practicable, he will remain with her to render assistance until completion of the commitment.

7. After the commitment service, he will deliver the folded national colors, used on the casket, to the family of the deceased.

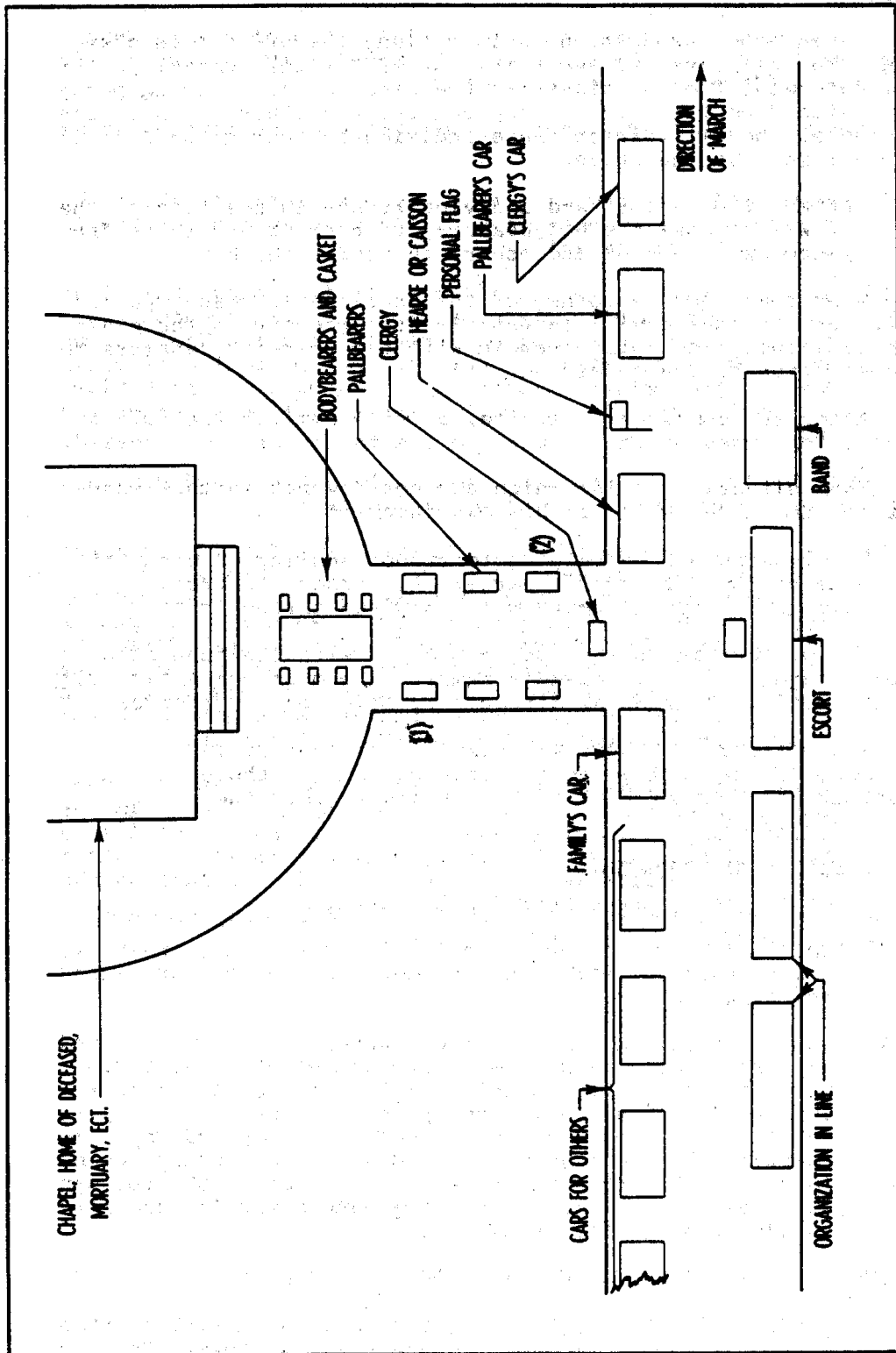

Figure 25-1.--Receiving the Remains from a Building.

8. When situations arise which are not covered in this Manual, the officer in charge will use his/her own judgment.
9. Final decisions pertaining to troop handling or movement will be made by the officer in charge. All orders to troops participating in a funeral party will be given through the officer in charge.
10. The officer in charge must cooperate with the funeral director engaged by the deceased's family. The officer in charge must not arbitrarily assume the duties the funeral director is being paid to perform.
11. The officer in charge will explain the nature and significance of the volleys to the next of kin, or those representing the next of kin, and ascertain whether the volleys are desired.

#### 25002. RECEIVING THE REMAINS

1. Whenever the remains are received, the following procedure will govern. (See figures 25-1, 25-2, and 25-3.)



Figure 25-2a.--Pallbearers Entering; Leaving the Chapel.

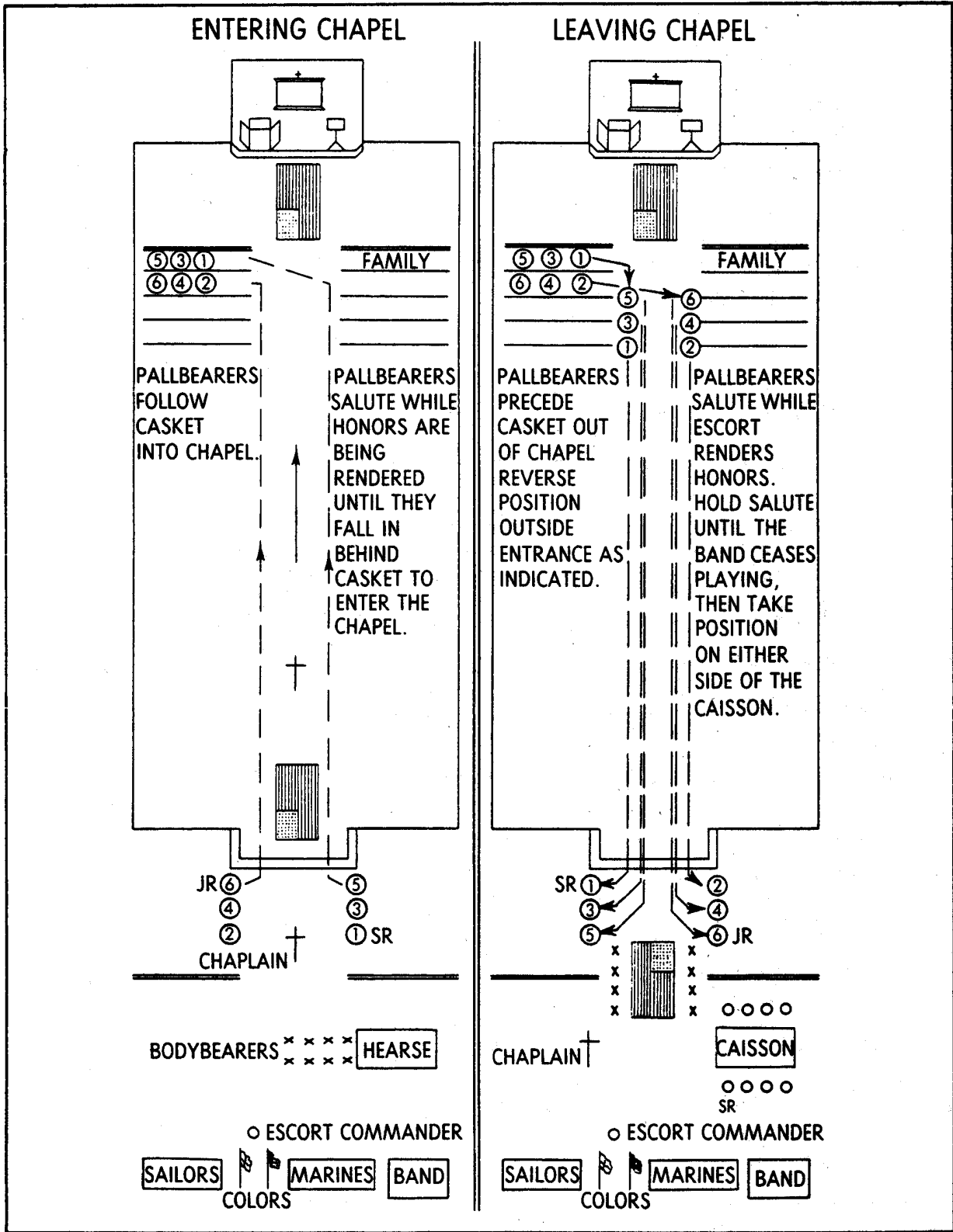

Figure 25-2b.--Entering Chapel; Leaving Chapel.

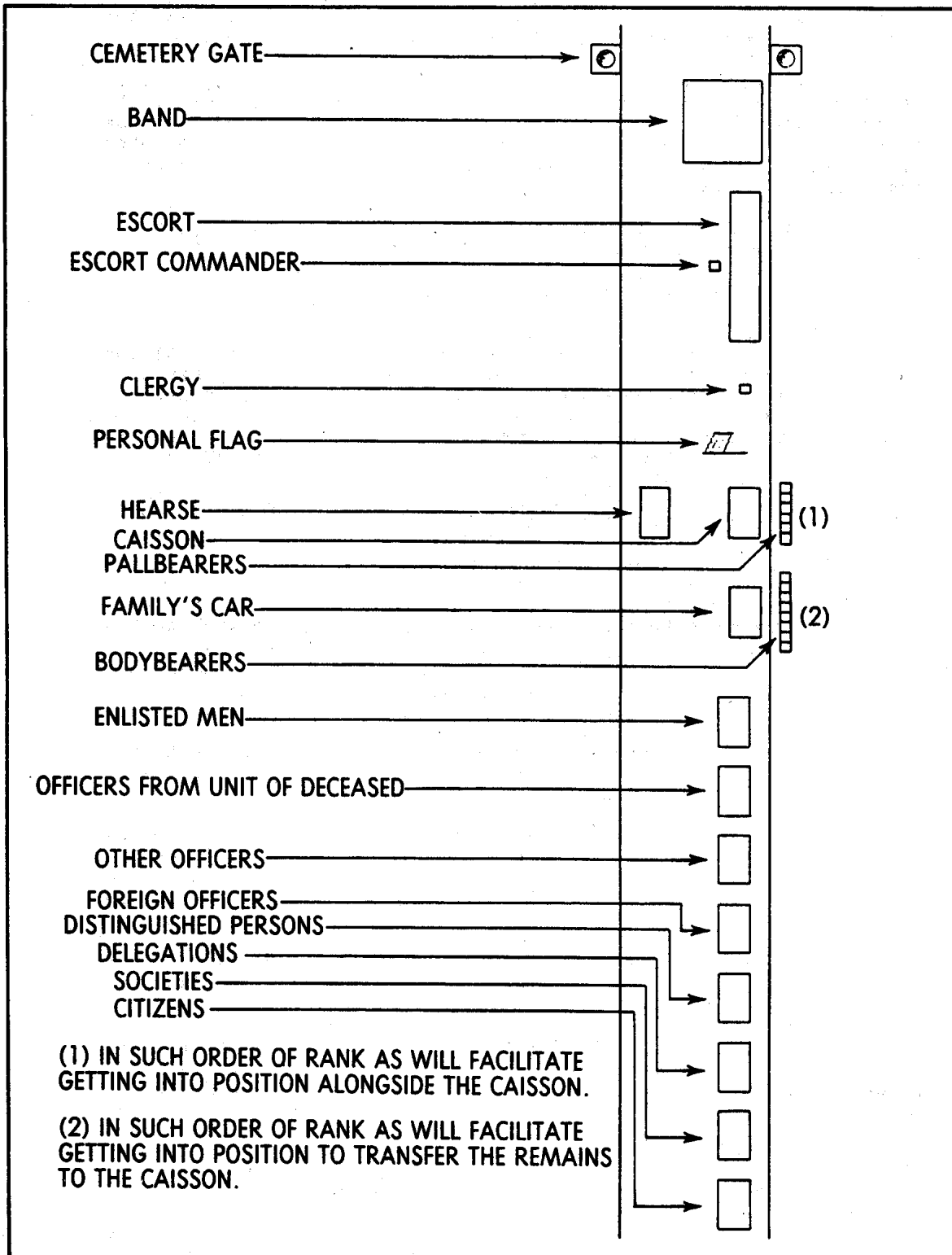

Figure 25-3.--Receiving Remains at Cemetery Gates  
(Transferring Remains from Hearse or Caisson).

2. The escort is formed opposite the place where the remains are to be received. As they arrive, or when all is ready to receive the remains, the commander of the escort commands "**Present, ARMS.**" After the remains have been received, the door to the hearse is closed, or the casket secured to the caisson, and the escort commander orders "**Order, ARMS.**"

3. The band is formed on the flank toward which the escort is to march. At the command of execution for present arms by the escort commander, the band will render musical honors if the deceased is entitled to such honors. Following this, they play appropriate music; stopping at the next stanza ending after order arms has been ordered.

4. The bearer of the personal flag of the deceased takes position and marches in front of the hearse or caisson.

5. Duties of the pallbearers are as follows:

a. When the remains are received at the chapel before the service, form in two ranks facing inboard at the entrance with the juniors nearest the door. They must allow room between ranks for the casket to pass between them. As the casket is removed from the hearse or caisson, they execute the first movement of the hand salute. The second movement is executed as the casket passes, after which they face toward the door and follow the casket into the chapel. Seats are usually reserved for them among the left front pews.

b. When the remains are received from a building (see figure 25-1), assemble inside the building in column of twos, in reverse order of rank, junior to the left front, prepared to march out. They follow the clergy from the building (preceding the casket), open to allow the casket to pass between, halt, face inboard, and salute while the casket is passing. They remain at hand salute until the escort executes order arms. They then take their place in two columns of files on each side of the casket in inverse order of rank, junior to the left front, the leading person of each column opposite the front wheels of the hearse or caisson.

c. When the remains are received at the cemetery gates (see figure 25-3), they form in a single rank on the flank of the escort, opposite the hearse or caisson and in such order of rank that moving to position alongside the caisson is facilitated. They execute and terminate the hand salute on the commands for present and order arms by the escort commander. After present arms, they take their places beside the hearse or caisson as described in paragraph 25002.5b above.

6. The body bearers, if not already with the remains, form on the left of the pallbearers. They leave the formation at the proper time to receive the casket and carry it to the chapel, caisson, or grave. They form, according to height, on each side of the casket. While indoors and not carrying the casket, they uncover. Outdoors they remain covered.

#### 25003. PROCESSION

1. After the remains have been placed in the hearse or caisson and all is ready, the officer in charge of the ceremony signals the escort commander. The escort commander puts the band and escort in motion. Elements in rear follow.

2. The procession forms in the following order: (See figure 25-4.)



- a. Escort commander.
  - b. Band or bugler.
  - c. Escort in suitable formation.
  - d. Clergy.
  - e. Pallbearers if riding.
  - f. Personal flag if rated.
  - g. Casket. If pallbearers are not riding, they form on either side of the hearse or caisson as described in paragraph 25002.5b. If the pallbearers ride, the body bearers take the place of the pallbearers.
  - h. Body bearers in column of twos behind the hearse or caisson.
  - i. Family of the deceased.
  - j. Enlisted men.
  - k. Officers from the ship or organization of the deceased, in inverse order of rank.
  - l. Other officers in inverse order of rank.
  - m. Foreign officers.
  - n. Distinguished persons.
  - o. Delegations.
  - p. Societies.
  - q. Citizens.
3. The procession marches in slow time to solemn music.

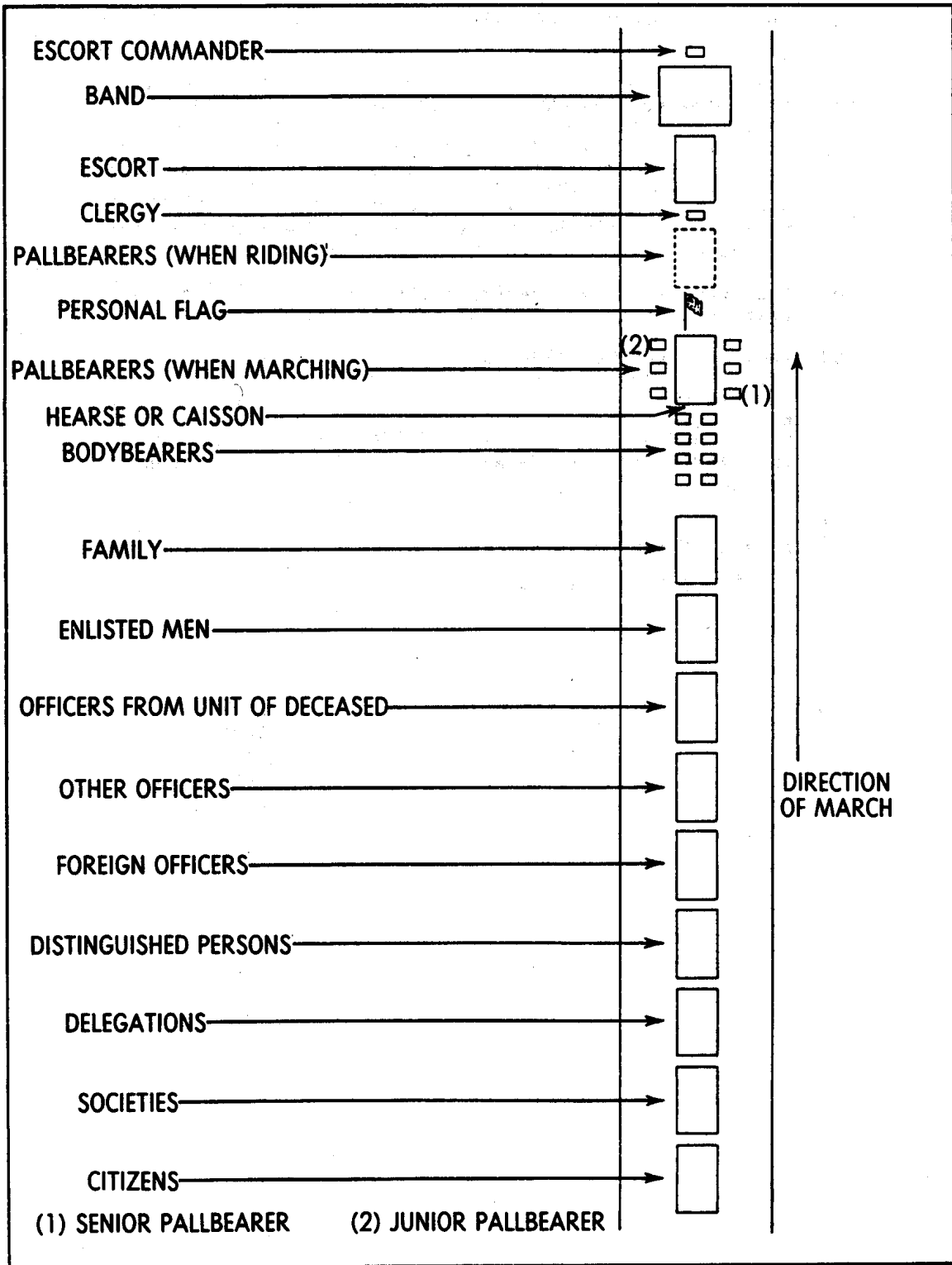

Figure 25-4.--Order of March of Funeral Procession.

25004. AT THE GRAVE

1. As the procession arrives at the grave, units turn out of column and take the following positions: (See figure 25-5.)
  - a. The band forms in line with and on the right of the escort.
  - b. The escort forms in line facing the grave at a position indicated by the officer in charge of the ceremony. It should be at least 50 feet from the grave so the volleys will not disturb the mourners. The terrain may dictate that the formation be inverted with the band on the left.
  - c. The clergy forms between the hearse or caisson and the grave.
  - d. The bearer of the personal flag of the deceased takes post between the clergy and the caisson or hearse.
  - e. The pallbearers form in two ranks between the clergy and the grave. They face each other with the juniors nearest the grave. They allow room between their ranks to permit passage of the casket.
  - f. The family of the deceased remains near the caisson or hearse.
  - g. Other units form in separate lines near and facing the grave. Their positions are indicated by the officer in charge of the ceremony.
2. When all units are in position and upon signal of the officer in charge of the ceremony, the body bearers remove the casket from the caisson or hearse. They carry it between the pallbearers and in front of the escort, then place it on the lowering device over the grave. They raise the national colors by the corners and sides and hold it waist or shoulder high until the end of the service.
3. As the body bearers remove the casket from the caisson or hearse: (See figure 25-6.)
  - a. The escort commander commands "**Present, ARMS.**" The band renders prescribed honors, if rated, after which they play appropriate music. The music stops when the casket is placed on the lowering device.
  - b. The escort presents arms until the casket is placed on the lowering device.
  - c. The clergy precedes the personal flag and the casket to the grave.
  - d. The flag bearer follows the clergy, preceding the casket, and takes position at the head of the grave. The flag bearer remains there during the service.
  - e. The pallbearers salute as the casket passes between them. When the casket has passed, they terminate the salute, face the grave, close interval, and follow the casket. Upon arrival at the grave, they form in two ranks facing the grave, usually just in rear and to one side of the clergy.
  - f. The family of the deceased follows the pallbearers and takes position provided for them.

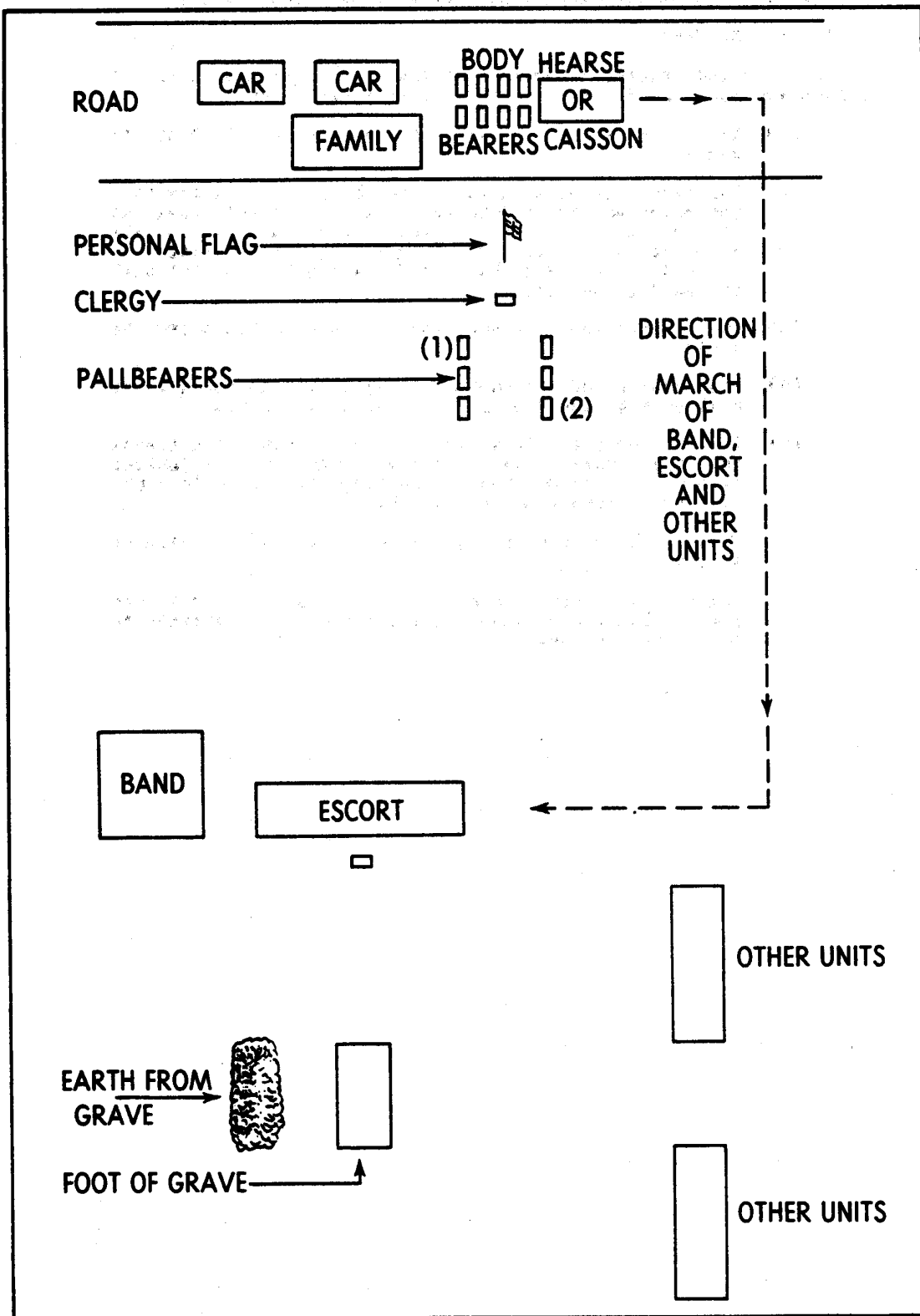

Figure 25-5.--Receiving the Remains at the Burial Ground.

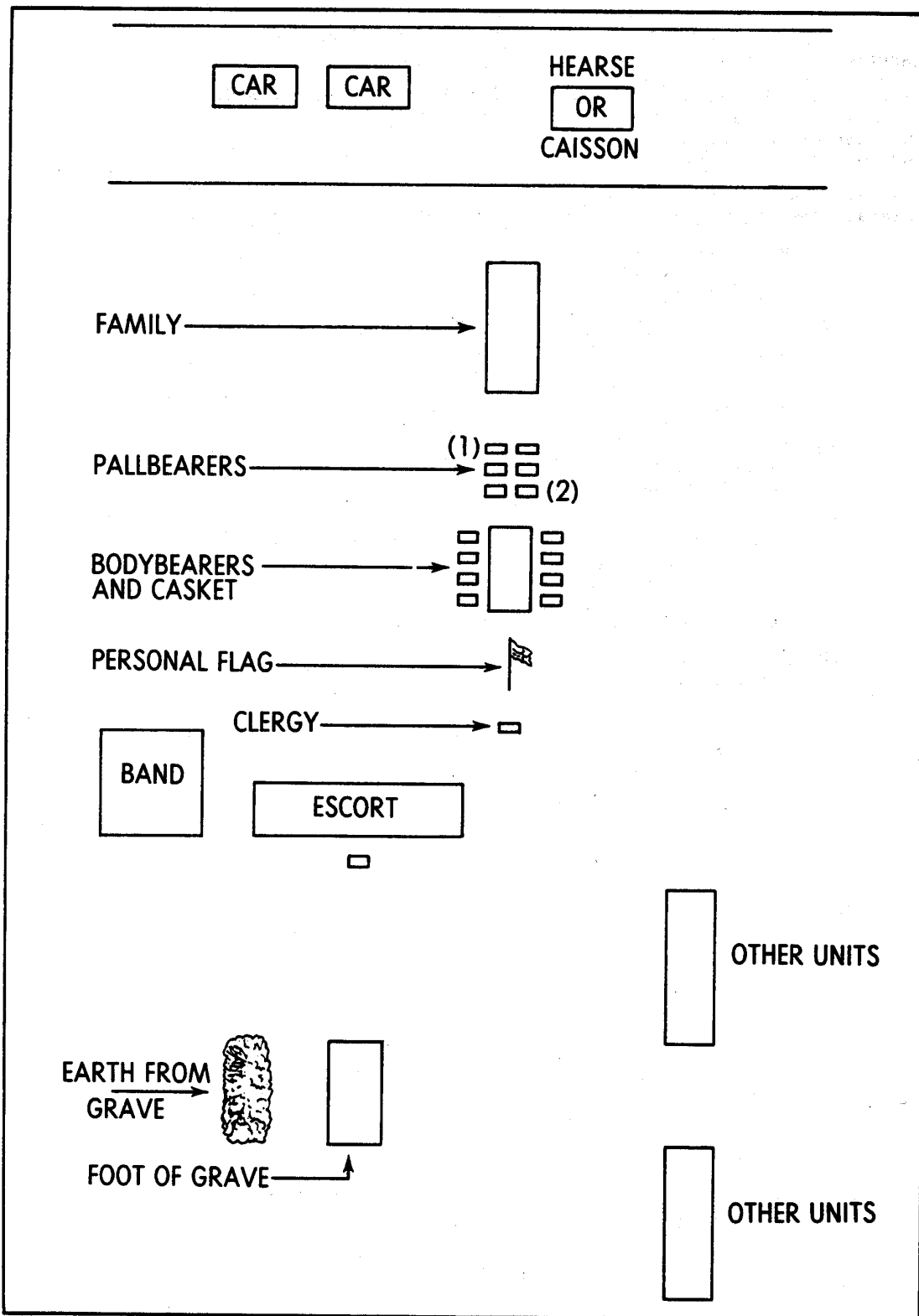

Figure 25-6.--March to the Grave.

4. When the casket is placed on the lowering device and the family has arrived, the following occurs: (See figure 25-7.)

- a. The escort commander orders "Order, ARMS" and "Parade, REST." Members of the escort execute parade rest.
- b. Pallbearers and other units execute parade rest on the escort commander's order.
- c. The body bearers remain in their positions, holding the national colors so it will not touch the ground when the casket is lowered.
- d. The clergy conducts the commitment service.

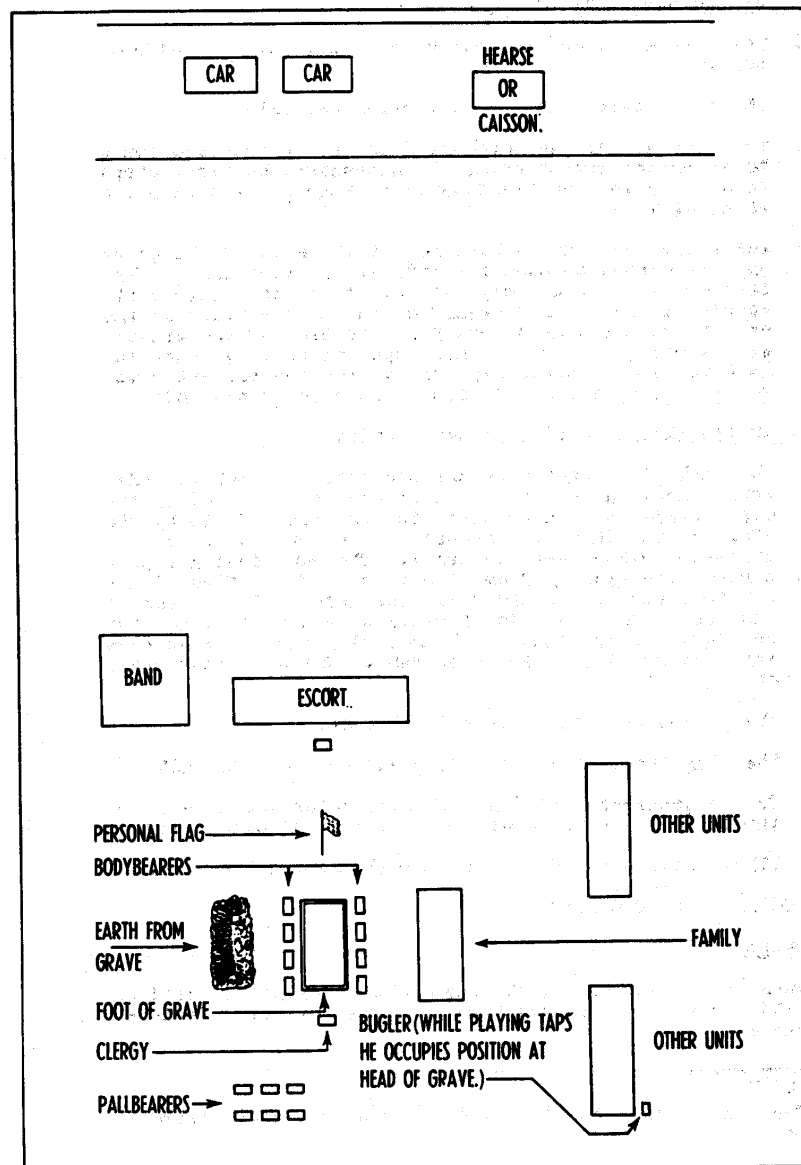

Figure 25-7.--A Distribution of Units at the Grave.

5. After the commitment service:

a. The escort commander orders "**Escort, ATTENTION,**" the escort commander then commands "**Escort, Present, ARMS.**" The noncommissioned officer in charge of the firing party then gives the command (see chapter 26) for the firing of volleys. The firing party executes present arms after completion of the three volleys. When sufficient troops are not available for a separate firing party, the front squad of the escort will be designated as the firing party.

b. The pallbearers come to attention on the command of the escort commander and salute on the Marine's command for present arms.

c. Other units are brought to attention and present arms at the same time as the escorts.

d. The clergy come to attention, and if in uniform, salute.

e. The bandleader comes to attention and salutes.

→ f. The bearer of the personal flag of the deceased comes to attention and salutes. If necessary, the Marine first steps aside to allow the bugler to take position for sounding "*Taps*."

→ g. The bugler takes position at the head of the grave on the escort commander's order to present arms. (The officer in charge may direct that the bugler assume a position forward of and to the flank of the escort rather than directly at the head of the grave). The Marine salutes, and then sounds "*Taps*" immediately after the last volley and the firing party executes present arms. The bugler salutes again, faces about, and rejoins his/her unit.

6. After the last note of "*Taps*" has sounded:

a. The escort commander brings the entire escort to order arms, and after the colors has been folded by the body bearers and presented to the next of kin by the officer in charge, marches the escort and band to a suitable place for dismissal. The band does not play during the march from the grave. The firing party's weapons are unloaded and inspected. If the escort and band continue in formation after cemetery, they remove all mourning and muffling from any colors that may be present. The band then plays march music. Mourning and muffling includes the removal of mourning streamers and bunting from all colors, removal of mourning bands and mourning knots from personnel and swords, and the removal of muffling devices from band instruments.

b. The pallbearers fall out and withdraw.

c. The flag bearer folds the flag and rejoins his/her unit.

d. The body bearers fold the national colors and give it to the officer in charge of the ceremony and march away.

e. Other units march from the vicinity behind the escort.

25005. MEMORIAL SERVICE HONORS

1. Upon the request of the next of kin, memorial services will be held for Naval personnel whose remains have been declared non-recoverable.

Enclosure (1)

- 2. An honor guard is assigned and shall consist of the personnel listed in figure 25-8.

MEMBERS	FULL HONORS (OFFICERS ONLY)	HONORS (ENLISTED, OFFICERS IF SO REQUESTED)
SQUAD LEADER	1	
SQUAD	12	
COLOR GUARD	4	4
BUGLER	1	1
OFFICER IN CHARGE (REPRESENTATIVE OF THE NAVAL DISTRICT COMMANDANT OR DISTRICT MARINE OFFICER)	1	1
CHAPLAIN (IF REQUESTED)	1	1
COLOR BEARER	<u>1</u>	<u>1</u>
TOTAL	21	8

Figure 25-8.--Honor Guard.

3. The ceremony is conducted as follows:

a. The color bearer is present in the rear of the church or chapel before the arrival of the next of kin. At the exact time set for the service to begin (if next of kin has arrived), the color bearer carries the folded national colors down the center aisle to the altar. The Marine places it on the rostrum, where it remains throughout the ceremony, and retires to the wall on the left of the congregation. For the remainder of the service, the Marine stands at attention, facing inward, just in front of the first pew.

b. The honor guard, with color guard on their left, forms outside the church or chapel exit that will be used by the next of kin as the individual leaves. They remain at ease outside the church or chapel during the service. When "Taps" is sounded, they come to attention.

- c. The bugler takes position in the vestibule or other room, separate from the congregation.
- d. If requested by the next of kin, the chaplain conducts the service. Otherwise, the family minister or priest presides.
- e. At the conclusion of the service, the bugler sounds "Taps."
- The chaplain presents the national colors to the next of kin. If a family minister has officiated or the rank of the deceased requires, this duty is performed by the officer in charge.

Enclosure (1)



g. While presenting the flag, or after the flag has been presented by the chaplain the officer in charge pays respects and offers the condolences of the District Marine Officer. The chaplain speaks to the next of kin if he/she did not present the flag.

h. The officer in charge escorts the next of kin from the church or chapel.

i. The honor guard and color guard are called to attention by the squad leader (senior color bearer if squad is not present) upon the appearance of the next of kin. As the next of kin approaches to within 6 paces, the squad leader orders **"Present, ARMS."** The position of present arms is retained until the squad leader is directed to give order arms by the officer in charge. This will be after the next of kin has departed the vicinity.

j. All participating personnel are dismissed.

- 25006. CONDUCT OF FUNERALS WHEN MILITARY PERSONNEL ARE LIMITED. When personnel are limited, military honors for funerals may be efficiently rendered by a detail of eight Marines and one bugler. The firing squad will stack-arms at the place from which volleys will be fired, which should be approximately 50 feet from the head of the grave. They then will return to the hearse and convey the body to the grave. After placing the casket over the grave, six members of the party will take position as the firing squad while the remaining two members remain at the grave and hold the flag over the casket during the service and rendition of military honors. The bugler should take position approximately 50 feet from the head of the grave until the volleys have been fired, at the conclusion of which the Marine shall sound "*Taps*." Then the two members holding the flag shall fold it. The flag will be handed either to the Marine in charge of the detail or to the military escort commander. The escort commander will present it to the next of kin in a dignified manner with a short statement such as **"On behalf of the President, the Commandant of the Marine Corps, and Marines everywhere, please accept this flag in memory of the honorable and faithful service performed by (relationship)."**

25007. UNIT OUTDOOR MEMORIAL SERVICES WHEN REMAINS ARE INTERNED AT DECEASED HOME OF RECORD

1. There may be times when conducting a memorial service in a chapel is not possible or desirable. Such as in a combat situation, where no chapel is available, or when the commander desires to have an all hands, out-of-doors, memorial service. An out-of-door memorial service normally consists of: final roll call; boots and rifle ceremony; eulogy; and firing detail. This type of memorial service is for those Marines killed in the line of duty (e.g., killed in action (KIA), while a sentry on post, training accident.)

2. Normally this type of memorial service is conducted at company, or units of a similar size, level. The formation is company line, platoon line. (See figure 25-9.)

3. The personnel support required, in addition to the company, is:

a. A "boots and rifle" detail consisting of three Marines for each KIA (one carries a rifle with fixed bayonet, one carries a helmet, one carries a pair of boots and set of identification tags) are positioned 6 paces in front of and centered on the company commander. (See figure 25-9.) The rifle bearer is in the center, the helmet bearer is on the right and the boots/dog tag bearer is on the left.

Enclosure (1)

b. Firing detail positioned on the left front of the company, but facing so as not to fire over the formation. (See figure 25-9.)

c. Bugler. Positioned on the right front of the company. (See figure 25-9.)

d. Chaplain. (If available) Positioned near the company commander.

4. The recommended sequence of events is as follows:

a. H-15 Minutes. Company is formed as described in chapter 10, The "boots and rifle" detail(s), firing detail, bugler and chaplain are in position and at parade rest. (See figure 25-9.)

b. H-Hour. The company commander calls the company to attention, then faces about so as the company is to his/her rear. The chaplain then announces "**LET US PRAY,**" and leads the company in prayer. (If no chaplain is available the company executive officer or company gunnery sergeant reads the "Marine's Prayer.") After the prayer is finished the company commander faces the company and commands "**FIRST SERGEANT.**"

c. The first sergeant moves to a position 3 paces in front of the company commander and halts. The company commander then directs the first sergeant to "**READ THE FINAL ROLL CALL.**" The first sergeant faces the company and reads the roll of the Marines being honored (e.g., "**LANCE CORPORAL JOSEPH S. BANOTZ, 2D SQUAD, 3RD PLATOON, INDIA COMPANY, 7TH MARINE REGIMENT. KILLED IN ACTION 25 MARCH 1968 WHILE IN ACTION AGAINST AN ENEMY FORCE IN QUANG NAM PROVINCE, REPUBLIC OF VIETNAM**"). (Similar information is read for each KIA.)

d. As each Marine's name is read, the three Marines representing him execute the following movements:

(1) The rifle bearer takes one step forward, halts, rotates the rifle counter clockwise until the bayonet is facing down and the magazine well is towards the company, sticks the bayonet into the ground, then steps back.

(2) The helmet bearer then steps forward, places the helmet on the butt of the rifle and steps back.

(3) The boots/dog tag bearer then steps forward, hangs the dog tags from the pistol grip, places the boots in front of the rifle (toes towards company) and steps back. This process is repeated as each KIA's name is read.

e. After the last KIA's name is read, the first sergeant returns to his/her post behind the company. The company commander then commands "**Parade, REST.**" The company commander then talks about each Marine, where they were from, how long they were with the company, etc. After each Marine has had a "eulogy" the company commander then commands "**Company, ATTENTION**" and "**Present, ARMS.**" The company and "boots and rifle" detail(s) execute. The company commander then faces about and commands "**HONOR THE DEAD.**" The company commander and guide then present arms.

f. The noncommissioned officer in charge of the firing detail has the detail fire three volleys, and go to present arms as described in chapter 26. The bugler then plays "Taps." After the last note of "Taps" the company commander and guide go to the order. The company commander then faces about and commands "**Order, ARMS.**" All hands go to order arms.

g. The company commander or first sergeant, as described in chapter 10 then dismisses the company.

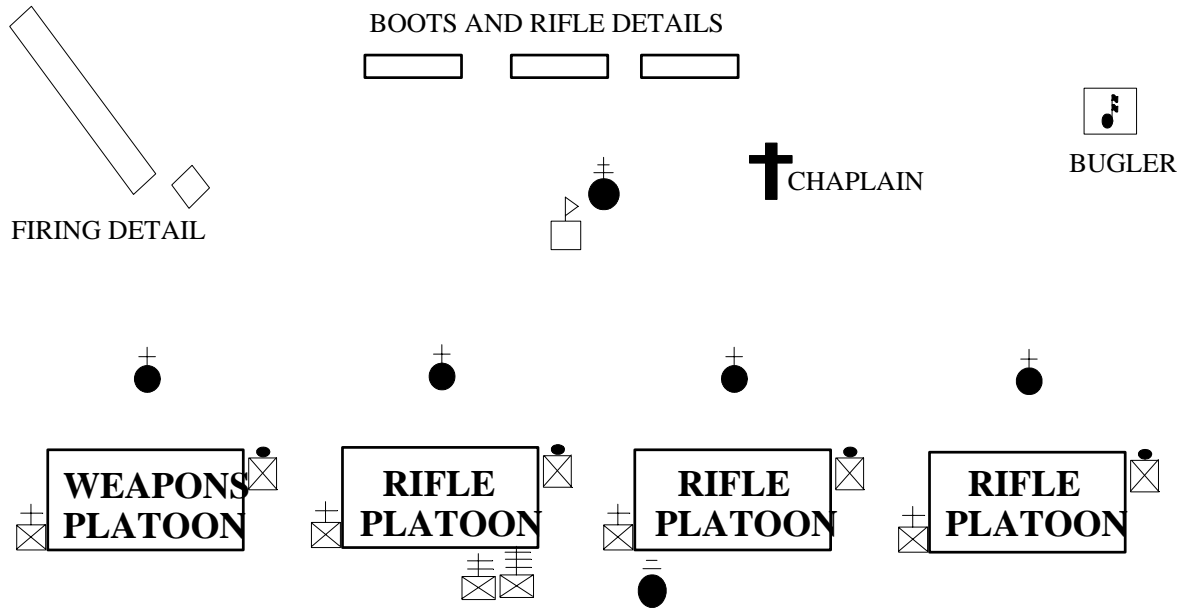

Figure 25-9.--Company Memorial Formation.

25008. UNIT INDOOR MEMORIAL SERVICES WHEN REMAINS ARE INTERNED AT DECEASED HOME OF RECORD

1. When conducting memorial services in a chapel the key thing to remember is that the chaplain has the final authority. Close coordination with the chaplain and the family (if present) is required. Although each religion has variations in their services, the basic memorial service would follow a sequence of events something like the following:

- a. Prelude. Musical selections.
- b. Welcome. Usually by the chaplain or commander.
- c. Posting of the colors and "*National Anthem*." (See paragraph 7307.) The color guard is uncovered and unarmed and the riflemen may be omitted.
- d. Invocation (posting of colors and invocation may be reversed).
- e. Bible readings, hymns, eulogies, etc. (Navy Hymn, Marine's Prayer, etc.).
- f. Call the Roll; after the eulogy, the unit commander will stand and command "**CALL THE ROLL.**" The first sergeant (or platoon sergeant, etc.) will stand and begin calling the roll of members of the deceased's unit who are in attendance. They will answer "**Present.**" This will be done three times. The fourth name to

be called will be the deceased. The first sergeant will repeat the name three times, each time increasing the volume. After the third time the bugler will play "Taps."

Note: If the deceased's family desires not to have "Call the Roll" then this will be omitted and only "Taps" played.

g. "Taps."

h. Benediction and retiring of the colors (may be in any order).

2. If a firing detail is used during an indoor memorial service, the detail fires three volleys just before "Taps." The detail is outside the chapel, and fires in a direction away from the chapel.

MARINE CORPS DRILL AND CEREMONIES MANUAL

PART II: CEREMONIES

CHAPTER 26

LOADING AND CEREMONIAL FIRING OF THE M16 RIFLE

	<u>PARAGRAPH</u>	<u>PAGE</u>
GENERAL . . . . .	26000	26-3
TO LOAD . . . . .	26001	26-3
TO FIRE BY VOLLEY . . . . .	26002	26-6
TO UNLOAD . . . . .	26003	26-7

FIGURE

26-1	FIRING PARTY FORMED FOR CEREMONIAL FIRING . . . . .	26-3
26-2	RIFLEMEN FACE HALF RIGHT . . . . .	26-4
26-3	RIFLEMEN MOVES THE LEFT FOOT 12 INCHES TO THE LEFT.	26-4
26-4	RIFLE TO PORT ARMS . . . . .	26-5
26-5	CHAMBERING A ROUND . . . . .	26-5
26-6	FIRING PARTY IN POSITION OF AIM AND FIRE . . . . .	26-6



MARINE CORPS DRILL AND CEREMONIES MANUAL

PART II: CEREMONIES

CHAPTER 26

LOADING AND CEREMONIAL FIRING OF THE M16 RIFLE

26000. GENERAL

1. For ceremonial firing of the rifle, only the front rank of units larger than a squad executes the loading and firing of the rifle.
2. Normally a firing detail will consist on one noncommissioned officer and seven riflemen. When inadequate manpower is available to provide a full firing detail then one noncommissioned officer and at least three riflemen should be provided. The firing detail should be composed of an odd number of riflemen to honor ancient naval superstitions and traditions.
3. Except during actual firing, loaded rifles are kept on SAFE without command until **"UNLOAD"** or **"Inspection, ARMS"** is ordered.
4. In order to enhance the appearance of the firing party, magazines with three rounds will be inserted into the rifle out of view of spectators. Two expended cartridges should be placed in the magazine below the three blank cartridges so that adequate tension will be placed on the magazine spring. A round will not be placed in the chamber until the command **"LOAD"** is given.

26001. TO LOAD

1. The firing party is formed in line, with the noncommissioned officer in charge 3 paces in front of and 1 pace to the right of the firing party.
2. With the firing party formed and at attention (see figure 26-1), the command is **"With Blank Ammunition, LOAD."** The movements are executed quickly and smartly.



Figure 26-1.--Firing Party Formed for Ceremonial Firing.

3. On the command **"LOAD,"** members of the firing party execute the following sequence of movements:

- a. Face half right. (See figure 26-2.)



Figure 26-2.--Riflemen Face Half Right.

b. Move the left foot 12 inches to the left. (See figure 26-3.) The legs are kept straight so the weight of the body rests equally on both feet.



Figure 26-3.--Riflemen Moves the Left Foot 12 Inches to the Left.



- c. Raise the rifle to port arms. (See figure 26-4.)



Figure 26-4.--Rifle to Port Arms.

- d. Pull the charging handle fully to the rear with the right hand and release it, thus chambering a round of blank ammunition. (See figure 26-5.)



Figure 26-5.--Chambering a Round.

- e. Move the right hand to the piston grip.

26002. TO FIRE BY VOLLEY

1. After the rifles are loaded as described in paragraph 26001, the noncommissioned officer in charge of the firing party orders, **"Ready, Aim, FIRE."**
2. On **"Ready,"** each rifleman moves the selector lever from SAFE to SEMI-AUTOMATIC with the right thumb.
3. On **"Aim,"** each rifleman raises the rifle to a position of 45 degrees from the horizontal, places the butt of the rifle firmly in the right shoulder, and rests the handguard in the "V" formed by the thumb and forefinger of the left hand. The fingers are extended and joined. The left wrist is straight. The right hand is wrapped around the pistol grip from the right. The right elbow is raised to near shoulder height. The head is turned 90 degrees to the left and held erect. Both eyes remain open with the right eye looking out over the front sight. (See figure 26-6.)



Figure 26-6.--Firing Party in Position of Aim and Fire.

4. On **"FIRE,"** squeeze the trigger quickly and lower the rifle to the position of port arms.
5. To continue firing with weapons equipped with blank firing adapters, the commands are **"Aim, FIRE."** Each command is executed as explained above.
6. To continue firing with weapons not equipped with blank firing adapters, the commands are **"Ready, Aim, FIRE."**
  - a. On **"Ready,"** each rifleman manually chambers the next round.
  - b. **"Aim"** and **"FIRE"** are executed as describe above.

7. After the last round has been fired, rifles are brought to the position of port arms. From this position the noncommissioned officer in charge of the firing party gives the command of "**Present, ARMS.**" This movement is executed in three steps on the command of execution "**ARMS.**"

a. With the left foot extended, pivot on the heel of the left foot and toe of the right foot, as in the first count of a left face.

b. Bring the heel of the right foot smartly against the heel of the left foot, completing the left face.

c. The riflemen then moves the rifle to present arms. The noncommissioned officer in charge of the firing party then executes a right face and present sword.

8. After the ceremony, (memorial service, funeral, etc.) the firing party is brought to order arms, faced to the right and marched from the site of the ceremony.

26003. TO UNLOAD

1. The weapons will be unloaded and inspected as soon as possible after leaving he site of the ceremony and out of sight of the spectators, if possible.

2. The command is "**UNLOAD.**" It is executed by executing inspection arms with magazine as describe in paragraphs 3113.1 and 3113.2.

MARINE CORPS DRILL AND CEREMONIES MANUAL

APPENDIX A

MANUAL OF ARMS WITH THE M1 SERVICE RIFLE

	<u>PARAGRAPH</u>	<u>PAGE</u>
GENERAL . . . . .	A-1	A-3
ORDER ARMS . . . . .	A-2	A-4
TRAIL ARMS FROM ORDER ARMS . . . . .	A-3	A-5
FIX BAYONETS . . . . .	A-4	A-6
SLING ARMS . . . . .	A-5	A-7
PORT ARMS FROM ORDER ARMS . . . . .	A-6	A-7
PRESENT ARMS FROM ORDER ARMS . . . . .	A-7	A-8
ORDER ARMS FROM PRESENT OR PORT ARMS . . . . .	A-8	A-9
INSPECTION ARMS FROM ORDER ARMS . . . . .	A-9	A-10
PORT ARMS FROM INSPECTION ARMS . . . . .	A-10	A-12
RIGHT SHOULDER ARMS FROM ORDER ARMS . . . . .	A-11	A-13
PORT ARMS FROM RIGHT SHOULDER ARMS . . . . .	A-12	A-14
ORDER ARMS FROM RIGHT SHOULDER ARMS . . . . .	A-13	A-15
RIGHT SHOULDER ARMS FROM PORT ARMS . . . . .	A-14	A-16
LEFT SHOULDER ARMS FROM ORDER ARMS . . . . .	A-15	A-18
PORT ARMS FROM LEFT SHOULDER ARMS . . . . .	A-16	A-18
ORDER ARMS FROM LEFT SHOULDER ARMS . . . . .	A-17	A-19
LEFT SHOULDER ARMS FROM PORT ARMS . . . . .	A-18	A-19
RESTS WITH THE RIFLE . . . . .	A-19	A-19
ATTENTION FROM REST POSITIONS . . . . .	A-20	A-20
RIFLE SALUTES . . . . .	A-21	A-21
TO STACK ARMS . . . . .	A-22	A-22
TO TAKE ARMS . . . . .	A-23	A-25
LOADING AND CEREMONIAL FIRING OF THE RIFLE . . . . .	A-24	A-26

MARINE CORPS DRILL AND CEREMONIES MANUAL

FIGURE

	<u>PAGE</u>
A-1 M1 RIFLE NOMENCLATURE . . . . .	A-3
A-2 LEFT HAND AT THE RIFLE BALANCE . . . . .	A-4
A-3 POSITION OF ORDER ARMS . . . . .	A-5
A-4 POSITION OF TRAIL ARMS . . . . .	A-6
A-5 PORT ARMS FROM ORDER ARMS . . . . .	A-8
A-6 PRESENT ARMS FROM ORDER ARMS . . . . .	A-9
A-7 ORDER ARMS FROM PRESENT ARMS . . . . .	A-10
A-8 ORDER ARMS FROM PORT ARMS . . . . .	A-10
A-9 INSPECTION ARMS FROM ORDER ARMS . . . . .	A-11
A-10 PORT ARMS FROM INSPECTION ARMS . . . . .	A-12
A-11 RIGHT SHOULDER ARMS FROM ORDER ARMS . . . . .	A-13
A-12 PORT ARMS FROM RIGHT SHOULDER ARMS . . . . .	A-14
A-13 ORDER ARMS FROM RIGHT SHOULDER ARMS . . . . .	A-15
A-14 RIGHT SHOULDER ARMS FROM PORT ARMS . . . . .	A-17
A-15 PORT ARMS FROM LEFT SHOULDER ARMS . . . . .	A-18
A-16 PARADE REST WITH THE RIFLE . . . . .	A-20
A-17 RIFLE SALUTE AT RIGHT SHOULDER ARMS . . . . .	A-21
A-18 RIFLE SALUTE AT ORDER OR TRAIL ARMS . . . . .	A-22
A-18a STACK ARMS, PASSING THE LEFT RIFLE . . . . .	A-23
A-18b STACK ARMS, PLACING THE LEFT RIFLE . . . . .	A-24
A-18c STACK ARMS, PLACING THE RIGHT RIFLE . . . . .	A-24
A-18d STACK ARMS, STACK COMPLETE . . . . .	A-25
A-18e CLOSE UP OF STACKING SWIVELS . . . . .	A-25
A-19 ENGAGING THE OPERATING ROD HANDLE . . . . .	A-27
A-20 FIRING PARTY AT POSITION OF FIRE . . . . .	A-28

## APPENDIX A

## MANUAL OF ARMS WITH THE M1 SERVICE RIFLE

A-1. GENERAL

1. This Appendix is designed to provide detailed instructions for the manual of arms for the M1 service rifle for those units and organizations that use this weapon for ceremonial purposes.
2. The balance is the center of your rifle. (See figure A-1.) In performing the manual of arms it is often necessary to hold the rifle in your left hand for balance. (See figure A-2.) In so doing, the rifle is held between the thumb and fingers. Include the sling in your grip. Keep your fingers straight and together. Your thumb and fingers form a "U."
3. When the rifle is held across your body (see figure A-2), the barrel will cross the point where your neck and left shoulder join. The butt will be in front of your right hip. The rifle is held in the palm of your left hand at the balance. Your wrist is straight.
4. The cadence for rifle movement is 112 to 120 counts per minute.
5. While marching at double time, the rifle will be held across your body.
6. The manual of arms or the rifle is taught while halted. However, to add interest to drill or lessen fatigue, right (left) shoulder arms and port arms may be commanded when marching at quick time. These commands are given as the right foot strikes the deck and execution is begun as the left foot next strikes the deck.

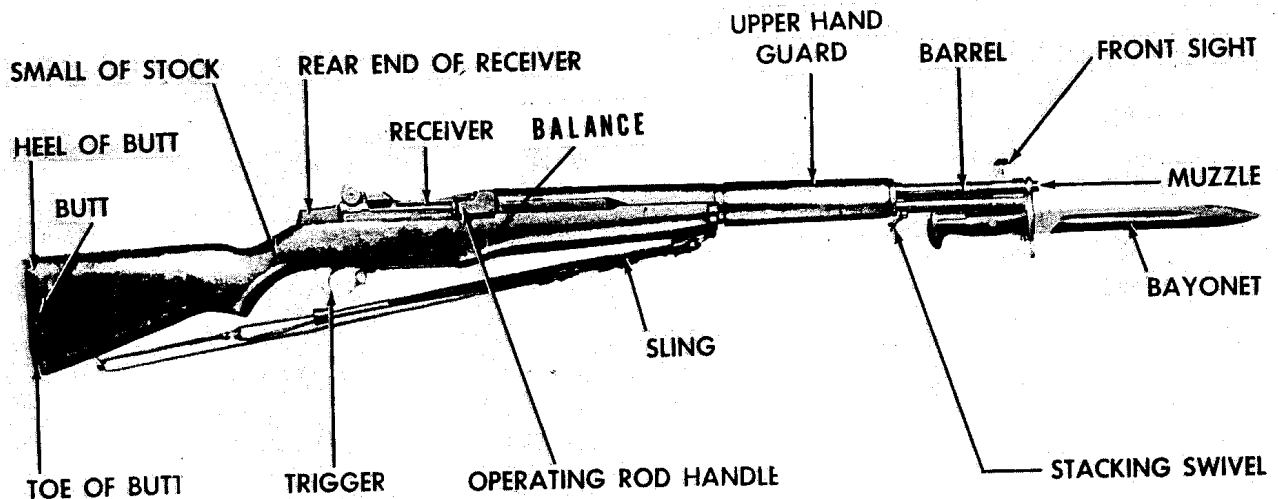

Figure A-1.--M1 Rifle Nomenclature.



Figure A-2.--Left Hand at the Rifle Balance.

A-2. ORDER ARMS

1. When halted, come to order arms when any of the following commands are given: **"Squad (Platoon or Company), ATTENTION; FALL IN; or Order, ARMS."**
2. At the command of execution, place the butt on the deck along the outer edge of the right shoe. The toe of the butt is on line with the toe of the shoe. The rifle's upper hand guard rests in a "V" formed by your thumb and forefinger. All fingers are straight and joined. Your right hand and arm are behind the rifle. This may cause a slight bend in your elbow. The tips of your thumb and forefinger are kept on line with the open edge of the upper hand guard. Your right thumb should also be along the trouser seam. Except for your right hand, the entire body is at attention. (See figure A-3.)



a. Front View



b. Side View.

Figure A-3.--Position of Order Arms.

A-3. TRAILS ARMS FROM ORDER ARMS

1. The command is "**Trail, ARMS.**" It may be given only from order arms. It is executed in one count. On "**ARMS,**" close the fingers and thumb of your right hand around the upper hand guard. This will raise the rifle butt 2 inches from the deck and point the muzzle slightly forward. Do not bend your elbow. In the proper position the rifle will form a 15-degree angle with your leg. (See figure A-4.) Remain at trail arms until order arms is given.

2. Trail arms is used for short distance movements. If a marching movement (a side step, back step, or forward march) is ordered while at order arms come to trail arms automatically on the command of execution for the marching movement. The same applies for facing movements, while at order arms. Whenever trail arms is automatically assumed, come to order arms, without command, upon completion of the marching or facing movement.

3. Order Arms from Trail Arms. The command is "**Order, ARMS.**" On "**ARMS,**" ease your rifle to the position of order by relaxing the grip of your right hand on the upper hand guard. Return your fingers to the position described in paragraph A-2.2.





Figure A-4.--Position of Trail Arms.

A-4. FIX BAYONETS

1. The command is "**Fix, BAYONETS.**" It is given only from order arms.
2. On "**BAYONETS,**" pass the muzzle across your body to the left front and grasp the rifle with your left hand just below the stacking swivel. Then grip the bayonet handle with your right hand. Push the bayonet handle down and forward and draw the bayonet from the scabbard. Fix the bayonet on the rifle without changing your grip on the handle. You may look down at the muzzle while doing so. Then come back to order arms.
3. These movements are not made in cadence, but should be carried out quickly and smartly.

4. Unfit Bayonets

a. The command is **"Unfix, BAYONETS."** It will be given only when at order arms.

b. On **"BAYONETS,"** move the rifle to your left hand as for fix bayonets. Grip the bayonet handle with your right hand and press the catch spring. You may look down while doing this. Raise the bayonet straight up until the handle is a foot above the muzzle. Keep watching the point of the bayonet. Rotate it so the point is down and the back of your hand is toward your body. Replace the bayonet in the scabbard. Then come back to order arms.

c. These movements are not made in cadence, but should be carried out quickly and smartly.

A-5. SLING ARMS

1. The command is **"Sling, ARMS."** It will be given only from order arms. The movements are not executed in cadence.

2. If the sling is not ready, on **"ARMS,"** place your left foot 6 inches to the rear and slightly left of your right heel. At the same time, lift the rifle until the butt is opposite your right hip. Take the rifle at the balance with your left hand, sling to the left. Let your body bend slightly forward. Place the butt in the crotch formed by your hip and right leg. Move the balance of the rifle to the inside of our right elbow and cradle it there so both hands will be free to loosen the sling. Then sling the rifle on your right shoulder in the easiest manner and, except for your right hand, come back to attention. At sling arms, your right hand grips the sling directly in front of your right armpit, the sights point rearward and the barrel straight up.

3. On **"ARMS,"** if the sling is ready, sling the rifle on your right shoulder in the easiest way.

4. This position is used for long parades and marches.

5. Unslung Arms from Sling Arms

a. The command is **"Unsling, ARMS."** It will be given only when at sling arms.

b. On **"ARMS,"** swing the rifle, by the sling, from your shoulder. Catch the rifle at the balance with your left hand. Release the sling and grasp the upper hand guard with your right hand. Lower the rifle to the order. These movements are not done in cadence, but should be executed smartly.

6. Adjust Slings from Order Arms. For the manual to be executed with snap, it is necessary for the rifle sling to be tight. The command is **"Adjust, SLINGS."** It will be given only when at order arms with loose slings. On the command of execution take up the same position used to loosen sling (see paragraph A-5.2 above) and tighten the sling. Then return to order arms. This is done without cadence.

A-6. PORT ARMS FROM ORDER ARMS

1. The command is **"Port, ARMS."** This movement is executed in two counts.

2. On **"ARMS,"** lift the rifle to the left front until your right hand is in front and slightly left of your face and your forearm is parallel to the deck. On the same count take the rifle by the balance with your left hand.

3. On the second count, move your right hand from the upper hand guard to the small of the stock. Grip it palm down. Upon completing the movement, both elbows will be against your sides and your right forearm parallel with the deck. Your left thumb is 4 inches in front of the center of your chest. (See figure A-5.)



a. Count One.



b. Count Two.

Figure A-5.--Port Arms from Order Arms.

A-7. PRESENT ARMS FROM ORDER ARMS

1. The command is **"Present, ARMS."** This movement is executed in two counts and is used as a salute in ceremonies and interior guard duty. When executed from any position of the manual other than order arms the rifle is first brought to port arms upon the command **"Present, ARMS."** Present arms is then executed without loss of cadence.

2. On **"ARMS,"** raise the rifle to a position 4 inches in front of the center of your body, barrel toward you and pointing straight up. At the same time grasp the balance of the piece with your left hand, thumb on the rear hand guard band, fingers joined, sling included in your grip, and elbows against your body. The stacking swivel is at the same level as your eyes.

3. Do the second count, move your right hand to the small of the stock and grasp it. Both elbows are at your sides. (See figure A-6.)



a. Count One.



b. Count Two.

Figure A-6.--Present Arms from Order Arms.

A-8. ORDER ARMS FROM PRESENT AND PORT ARMS

1. The command is "**Order, ARMS.**" It is a three-count movement from either position and will be executed the same way from each.
2. On "**ARMS,**" move your right hand smartly from the small of the stock to the upper hand guard.
3. On the second count, release the balance with your left hand and lower the rifle to a point where the butt is 3 inches from the deck, slightly to the right of your right toe, and the muzzle pointing straight up. While lowering the rifle move your left hand, thumb and fingers are straight and joined, to a point near the stacking swivel. This is merely to steady the piece. Keep your palm facing to the rear so it will not resemble a rifle salute. The forearm and wrist are straight.
4. On the third count, lower the butt gently to the deck and your left hand smartly back to your left side. After this you are at the position of order arms. (See figures A-7 and A-8.)



a. Count One.



b. Count Two.



c. Count Three.

Figure A-7.--Order Arms from Present Arms.



a. Count One.



b. Count Two.



c. Count Three.

Figure A-8.--Order Arms from Port Arms.

A-9. INSPECTION ARMS FROM ORDER ARMS

1. The command is "**Inspection, ARMS.**" It is a five-count movement. When executed from any position of the manual other than order arms the rifle is first brought to port arms upon the command of "**Inspection, ARMS.**" Inspection arms is then executed without loss of cadence. (See figure A-9.)

2. On "**ARMS,**" lift the rifle to the left front until your right hand is in front and slightly left of your face and your forearm is parallel with the deck. At the same time, grasp the piece at the balance with your left hand as for port arms.

3. On the second count, move your right hand from the upper hand guard to the small of the stock. Grip it palm down.

MARINE CORPS DRILL AND CEREMONIES MANUAL

4. On the third count, release the balance with your left hand. Double your fingers into a fist. Place your thumb on the operating rod handle and push smartly to the rear until engaged by the operating rod catch. In doing this don't raise your elbow from your side.

5. On the fourth count move your left hand back to the balance. At the same time look into the receiver by bending your head forward smartly. If the receiver is not empty, empty it.

6. On the fifth count, raise your head back to attention.



a. Count One.



b. Count Two.



c. Count Three.



d. Count Three--Continued.

Figure A-9.--Inspection Arms from Order Arms.



e. Count Four.



f. Count Five.

Figure A-9.--Inspection Arms from Order Arms--Continued.

A-10. PORT ARMS FROM INSPECTION ARMS

1. The command is "**Port, ARMS.**" It is a one count movement and the only command that may be given from inspection arms.
2. On "**Port,**" place the heel edge of your right hand on the operating rod handle and push to the rear. Your fingers should be straight and joined. At the same time, push the follower down with your thumb. Allow the bolt to slide forward about a quarter-inch.
3. On "**ARMS,**" allow the bolt to go home by lifting your hand smartly. Pull the trigger and replace your right hand on the small of the stock. (See figure A-10.)



a. Movement on Port.



b. Movement on Arms.

Figure A-10.--Port Arms from Inspection Arms.

A-11. RIGHT SHOULDER ARMS FROM ORDER ARMS

1. The command is **"Right Shoulder, ARMS."** It is a four-count movement.
2. On **"ARMS,"** lift the rifle across your body. At the same time, take the balance in your left hand.
3. On the second count, release the upper hand guard with your right hand. Take the heel of the butt between the first two fingers of your right hand and close your fingers and thumb around the stock. Your thumb and index fingers touch.
4. On the third count, place the rifle in your right shoulder without changing your grip on the butt. The sights are up; the piece is tilted at an angle of 45 degrees to the deck, and held so it points directly fore and aft. Your right elbow is against your side and your right forearm level with the deck. While placing the rifle on your shoulder, allow your left hand to slide to the small of the stock. Your left hand guides the rifle to your shoulder. The first joint of the your left forefinger touches the rear of the receiver. Your left wrist is straight and left forearm level with the deck. Keep your palm facing to the rear, so it will not resemble a rifle salute.
5. On the fourth count, move your left hand smartly back to your side. (See figure A-11.)



a. Count One.



b. Count Two.

Figure A-11.--Right Shoulder Arms from Order Arms.





c. Count Three



d. Count Four.

Figure A-11.--Right Shoulder Arms from Order Arms--Continued.

A-12. PORT ARMS FROM RIGHT SHOULDER ARMS

1. The command is "**Port, ARMS.**" It is a two-count movement.
2. On "**ARMS,**" jerk the butt down so the rifle will spring from your shoulder. As it leaves your shoulder, twist the butt clockwise one quarter-turn so the rifle will fall in front of your chest, barrel up. Keep your grip on the butt. Raise your left hand smartly to catch the balance 4 inches in front of the center of your chest.
3. On the second count, move your right hand to the small of the stock. (See figure A-12.)



a. Start.



b. Count One.



c. Count Two.

Figure A-12.--Port Arms from Right Shoulder Arms.

A-13. ORDER ARMS FROM RIGHT SHOULDER ARMS

1. The command is **"Order, ARMS."** It is executed in four counts.
2. At **"ARMS,"** remove the rifle from your shoulder in the same manner as described for port arms from right shoulder arms. (See paragraph A-12.2.)
3. On the second count, remove your right hand from the butt and smartly grasp the upper hand guard. Keep your elbow up and your forearm level.
4. On the third count, release the balance with your left hand and lower the rifle to a point where the butt is 3 inches from the deck, slightly to the right of your right toe, and the muzzle pointing straight up. While lowering the rifle move your left hand, thumb and fingers straight and joined to a point near the stacking swivel. This is merely to steady the piece. Keep your palm facing the rear, so it will not resemble a rifle salute. The forearm and wrist are straight.
5. On the fourth count, lower the butt gently to the deck and move your left hand smartly back to your left side. After this you are at the position of order arms. (See figure A-13.)



a. Count One.



b. Count Two.

Figure A-13.--Order Arms from Right Shoulder Arms.



c. Count Three.

d. Count Four.

Figure A-13.--Order Arms from Right Shoulder Arms--Continued.

A-14. RIGHT SHOULDER ARMS FROM PORT ARMS

1. The command is **"Right Shoulder, ARMS."** It is executed in three counts.
2. On **"ARMS,"** release the small of the stock and grip the heel of the butt between the first two fingers of your right hand. Close your thumb and fingers around the stock. Your thumb and index finger touch.
3. On the second count, place the rifle on your right shoulder without changing your grip on the butt. The sights are up; the piece is tilted at an angle of 45 degrees to the deck, and held so it points directly fore and aft. Your right elbow is against your side and your right forearm level with the deck. While placing the rifle on your shoulder, allow your left hand to slide to the small of the stock. Your left hand guides the rifle to your shoulder. The first joint of the your left forefinger touches the rear of the receiver. Your left wrist is straight and left forearm level with the deck. Keep your palm facing to the rear, so it will not resemble a rifle salute.
3. On the third count, move your left hand smartly back to your side. (See figure A-14.)



a. Start.



b. Count One.



c. Count Two.



d. Count Three.

Figure A-14.--Right Shoulder Arms from Port Arms.

A-15. LEFT SHOULDER ARMS FROM ORDER ARMS

1. The command is **"Left Shoulder, ARMS."** It is a four-count movement.
2. On **"ARMS,"** carry the rifle across your body with your right hand. At the same time, take the balance in your left hand.
3. On the second count, release the upper hand guard and grip the small of the stock with your right hand.
4. On the third count, release the balance with your left hand and place the rifle on your left shoulder with your right hand. At the same time take the heel of the butt between the first two fingers of your left hand. Close your left hand. Close your left thumb and fingers around the stock. Your thumb and index finger touch. The piece is at a 45-degree angle to the deck, and the sights up. Keep the rifle pointing directly fore and aft. Your left elbow is against your side, your left forearm level with the deck.
5. On the fourth count, move your right hand smartly back to your side.

A-16. PORT ARMS FROM LEFT SHOULDER ARMS

1. The command is **"Port, ARMS."** It is executed in two counts.
2. On **"ARMS,"** grip the small of the stock with your right hand.
3. On the second count, release the butt with your left hand. At the same time, move the rifle across your body with your right hand and grip the balance with your left. The rifle's and your position are the same as described in paragraph A-12.2. (See figure A-15.)



a. Start.



b. Count One.



c. Count Two.

Figure A-15.--Port Arms from Left Shoulder Arms.

A-17. ORDER ARMS FROM LEFT SHOULDER ARMS

1. The command is "**Order, ARMS.**" This is a five-count movement.
2. On "**ARMS,**" grip the small of the stock with your right hand.
3. On the second count, release the butt with your left hand. At the same time, move the rifle across your body with your right hand and grip the balance with your left. The rifle is now at the position of port arms.
4. On the third count, move your right hand to the upper hand guard, with your forearm level with the deck.
5. On the fourth count, release the balance with your left hand. Lower the rifle to a position in which the butt is 3 inches from the deck, slightly to the right of your right toe, and the muzzle straight up. While lowering the rifle move your left hand, thumb and fingers straight and joined, to a point near the stacking swivel. This is merely to steady the piece. Keep your palm facing the rear and your forearm and wrist straight.
6. On the fifth count, ease the rifle to the deck and move your left hand smartly to your side.

A-18. LEFT SHOULDER ARMS FROM PORT ARMS

1. The command is "**Left Shoulder, ARMS.**" It is executed in two counts.
2. On "**ARMS,**" release the balance with your left hand. Place the rifle on your left shoulder with your right hand. The barrel should point upward, tilted at an angle of 45 degrees to the deck. At the same time, take the heel of the butt between the first two fingers of your left hand. Wrap your thumb and fingers around the stock. Your index finger and thumb touch. Keep your left elbow against your side. Keep you left forearm level with the deck.
3. On the second count move your right hand smartly back to your right side.

A-19. RESTS WITH THE RIFLE

1. Parade Rest from Order Arms. The command is "**Parade, REST.**" It is executed in one count. It may be given only from order arms. On "**REST,**" move your left foot smartly 12 inches to the left. Keep your legs straight so your weight rests equally on both feet. Keep the butt of the rifle on the deck, toe online with the front of your right shoe. Slide your right hand upward, re-grasping the upper hand guard just below the stacking swivel. Fingers joined and curled around touching the thumb. Straighten your right arm directly to the front so that the muzzle points forward and up. Place your left hand behind you, just below your belt. Your fingers should be straight and joined your palm flat and facing rear. (See figure A-16.) Parade rest will also be assumed on the preparatory command to "**ATTENTION,**" if not already at parade rest. Parade rest is assumed as described herein except if at sling arms, the rifle remains slung; if at unsling arms, sling arms first; if at stack arms, assume parade rest without taking arms.
2. At Ease. The command is "**AT EASE.**" It is a one-count movement. It may be given only when halted at attention at order arms, sling arms or unsling arms,

or stack arms. After the command **"AT EASE,"** you may move your left leg, but must keep your right in place. The rifle is held as in parade rest, but with a relaxed arm, when executed from order arms or unsling arms. You may move, but must not talk.

3. Rest. The command is **"REST."** It may be given only when halted at attention at order arms, sling or unsling arms, or stack arms, and is executed in one count. At the command **"REST,"** keep your right foot in place. Your rifle is held as in parade rest, but with a relaxed arm when executed from order arms or unsling arms. If at sling arms, the rifle may be unslung. You may move and talk.

4. Fall Out from Attention. The command is **"FALL OUT."** It may be given only when halted at attention with your rifle at order, port, stack, or unsling arms. On the command **"FALL OUT,"** leave you place in ranks, but remain in the immediate vicinity unless otherwise instructed.



a. Front View.



b. Side View.

Figure A-16.--Parade Rest with the Rifle.

A-20. ATTENTION FROM REST POSITIONS

1. The command is **"Squad (Platoon, or Company), ATTENTION."**

a. On **"Squad (Platoon or Company),"** come to parade rest as described in paragraph A-19.1.

b. On **"ATTENTION,"** come to order arms in one count, except if at sling arms, come to attention at sling arms; if at stack arms, come to attention.

c. From Fall Out. The command is **"FALL IN."** On the command **"FALL IN,"** go back to your place in ranks and come to attention at order arms or unsling arms. If your rifle is stacked, come to attention.

A-21. RIFLE SALUTES

1. Rifle Salute at Right Shoulder Arms. This is a one-count movement, executed on each of two sets of commands "**Rifle, SALUTE**" and "**Ready, TWO.**" It cannot be executed at left shoulder arms.

a. On "**SALUTE,**" move your left hand smartly to the small of the stock. Keep your left forearm level with the deck, palm down, your thumb and fingers straight and joined. The first joint of your forefinger touches the rear of the receiver. (See figure A-17.) When not in ranks, turn your head and eyes toward the person or colors saluted.

b. On "**TWO,**" move your left hand smartly back to your side.



Figure A-17.--Rifle Salute at Right Shoulder Arms.

2. Rifle Salute at Order or Trail Arms. These are one-count movements executed on each of two sets of commands "**Rifle, SALUTE**" and "**Ready, TWO.**"

a. On "**SALUTE,**" move your left hand smartly to your right side, palm down, thumb and fingers straight and joined. The first joint of your forefinger touches the barrel between the stacking swivel and the bayonet lug. (See figure A-18.) When not in ranks, turn your head and eyes toward the person or colors saluted.

b. On "**TWO,**" move your left hand smartly back to your side.





a. Rifle Salute at Order Arms.



b. Rifle Salute at Trail Arms.

Figure A-18.--Rifle Salute at Order or Trail Arms.

3. Hand Salute at Sling Arms. This is executed in the same manner as a hand salute without arms, except your left hand must hold the rifle sling to steady it. As you salute, move your left hand smartly toward your right shoulder. Grip the sling in front of your right shoulder. When the salute is finished, re-grasp the sling with your right hand. If the rifle is slung on the left shoulder, the hand salute is rendered in the normal manner.

A-22 TO STACK ARMS

1. Members of the squad stack arms from their positions in line at normal or close interval. Squad members numbered 3, 7, and 11 make the stacks except when there is no one to their left. In squads larger than 14 men, additional stackmen are designated. In squads so armed that it is not feasible for numbers 3, 7, and 11 to make the stacks, other squad members may be designated as stackmen. The command is **"Stack, ARMS."**

2. At the command **"ARMS,"** the man on the left of the stackman grips his/her rifle by the upper hand guard, raises it, with the muzzle straight up, until his/her right arm is level with the deck. The Marine passes it to the stackman, who grips it with the left hand at the upper hand guard just below the stacking swivel. (See figure A-18a.)

3. The stackman places the butt of the left rifle between his/her feet, with the barrel to the front, muzzle tilted forward. The Marine raises the stacking swivel of the left rifle with his/her left thumb and forefinger. Then the Marine swings the butt of his/her own rifle 2 feet in front and 6 inches to the right of his/her right toe. The Marine then shifts his/her right hand to the stacking swivel, which the Marine engages with that of the left rifle. (See figure A-18b.)

4. The member on the right of the stackman grips his rifle with his/her right hand at the small of the stock, his/her left hand near the stacking swivel. Without moving his right foot, the Marine steps to the left front and carries his/her rifle well forward, barrel up. With the forefinger of his/her left hand, the Marine hooks his stacking swivel to the free hook of the center rifle's stacking swivel. Then the Marine rotates his/her rifle so the barrel rests in the angle formed by the other two rifles. (See figure A-18c.) The Marine pulls the butt toward him/her until the stack is tight and then lowers the butt to the deck. The Marine then resumes the position of attention. (See figure A-18d.) Figure A-18e shows details of the stacking swivels at stack arms.

5. Other rifles are passed to the nearest stack on the right. When passing extra weapons to the stack, the right hand grips the upper hand guard and the left hand grips the balance. The muzzles of these weapons point straight up while they are being passed to the stack. They are laid on the stack by the stackman, sights inboard, and tilted so they remain in place.



Figure A-18a.--Stack Arms, Passing the Left Rifle.



Figure A-18b.--Stack Arms, Placing the Left Rifle.



Figure A-18c.--Stack Arms, Placing the Right Rifle.



Figure A-18d.--Stack Arms, Stack Complete.



Figure A-18e.--Close Up of Stacking Swivels.

A-23. TO TAKE ARMS

1. The squad, in line behind the stacks, takes arms at the command **"Take, ARMS."**
2. At the command **"ARMS,"** the extra weapons are passed back. Weapons are held as when passed to the stack. As members receive their weapon, they resume order arms.

3. When extra weapons have been passed, the stackman grips his/her rifle and the rifle of the stackman on his/her left. The member on the right of the stackman steps to the left front as in stacking, takes his/her rifle, and resumes order arms.

4. The stackman then disengages the two remaining rifles. The Marine passes the left rifle back to the member on his/her left. The member on the stackman's left grips his/her rifle at the upper hand guard and resumes order arms. Then the stackman resumes order arms.

#### A-24. LOADING AND CEREMONIAL FIRING OF THE RIFLE

##### 1. General Rules

a. For ceremonial firing, only the front rank of units larger than a squad executes the loading and firing.

b. Rifles are loaded while locked.

c. Except during the actual firing, loaded rifles are kept locked without command until "**UNLOAD**" or "**Inspection, ARMS**" is ordered.

##### 2. To Load

a. The unit being at attention in any formation the command is "**With Blank Cartridges, LOAD.**" The movements are executed quickly and smartly, but not in cadence.

b. Each front rank rifleman faces half right and places his/her right foot 12 inches to the rear. The legs are kept straight, so the weight of the body rests equally on both feet.

c. The rifle is raised with the right hand and grasped at the balance with the left. The right hand is then moved to the small of the stock. The rifle is now at the position of port arms.

d. The operating rod handle is pulled smartly to the rear with the left thumb. (See figures A-19.)

e. A fully loaded (blank) clip is then removed from the cartridge belt and placed in the receiver with the right hand. The rear edge of the right hand is placed against the operating rod handle and the cartridge pressed down against the follower with the right thumb until the follower engages the clip latch. The operating rod handle is released and the thumb lifted to allow the bolt to slide forward. The rear of the operating rod handle is then pushed forward with the heel of the right hand to ensure the proper seating of the bolt.

f. The right hand is then returned to the small of the stock at port arms.

g. For instruction in loading, the command is "**Simulate, LOAD.**" The movements are executed as described in paragraph A-24.2, except that the handling of cartridges is simulated.

h. To use the rifle as a single loader, the procedure is the same except one cartridge is placed in the chamber rather than a clip in the receiver. Instead of depressing the clip against the follower, the follower is directly depressed with the right thumb.



Figure A-19.--Engaging the Operating Rod Handle.

3. To Unload. The command is "**UNLOAD,**" hook the left thumb over the operating rod handle and push it to the rear. Hold the bolt open. Re-grasping the rifle with the left hand, steady the piece by placing the butt on the right hip. Place the right hand over the receiver and release the clip latch with the right thumb. Catch the ejected clip in the right hand and replace it in the belt. After ensuring there is not a round in the chamber, allow the bolt to close. Pull the trigger and bring the piece to the order.

4. To Fire by Volley

a. After the rifles are loaded as prescribed in paragraph A-24.2, the noncommissioned officer in charge of the firing detail orders, "**Ready, Aim, FIRE.**"

b. On "**Ready,**" take the position of load if not already in that position.

c. On "**AIM,**" raise the rifle to a position of 45 degrees from the horizontal, the butt firmly in the right shoulder, the balance resting in the V formed by the thumb and forefinger of the left hand. All fingers of the left hand are extended and joined. The left wrist is straight. The right hand is wrapped around the small of the stock from the right. The right elbow is raised to shoulder height. The right cheek is pressed firmly against the stock (or thumb on top of the stock) as far forward as comfortable. The left eye is closed, the right looking over the rear sight. Press the safety to its unlock position with the right forefinger. (See figure A-20.)

MARINE CORPS DRILL AND CEREMONIES MANUAL

d. On "**FIRE,**" squeeze the trigger quickly and lower the rifle to the position of "**LOAD.**" If the rifle has been loaded with a single round, it is reloaded without command, unless directed otherwise.

e. To continue the firing, the commands are "**Ready, Aim, FIRE.**" Each command is executed as explained above.

f. To cease firing, the command is "**CEASE FIRING.**" On this command the riflemen will know that no more rounds are to be fired. They bring their rifles to the position of load. The command "**UNLOAD**" is then given and executed as explained in paragraph A-24.3.



Figure A-20.--Firing Party at Position of Fire.

MARINE CORPS DRILL AND CEREMONIES MANUAL

APPENDIX B

RIFLE MANUAL FOR THE M14 SERVICE RIFLE

	<u>PARAGRAPGH</u>	<u>PAGE</u>
GENERAL . . . . .	B-1	B-3
RULES FOR RIFLE MANUAL . . . . .	B-2	B-3
ORDER ARMS . . . . .	B-3	B-5
REST POSITIONS WITH THE RIFLE . . . . .	B-4	B-6
TRAIL ARMS FROM ORDER ARMS . . . . .	B-5	B-6
PORT ARMS . . . . .	B-6	B-7
RIGHT SHOULDER ARMS . . . . .	B-7	B-9
LEFT SHOULDER ARMS . . . . .	B-8	B-11
PRESENT ARMS . . . . .	B-9	B-12
INSPECTION ARMS (WITHOUT MAGAZINE) . . . . .	B-10	B-13
INSPECTION ARMS (WITH MAGAZINE) . . . . .	B-11	B-15
RIFLE SALUTES . . . . .	B-12	B-15
SLING AND UNSLING ARMS . . . . .	B-13	B-17
FIX AND UNFIX BAYONETS . . . . .	B-14	B-19
STACK ARMS . . . . .	B-15	B-19
TAKE ARMS . . . . .	B-16	B-25
LOADING AND CEREMONIAL FIRING OF THE M14 RIFLE . . . . .	B-17	B-25

FIGURE

B-1	M14 RIFLE NOMENCLATURE . . . . .	B-3
B-2	RIFLE HELD DIAGONALLY ACROSS THE BODY . . . . .	B-4
B-3	ORDER ARMS . . . . .	B-5
B-4	PARADE REST . . . . .	B-6
B-5	TRAIL ARMS . . . . .	B-7



MARINE CORPS DRILL AND CEREMONIES MANUAL

	<u>PAGE</u>
B-6	PORT ARMS FROM ORDER ARMS . . . . . B-8
B-7	ORDER ARMS FROM PORT ARMS . . . . . B-8
B-8	ORDER ARMS TO RIGHT SHOULDER ARMS . . . . . B-10
B-9	ORDER ARMS TO LEFT SHOULDER ARMS . . . . . B-11
B-10	ORDER ARMS TO PRESENT ARMS . . . . . B-13
B-11	INSPECTION ARMS WITHOUT MAGAZINE . . . . . B-14
B-12	PORT ARMS FROM INSPECTION ARMS WITH AND WITHOUT MAGAZINE . . . . . B-15
B-13	RIFLE SALUTE AT ORDER ARMS AND TRAIL ARMS . . . . . B-16
B-14	RIFLE SALUTE AT RIGHT AND LEFT SHOULDER ARMS . . . . . B-17
B-15	SLING ARMS . . . . . B-18
B-16	RIFLE SALUTE AT SLING ARMS . . . . . B-18
B-17	PREPARE SLING . . . . . B-20
B-18	SLING LOOP . . . . . B-20
B-19	PREPARE THE STACK . . . . . B-21
B-20	PREPARING THE LOOP . . . . . B-21
B-21	STACKING ARMS . . . . . B-22
B-22	FORMING THE STACK . . . . . B-23
B-23	ADJUSTING THE STACK ARMS . . . . . B-24
B-24	STACK ARMS . . . . . B-24
B-25	FIRING PARTY FORMED FOR CEREMONIAL FIRING . . . . . B-26
B-26	RIFLEMEN FACE HALF RIGHT . . . . . B-26
B-27	RIFLEMEN MOVES THE LEFT FOOT 12 INCHES TO THE LEFT. . . . . B-27
B-28	RIFLE TO PORT ARMS . . . . . B-27
B-29	CHAMBERING A ROUND . . . . . B-28
B-30	FIRING PARTY IN POSITION OF AIM AND FIRE . . . . . B-28

## APPENDIX B

## RIFLE MANUAL FOR THE M14 SERVICE RIFLE

B-1. GENERAL

1. This appendix is designed to provide detailed instructions for the manual of arms for the M14 service rifle for those units and organizations that use this weapon for ceremonial purposes.
2. Execute "FALL IN" with the rifle at order arms.
3. Facings, alignments, and short distance marching movements are executed from order arms. Side step, backward march, open and close ranks, and close and extend are short distance movements. Forward march may be given from order arms to march units forward for a short distance. When these movements are commanded while at order arms, it is necessary to come automatically to trail arms on the command of execution for the movement. The rifle is returned to order arms upon halting.
4. Before a command for any marching movement (other than the exceptions stated in c, above) is given to armed troops, they are faced in the direction of march and their weapons brought to right shoulder, port, or sling arms by the appropriate command. After a marching movement has been completed and it is desired to execute a facing movement, the command to order or unsling arms is given, followed by the command for the facing movement.
5. When in a position other than sling arms, the troops must come to port arms for double time. When the troops are in formation, the commander gives the appropriate commands.

B-2. RULES FOR RIFLE MANUAL

1. The term "at the balance" refers to the point on the rifle (Figure B-1) just forward of the magazine well. In this position the little finger of the left hand is placed on the lower band. While this is not the true balance of the rifle, it is used as a reference point for instructional purposes and to facilitate the manipulation of the weapon while performing the manual of arms.

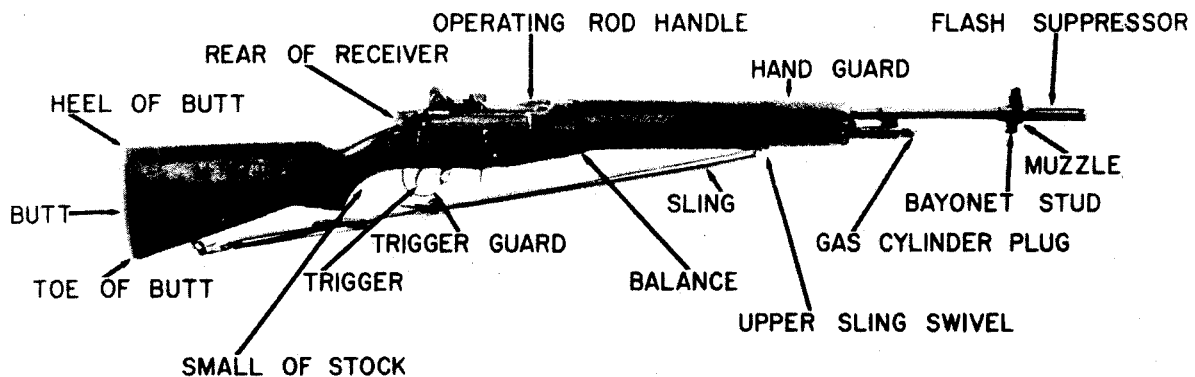

Figure B-1.--M14 Rifle Nomenclature.

2. The position of the rifle known as "diagonally across the body" (Figure B-2) is as follows:

a. The left hand is at the balance, with the thumb and fingers grasping the rifle and sling. To do this, extend and join the fingers so as to form a "U" with the thumb.

b. The barrel is up and at such an angle that it bisects the juncture of the neck and shoulder. The heel of the butt is on line with the right hip (Figure B-2).

c. The rifle is held at a height that allows the right forearm to be horizontal when the small of the stock is grasped with the right hand.

d. The distance of the rifle from the body depends upon the confirmation of the body, but it should be about 4 inches from the belt.



Figure B-2.--Rifle Held Diagonally Across the Body.

3. The cadence for rifle movement is quick time, but in the early stages of instruction the movements are done more slowly until the troops can execute them with precision. They are then practiced until the proper cadence is acquired.

4. The manual for the rifle is executed while standing at the position of attention. To add interest to drill and to lessen fatigue on long marches, movements between right and left shoulder and port arms may be commanded when marching at attention in quick time.

MARINE CORPS DRILL AND CEREMONIES MANUAL

a. To move the rifle from the right shoulder to the left shoulder, "**Left Shoulder, ARMS**" is commanded as the left foot strikes the ground. The first count of this movement is executed as the right foot strikes the ground and the left arm is swinging forward in a natural arc.

b. To move the rifle from the left shoulder to the right shoulder, "**Right Shoulder, ARMS**" is commanded as the right foot strikes the ground. The first count of this movement is executed as the left foot strikes the ground and the right arm is swinging forward in a natural arc.

5. The following positions are commanded from order arms only: inspection arms, trail arms, sling arms, fix and unfix bayonets, and the rest positions at order arms. Port arms is the only command that may be given from inspection arms.

6. The manual of arms with the magazine in the rifle is restricted to inspection arms, port arms, sling and unsling arms, order arms, trail arms, and fix and unfix bayonets.

B-3. ORDER ARMS

1. Order arms is the position of the individual at attention with the rifle. It is assumed on the commands "**ATTENTION**" from any of the rest positions except fallout. Order arms is assumed on the command "**FALL IN,**" and on the command "**Order, ARMS,**" from any position in the manual except inspection arms and sling arms.

2. At order arms the position of attention is maintained except for the right arm and rifle. The rifle butt is placed on the ground with the barrel to the rear and the toe of the butt against and on line with the toe of the right shoe. The upper part of the hand guard is grasped with the right hand in a "V" formed by the fingers and the thumb. The fingers are placed diagonally so the tips of the index finger and the thumb are grasping the sides of the stock; the right arm is kept behind the rifle so the thumb is along the trouser seam (Figure B-3).



a. Front View.



b. Side View.

Figure B-3.--Order Arms.

B-4. REST POSITIONS WITH THE RIFLE

1. Rest positions with the rifle are commanded and executed as without arms, with the following exceptions:
2. On the command "**Parade, REST,**" the left foot is placed 12 inches from and on line with the right foot. The rifle butt is kept against the right foot, the toe of the butt on line with the toe of the shoe. The barrel of the rifle rests against the hip along the seam of the trousers as in the position of attention. The grasp of the rifle is unchanged. The left hand is placed behind the back just below the belt line with the fingers and thumb extended and joined and the palm facing the rear (Figure B-4).
3. On the command "**AT EASE**" or "**REST,**" the right foot remains in place and the rifle is held as in parade rest with the right arm relaxed slightly.
4. When at sling arms, rest positions are commanded and executed as described in paragraph B-13.
5. Armed troops must be at attention at order arms, port arms, stack arms, or unsling arms before "**FALL OUT**" may be given.



a. Front View.



b. Rear View.

Figure B-4.--Parade Rest.

B-5. TRAILS ARMS FROM ORDER ARMS

1. For instructional purposes, the command "**Trail, ARMS**" may be used to teach the position at a halt. At the command "**ARMS,**" the rifle is raised vertically 3 inches off the ground with the wrist straight and the thumb along the seam of the trousers; the grasp of the rifle does not change (Figure B-5). This movement is executed in one count.

2. At the command **"Order, ARMS,"** the rifle is lowered vertically to the position of order arms. For instructional purposes when **"Trail, ARMS"** is commanded, the rifle is held at trail arms until **"Order, ARMS"** is given

3. Trail arms is used for short distance movements. If a marching movement (a side step, back step, or forward march) is ordered while at order arms come to trail arms automatically on the command of execution for the marching movement. The same applies for facing movements, while at order arms. Whenever trail arms is automatically assumed, come to order arms, without command, upon completion of the marching or facing movement.



B-6. PORT ARMS

1. The command is **"Port, ARMS."**

2. This movement is executed in two counts from order arms. At the command **"ARMS,"** the rifle is raised diagonally across the body with the right hand; the left hand grasps the rifle at the balance and holds it so that it is 4 inches from the belt. The right elbow is held down without strain. On the second count, the rifle is re-grasped with the right hand at the small of the stock, fingers and thumb closed around the stock. The right forearm is horizontal and the elbows are against the sides (Figure B-6).

3. From port arms to order arms is a three-count movement. At the command **"ARMS,"** the right hand is moved to re-grasp the upper part of the hand guard without moving the rifle (Figure B-6). On the second count, the left hand is removed from the balance, and the rifle is lowered to the right side with the

right hand until the butt is 3 inches from the ground. The left hand is placed immediately below the bayonet stud, fingers and thumb extended and joined, palm to the rear, to steady the rifle and hold the barrel vertical (Figure B-7). On the third count, the left hand is cut sharply to the side while the rifle is lowered gently to the ground, and the position of order arms is assumed.



a. Start.



b. Count One.



c. Count Two.

Figure B-6.--Port Arms from Order Arms.



a. Start.



b. Count One.

Figure B-7.--Order Arms from Port Arms.



c. Count Two.



d. Count Three.

Figure B-7.--Order Arms from Port Arms.

B-7. RIGHT SHOULDER ARMS

1. The command is **"Right Shoulder, ARMS."**

2. When executed from order arms, right shoulder arms is a four-count movement. At the command **"ARMS,"** the first count of port arms is executed as described in paragraph B-6.2. The right elbow is held down without strain. On the second count, the rifle is re-grasped at the butt with the right hand, the heel of the butt between the first two fingers, and the thumb and fingers closed around the heel with the thumb and forefinger touching (Figure B-8). On the third count the rifle is placed on the right shoulder with the grasp of the right hand unchanged. At the same time, the left hand is moved from the balance to the small of the stock where it is used to guide the rifle to the shoulder. The thumb and fingers are extended and joined with the palm turned toward the body. The first joint of the left forefinger touches the rear of the receiver. The left elbow is kept down. On the fourth count, the left hand is cut smartly back to its position by the side, as at attention.

3. The return to order arms is a four-count movement. On the command **"ARMS,"** the rifle butt is pulled quickly toward the body with the right hand. As the rifle clears the shoulder, the right hand smartly twists the stock 90 degrees in a clockwise direction causing the rifle to be guided diagonally across the body. At the same time the left hand is brought up to catch the rifle at the balance, smartly and audibly. On the second count, the right hand is moved up to grasp the upper part of the hand guard. The third and fourth counts are executed the same as the second and third counts used in executing order arms from port arms (paragraph B-6.3).



MARINE CORPS DRILL AND CEREMONIES MANUAL

4. Right shoulder arms from port arms is a three-count movement. On the first count, the rifle is grasped at the butt with the right hand as in coming to right shoulder from order arms. The last two counts are the same as the last two counts in moving from order to right shoulder arms.

5. Port arms from right shoulder arms is a two-count movement. The first count is the same as the first count from right shoulder to order arms. On the second count, the rifle is re-grasped with the right hand at the small of the stock in the position of port arms.



a. Start.



b. Count One.



c. Count Two.



d. Count Three.



e. Count Four.

Figure B-8.--Order Arms to Right Shoulder Arms.

B-8. LEFT SHOULDER ARMS

1. The command is **"Left Shoulder, ARMS."**

2. To move the rifle to left shoulder arms from the order, the rifle is brought to port arms in the first two counts (Figure B-6). On the third count, the rifle is placed on the left shoulder with the right hand and at the same time the stock of the rifle is driven smartly and audibly into the palm of the left hand as the right arm comes across the body. The butt is grasped with the left hand (Figure B-9). On the fourth count, the right hand is cut smartly to the side as in the position of attention (Figure B-9).

3. Port arms from left shoulder arms is a two-count movement. On the first count, the right hand moves up and across the body and grasps the small of the stock and the right arm is pressed against the body (Figure B-9). On the second count, the rifle is brought from the shoulder and diagonally across the body with the right hand and re-grasped at the balance with the left hand as in the position of port arms (Figure B-6).

4. Order arms or right shoulder arms from left shoulder arms is a five-count movement. On the first two counts, the rifle is brought to port arms. On the last three counts, it is possible to go to order arms or right shoulder arms as described in paragraphs B-6 and B-7.



a. Start.



b. Count One.



c. Count Two.

Figure B-9.--Order Arms to Left Shoulder Arms.



d. Count Three.



e. Count Four.

Figure B-9.--Order Arms to Left Shoulder Arms--Continued.

B-9. PRESENT ARMS

1. The command is **"Present, Arms."**

2. Order arms to present arms is a two-count movement. On the first count, the rifle is raised and carried to the center of the body. It is held vertical, approximately 4 inches from the body with the barrel to the rear. The right elbow is down. The rifle and sling are grasped at the balance with the left hand. The left forearm is horizontal and the elbow is against the side (Figure B-10). On the second count, the right hand re-grasps the rifle at the small of the stock.

3. Order arms from present arms is a three-count movement. On the first count, the rifle is grasped at the upper part of the hand guard with the right hand (Figure B-9) with the right elbow kept down and against the side. The rifle is lowered to the ground with the right hand on counts two and three as in port arms to order arms (Figure B-7).

4. Port arms from present arms is executed in one count. The rifle is raised and twisted with the right hand, the muzzle moves to the left, the rifle is re-grasped at the balance with the left hand (Figure B-6).

5. Present arms is executed in one count. The rifle is lowered and twisted with the right hand while being moved into a vertical position where it is re-grasped at the balance with the left hand.



a. Start.



b. Count One.



c. Count Two.

Figure B-10.--Order Arms to Present Arms.

B-10. INSPECTION ARMS (WITHOUT MAGAZINE)

1. The command is **"Inspection, ARMS."** It is a four-count movement, executed only from order arms.

2. At the command **"ARMS,"** the rifle is raised diagonally across the body with the right hand and is grasped with the left hand at the balance as in the first count of port arms (paragraph B-6.2b). On the second count, the right hand grasp is released and the right hand slides down the rifle with the fingers extended and joined, until the knife-edge of the hand comes in contact with the operating rod handle. At this time, the thumb is on the opposite side of the receiver (Figure B-11). On the third count, the operating rod handle is pressed sharply to the rear and the bolt lock is depressed with the thumb so that the bolt is locked in the rearmost position. At the same time, the head and eyes are lowered to check the receiver (Figure B-11). On the fourth count, having found the receiver empty or having emptied it, the head and eyes are raised to the front and the rifle is re-grasped at the small of the stock as in port arms.

3. **"Port, ARMS"** is the only command that is given from inspection arms. On the preparatory command, the grip on the small of the stock is relaxed to permit the index finger to hook around the operating rod handle, pulling it slightly to the rear so that the bolt lock will be released (Figure B-12). At the command **"ARMS,"** the operating rod handle is released, the trigger pulled, and the small of the stock re-grasped in the position of port arms.

MARINE CORPS DRILL AND CEREMONIES MANUAL



a. Start.



b. Count One.



c. Count Two.



d. Count Three.



e. Count Four.

Figure B-11.--Inspection Arms without Magazine.



a. Movement to **"Port."**



b. Movement to **"ARMS."**

Figure B-12.--Port Arms from Inspection Arms with and without Magazine.

B-11. INSPECTION ARMS WITH THE MAGAZINE

1. The command is **"Inspection, ARMS."** It is a four-count movement with the first two counts the same as inspection arms without the magazine. On the third count, the operating rod handle is pressed sharply to the rear with the knife-edge of the right hand until the bolt engages the magazine follower. At the same time, the head and eyes are lowered to check the receiver. On the fourth count, having found the receiver empty or having emptied it, the head and eyes are raised and the rifle is re-grasped at the small of the stock as in port arms.

2. **"Port, ARMS"** is the only command given from inspection arms. On the preparatory command, the right hand releases the rifle and, with fingers extended and joined, the knife-edge of the hand is pressed against the operating rod handle. After the operating rod handle is pressed slightly to the rear, the thumb is inserted in the rearmost part of the receiver to depress the magazine follower. The bolt is allowed to slide forward slightly. On the command **"ARMS,"** the operating rod handle is released. The right hand is returned to the small of the stock, the trigger pulled, and the position of port arms is assumed.

B-12. RIFLE SALUTE

1. This movement may be executed from order arms, trail arms, right shoulder arms, or left shoulder arms. For instructional purposes, the command **"Rifle, SALUTE"** may be used. The rifle salute is a two-count movement.

2. When at order arms, the left arm moves across the body on the first count, with the forearm and wrist straight, fingers and thumb extended and joined, and palm down. The first joint of the forefinger touches the rifle at a point below the bayonet stud (Figure B-13). If not in the ranks, the head and eyes turn

toward the person or color saluted. On the second count, the left hand is cut smartly to the side and the head and eyes are turned to the front.

3. When saluting at trail arms, the movements are identical with those for saluting at order arms, except that the rifle is held in the trail arms position.

4. At right shoulder arms, the movement is executed by moving the left arm across the chest and touching the first joint of the forefinger to the rear of the receiver. The left elbow is held so that the left forearm is horizontal. Fingers, thumb, and wrist are held as described in b, above. The palm is down (Figure B-14). The second count of the rifle salute at right shoulder arms is executed by cutting the left hand smartly to the side.

5. At left shoulder arms, the movement is executed by moving the right arm across the chest and touching the first joint of the forefinger to the rear of the receiver. The right elbow is held so that the right forearm is horizontal. Fingers, thumb, and wrist are held as described in b, above. The palm is down (Figure B-14). The second count of the rifle salute at left shoulder arms is executed by cutting the right hand smartly to the side.



a. Order Arms Position.



b. Trail Arms Position.

Figure B-13.--Rifle Salute at Order Arms and Trail Arms.



a. Right Shoulder Position.



b. Left Shoulder Position.

Figure B-14.--Rifle Salute at Right and Left Shoulder Arms.

B-13. SLING AND UNSLING ARMS

1. The command is "**Sling, ARMS.**" It will be given only from order arms. The movements are not executed in cadence. If the sling is not adjusted, on "**ARMS,**" the butt of the rifle is placed on the right hip and the rifle cradled in the crook of the right arm (Figure B-15a). The sling is adjusted with both hands and the rifle is then slung over the right shoulder in the most convenient manner. When at sling arms, the sling is grasped with the right hand, keeping the right forearm horizontal and holding the barrel of the rifle vertical (Figure B-15b). If the sling is already adjusted, the rifle is slung in the most convenient manner at the command of execution.

2. The command "**Unslung, ARMS**" is given only from the position of sling arms. At the command of execution, the rifle is unslung and brought to a position of unslung arms by steadying the rifle with the left hand. The positions of order arms and unslung arms are the same except that at unslung arms the sling is loose.

3. So that precise movements of the manual can be executed, the command "**Adjust, SLINGS**" is given. At the command "**SLINGS,**" the sling is tightened while holding the rifle as described in paragraph B-13.1, above.





a. Adjust Sling.



b. Sling Arms.

Figure B-15.--Sling Arms.

4. To salute while at sling arms, on the command of **"ARMS"** of **"Present, ARMS,"** the sling is grasped with the left hand to steady the rifle. The palm of the left hand is to the rear and the forearm is horizontal. At the same time, the sling is released with the right hand and the first count of the hand salute is executed as described in paragraph 2104 (Figure B-16). At the command of **"ARMS"** of **"Order, ARMS,"** the right hand and arm are moved smartly to the side as in the position of attention and then the original position of sling arms is assumed.



Figure B-16.--Rifle Salute at Sling Arms.

5. When at sling arms, parade rest, rest, and at ease are executed as from order arms except that the rifle is held slung with the right hand. When the command **"REST"** is given, the rifle may be unslung. When calling a unit to attention, the position of parade rest at sling arms is assumed on the preparatory command.

B-14. FIX BAYONETS AND UNFIX BAYONETS

1. These movements are not executed in cadence.

2. On the command **"Fix, BAYONETS,"** the muzzle of the rifle is moved across the body and re-grasped with the left hand below the gas cylinder plug. The snap on the scabbard is unfastened and the bayonet is grasped with the right hand. The bayonet is drawn from the scabbard. The point of the bayonet is turned skyward and the bayonet is fixed on the muzzle of the rifle with a downward motion. After the bayonet is fixed, the position of order arms is assumed.

3. The command **"Unfix, BAYONETS"** is given only at the position of order arms.

4. At the command **"BAYONETS."** The rifle is moved to the left hand as when fixing bayonets. The rifleman glances down and grasps the handle of the bayonet with the right hand, the palm toward the body. The bayonet catch spring is pressed with the inside of the forefinger. The bayonet is raised vertically until the handle is approximately a foot above the muzzle of the rifle. Then, keeping the eyes on the point of the bayonet, the rifleman returns the bayonet to the scabbard, reversing the movements of its withdrawal. The snap on the bayonet scabbard is fastened with the left hand and the position of order arms is assumed. The bayonet is carried in the scabbard with the ring to the front.

5. Safety precautions should be observed when fixing bayonets while the rifle is held diagonally across the body with the left hand. Tap the base of the bayonet handle with the heel of the right hand, to make sure that the bayonet is secure. If resistance is met when unfixing the bayonet, thrust the bayonet into the ground, blade facing the right toe. Then press the bayonet release with the toe of the right shoe and remove the rifle from the bayonet. The blade of the bayonet is not touched with the bare hand.

B-15. STACK ARMS

1. The members of the squad stack arms from their position in line at normal interval on the command of **"Stack, ARMS."** After the squad counts off, the commander designates the stackmen by numbers and then gives the command, **"Prepare, SLINGS."**

2. At the command **"SLINGS,"** the stackman places the butt of their rifle on their right hip and cradles it in the crook of their right arm (Figure B-17). The individual then adjusts the sling keeper to form a four-inch loop (a palm's width within the loop) next to the upper sling swivel (Figure B-18). As soon as he/she has prepared the loop, the stackman returns to order arms. After all stackmen are at order arms, the command **"Stack, ARMS"** is given.



Figure B-17.--Prepare Sling.



Figure B-18.--Sling Loop.

3. At the command **"ARMS,"** the stackman places their rifle directly in front of and centered on their body with the sling facing to the front (Figure B-19). The heel of the rifle butt is on the ground on line with the toes of the stackman. The stackman grasps the rifle by the hand guard with their left hand. The first two fingers of the left hand hold the inner part of the loop against the rifle. The individual reaches across the front of the rifle with the right hand, grasps the outer part of the loop, and holds it open for the insertion of the other rifles (Figure B-20). The individual holds the rifle vertical at all times.



Figure B-19.--Prepare the Stack.



Figure B-20.--Preparing the Loop.

4. After the stackman has positioned their rifle, the individuals on their right and left perform the following movements simultaneously:

a. The man on the stackman's left raises and rotates their rifle, sling up, to a horizontal position across their body, muzzle to the right. At the same time, he/she grasps the rifle at the small of the stock with the left hand, palm downward, over the sling. The individual continues to grasp the upper part of the hand guard with their right hand. The individual allows both arms to hang naturally, holding the weapon in a horizontal position (Figure B-21).

b. The man on the stackman's right moves their rifle vertically and across their body with their right hand until their wrist is shoulder high in the center of their body. The individual grasps the rifle with their left hand immediately under the right hand, palm over the sling. The individual then lowers their right hand to the small of the stock, palm facing the sling, and turns the rifle until the sling is up, muzzle to the left, and the rifle is in a horizontal position. The individual lets their arms hang naturally (Figure B-21).



Figure B-21.--Stacking Arms--Continued.

c. As soon as both individuals have completed these movements, each moves their foot that is nearest the stackman 18 inches to the oblique and toward the stackman. In a continuing motion, the man on the stackman's left inserts the muzzle of their rifle into the loop held by the stackman until the bayonet stud protrudes past the far in of the loop (Figure B-22). The individual holds their weapon in this position until the man on the stackman's right inserts the muzzle of their rifle through the loop in the same manner. The muzzle of the second rifle is on top.



Figure B-22.--Forming the Stack.

5. When both rifles have been inserted into the loop, the individuals on each side of the stackman swing the butts of their rifles outward and down to the ground until the stack is tight with the rifle butts on line and approximately 2 feet from the base line (Figure B-23).



Figure B-22.--Forming the Stack--Continued.



Figure B-23.--Adjusting the Stack Arms.

6. After necessary adjustments have been made, all three individuals come back to the position of attention (Figure B-24).



Figure B-24.--Stack Arms.

7. Extra rifles are passed to the nearest stack on the right. As each rifle is passed, is grasped at the upper part of the hand guard with the right hand. Then, with the rifle held vertically, it is passed with fully extended arm to the right front. The man on the right grasps the rifle at the balance with their left hand, brings the rifle to the center of their body, and re-grasps it at the upper part of the hand guard with their right hand. This action continues until the stackman receives the rifle and places it on the stack with their right hand as nearly vertical as possible. The individual places the rifle on the stack with the slings away from the stack.

B-16. TAKE ARMS

1. The squad in position, on line behind the stacks, takes arms at the command **"Take, Arms."**
2. At the command **"ARMS,"** the stackman passes each extra rifle towards its bearer. The rifles are handled in the manner described for passing them to the stack (left hand at the balance, right hand at the upper part of the hand guard). As the individuals receive their rifles, they resume the position of order arms.
3. After all extra rifles have been returned, the stackman grasps the base rifle, holding the loop open as in stack arms.
4. The individuals to the right and left of the stackman take one step to their left and right fronts, respectively. They reach down and grasp their rifles, bringing them to the horizontal position. They grasp them as shown in Figure B-22. The man to the right of the stackman frees their rifle from the stack first. Each man returns to order arms after retrieving their rifle. The individual does this by guiding and steadying the rifle with their left hand as in the next to last count of order arms (Figure B-3).
5. The stackman adjusts the sling of their rifle before returning to order arms.

B-17. LOADING AND CEREMONIAL FIRING OF THE M14 RIFLE

1. General

- a. For ceremonial firing of the rifle, only the front rank of units larger than a squad executes the loading and firing of the rifle.
- b. Normally a firing detail will consist of one noncommissioned officer and seven riflemen. When inadequate manpower is available to provide a full firing detail then one noncommissioned officer and at least three riflemen should be provided. The firing detail should be composed of an odd number of riflemen to honor ancient naval superstitions and traditions.
- c. Except during actual firing, loaded rifles are kept on SAFE without command until **"UNLOAD"** or **"Inspection, ARMS"** is ordered.
- d. In order to enhance the appearance of the firing party, magazines with three rounds will be inserted into the rifle out of view of spectators. Two expended cartridges should be placed in the magazine below the three blank cartridges so that adequate tension will be placed on the magazine spring. To insert the magazine, insert the top front first, and pull backwards and upwards



until the magazine latch snaps into position. A round will not be placed in the chamber until the command **"LOAD"** is given.

2. To Load

a. The firing party is formed in line, with the noncommissioned officer in charge 3 paces in front of and 1 pace to the right of the firing party.

b. With the firing party formed and at attention (Figure B-25), the command is **"With Blank Ammunition, LOAD."** The movements are executed quickly and smartly.



Figure B-25.--Firing Party Formed for Ceremonial Firing.

c. On the command **"LOAD,"** members of the firing party execute the following sequence of movements:

- (1) Face half right. (Figure B-26)



Figure B-26. -- Riflemen Face Half Right.

MARINE CORPS DRILL AND CEREMONIES MANUAL

(2) Move the left foot 12 inches to the left (Figure B-27). The legs are kept straight so the weight of the body rests equally on both feet.



Figure B-27.--Riflemen Moves the Left Foot 12 Inches to the Left.

(3) Raise the rifle to port arms. (Figure B-28)



Figure B-28.--Rifle to Port Arms.

(4) The operating rod handle is pulled smartly to the rear with the right thumb and released, thus chambering a round of blank ammunition. The rear of the operating rod handle is then pushed forward with the heel of the right hand to ensure the proper seating of the bolt. (Figure B-29)



Figure B-29.--Chambering a Round.

(5) The right hand is then returned to the small of the stock at port arms.

3. To Fire by Volley

a. After the rifles are loaded as described above, the noncommissioned officer in charge of the firing party orders, "**Ready, Aim, FIRE.**"

b. On "**Ready,**" press the safety to its unlock position with the right forefinger.

c. On "**Aim,**" each rifleman raises the rifle to a position of 45 degrees from the horizontal, places the butt of the rifle firmly in the right shoulder, and rests the balance in the "U" formed by the thumb and forefinger of the left hand. The fingers are extended and joined. The left wrist is straight. The right hand is wrapped around the small of the stock from the right. The right elbow is raised to near shoulder height. Keep eyes open; look over rear sight. (Figure B-30)



Figure B-30. -- Firing Party in Position of Aim and Fire.

d. On **"FIRE,"** squeeze the trigger quickly and lower the rifle to the position of port arms.

e. To continue firing the commands are **"LOAD, Aim, FIRE."**

(1) On **"LOAD,"** each rifleman manually chambers the next round by pulling the operating rod handle smartly to the rear with the right thumb and release it, thus chambering a round of blank ammunition. The rear of the operating rod handle is then pushed forward with the heel of the right hand to ensure the proper seating of the bolt. (Figure B-29)

(2) **"Aim"** and **"FIRE"** are executed as describe above.

(3) After the last round has been fired, rifles are brought to the position of port arms. From this position the noncommissioned officer of the firing party gives the command of **"Present, ARMS."** This movement is executed in 3 steps on the command of execution **"ARMS."**

(a) With the left foot extended, pivot on the heel of the left foot and toe of the right foot, as in the first count of a left face.

(b) Bring the heel of the right foot smartly against the heel of the left foot, completing the left face.

(c) The riflemen then move the rifle to present arms. The noncommissioned officer in charge of the firing party then executes a right face and presents sword.

(4) After the ceremony, (memorial service, funeral, etc.) the firing party is brought to order arms, faced to the right and marched from the site of the ceremony.

#### 4. To Unload

a. The weapons will be unloaded and inspected as soon as possible after leaving the site of the ceremony and out of sight of the spectators, if possible.

b. The command is **"UNLOAD."** It is executed by executing inspection arms with magazine as describe in paragraph B-11.

MARINE CORPS DRILL AND CEREMONIES MANUAL

APPENDIX C

CEREMONIAL PROPERTY

	<u>PARAGRAPH</u>	<u>PAGE</u>
CEREMONIAL PROPERTY . . . . .	C-1	C-1

FIGURE

C-1 CEREMONIAL PROPERTY MATRIX . . . . .		C-3
--	--	-----



MARINE CORPS DRILL AND CEREMONIES MANUAL

APPENDIX C

CEREMONIAL PROPERTY

C-1. GENERAL. This Appendix contains a list of ceremonial property that can be procured through the supply system. The below list contains a description and national stock number (NSN) for specific items. In addition MCO P10520.3, provides instructions for ordering colors, guidons, streamers, and other heraldic items. MCO P10520.3 also gives detailed instructions on the type and design of all colors and guidons, as well as identifying types of units that rate these items.

DESCRIPTION	NSN
Flag, National Color, Nylon, no fringe w/rope and tassel	8345 00 656 1451
Flag, National Ensign, Garrison 20'x38'	8345 00 656 1440
Flag, National Ensign, Post 10'x19'	8345 00 656 1438
Flag, National Ensign, Storm 5'x9'6"	8345 00 656 1436
Flag, Organizational, Type III, Class 1, Battle Standard	8354 01 281 5500
Flag, Organizational Standard USMC, Type III, Class 2,	8345 01 268 8226
Flag, Organizational Standard USMCR, Type III, Class 3,	8345 01 268 8227
Guidon, Organizational, Type I, USMC, FMF	8345 00 262 3702
Guidon, Organizational, Type II, USMC, Non-FMF	8345 00 262 3703
Guidon, Organizational, Type III, USMCR	8345 00 262 3701
Dress Guidon, USMC w/gold fringe	8345 00 249 6252
Attachment, Streamer Set, Chrome, 15 Hole	8345 00 082 2328
Attachment, Streamer Set, Chrome, 18 Hole	8345 00 163 1251
Cord and Tassel, Red, White and Blue (for National Colors)	8345 00 262 3723
Cord and Tassel, Scarlet and Gold (for Organizational Colors)	8345 00 298 7270
Flagstaff 9'6", 2 piece w/spearhead	8345 00 214 9123
Flagstaff 8', 2 piece w/spearhead	8345 00 214 9125
Spear Head, Guidon	8345 00 386 3780
Connector, Spearhead	8345 00 386 3779
Ferrule, Guidon	8345 00 377 6787
Case, Flag, Plastic, Internment	8345 00 782 3010
Case, Flag, 70"x7"	8345 00 178 8492
Case, Flag, 54"x7"	8345 00 178 8495
Sling, Flagstaff, White Webbing	8345 00 059 7995
Sling, Flagstaff, White Leather	8345 00 291 1670
Sling, Flagstaff, Green Webbing	8345 00 250 0919
Flag, POW 4'x6'	8345 01 452 6283
Flag, POW 3'x5'	8345 01 452 8114
Flag, POW 2'x3'	8345 01 452 8111
Sword NCO, w/scabbard 26"	8465 01 249 8373
Sword NCO, w/scabbard 28"	8465 00 965 1675
Sword NCO, w/scabbard 30"	8465 00 965 1676
Sword NCO, w/scabbard 32"	8465 00 965 1677
Sword NCO, w/scabbard 34"	8465 0 965 1678
Sword NCO, w/scabbard 36"	8465 00 965 1679
Frog, NCO Sword, White Leather	8465 00 307 7768

Figure C-1.--Ceremonial Property Matrix.

MARINE CORPS DRILL AND CEREMONIES MANUAL

DESCRIPTION	NSN
Frog, NCO Sword, Black Leather	8465 00 965 1674
Morning Knot, Sword	8455 00 387 0955
Morning Band, Black	8455 00 252 7325
Buckle, Service Belt, Black Leather	8315 00 664 9127
Service Belt, Black Leather 30"	8465 00 924 7942
Service Belt, Black Leather 32"	8465 00 924 7943
Service Belt, Black Leather 34"	8465 00 924 7944
Service Belt, Black Leather 36"	8465 00 924 7945
Service Belt, Black Leather 38"	8465 00 924 7946
Service Belt, Black Leather 40"	8465 00 924 7947
Service Belt, Black Leather 42"	8465 00 924 7948
Service Belt, Black Leather 44"	8465 00 924 7949
Service Belt, Black Leather 46"	8465 00 924 7950
Service Belt, Black Leather 48"	8465 00 924 7951

Figure C-1.--Ceremonial Property Matrix--Continued.

Note: The use of the metal flagstaff, 9 feet 6 inches is only authorized for use by Marine Barracks, Washington, DC.



MARINE CORPS DRILL AND CEREMONIES MANUAL

APPENDIX D

HISTORY, CUSTOMS AND COURTESIES, AND TRADITIONS OF THE MESS NIGHT

	<u>PARAGRAPH</u>	<u>PAGE</u>
HISTORY AND TRADITIONS . . . . .	D-1	D-3
OFFICERS OF THE MESS . . . . .	D-2	D-5
UNIFORM . . . . .	D-3	D-7
GUESTS . . . . .	D-4	D-8
INVITATIONS . . . . .	D-5	D-8
PROCEDURES . . . . .	D-6	D-9
TOASTS . . . . .	D-7	D-22
CHECKLISTS . . . . .	D-8	D-27
GEAR LIST . . . . .	D-9	D-29
VARIATIONS . . . . .	D-10	D-29

FIGURE

D-1	SAMPLE SEATING DIAGRAM . . . . .	D-13
D-2	FALLEN COMRADES TABLE DIAGRAM . . . . .	D-26
D-3	FALLEN COMRADES TABLE, FIELD MESS NIGHT DIAGRAM. . . . .	D-30



# MARINE CORPS DRILL AND CEREMONIES MANUAL

## APPENDIX D

### HISTORY, CUSTOMS AND COURTESIES, AND TRADITIONS OF THE MESS NIGHT

#### D-1. HISTORY AND TRADITIONS

"Devotion to the Marine Corps and its traditions begets equal earnestness and devotion from all." Gallantry and comradeship-in-arms have enabled our small Corps to build a name for itself that is known throughout the world, feared by our enemies, and respected by every military service in existence. This name was not easily won and we of the Corps should not allow ourselves to forget how it was accomplished, nor should we allow others to forget it. It is not intended that we should advertise our war record, nor that we should even mention it; but to maintain our name we must conduct ourselves at all times in a manner befitting our traditions.

The maintenance of traditional discipline, gallantry, and love of the Corps is our duty. It is our further duty to see that the same high standard of respect and prestige is not only maintained, but also further strengthened. These standards must be passed on to the future Marines who will take their place among the ranks of the Corps' leadership, if they are to look with pride on our accomplishments. The mess night is an element in fostering such standards.

In times past the mess served three functions. It was the home for bachelor officers or enlisted Marines, a club for the married ones, and the center of social life of a post or station. The formality of a mess night reflects the same spirit of dignity as the home and each Marine should conduct themselves with that thought in mind.

The traditions of formal military banquets to celebrate victories, dates to the Roman Legions. In the Sixth Century, the Knights of the Round Table had similar gatherings. The term dining-in derives from the Viking tradition of celebrating great battles and feats of heroes by formal ceremony. This tradition spread to the monasteries and early-day universities, and then to the military when the officer's mess was established. Many of the customs employed in our current mess night come to us from the officer's messes of the Royal Marines and the Regimental messes of the British Army. This is not at all surprising when we consider that in the formative period of our country, the majority of our military leaders acquired what little background and training they possessed from service with either British regulars or Colonial militia in the French and Indian Wars. When our forefathers were faced with the task of establishing their own permanent military organization it was only natural that they should borrow from the British system with which they were familiar. Throughout the years, various changes in format have been effected both by practicality and the unique character of our Corps.

In the U.S. Armed Forces, mess nights date back to the Army's regimental messes of pre-World War I days and to the days of the wine mess in the wardroom afloat, which ended abruptly in 1914 when Secretary Josephus Daniels imposed prohibition on the Navy.

Formal dinners in wardrooms afloat and messes are among the finest tradition of military institutions. The history of the Navy and Marine Corps are replete with examples of such occasions, undoubtedly a carryover from the British practice of formal gatherings in an atmosphere of dignity, which they felt contributed to the unity and esprit of an organization.

## MARINE CORPS DRILL AND CEREMONIES MANUAL

Similarly, this reasoning gave impetus to many such occasions beginning in the highly patriotic era of the early 1800's.

In 1816, a dinner was given in honor of Commodore Stephen Decatur and Captain Charles Stewart as reported by the *National Intelligencer* in these words: "The company sat down to dinner at five o'clock and spent the evening with the purest harmony and good humor. After the cloth was removed, many toasts were drunk, accompanied with highly patriotic songs and music by the Marine Band."

The same newspaper reported a dinner on July 4, 1816, as "a large party of gentlemen assembled to celebrate the glorious festival of the anniversary of American Independence...Accompanied with songs and music from the Marine Band, and announced by repeated discharges of artillery, many toasts were drunk." Some have suggested that this is the origin of "having a shot."

Similar affairs were noted for many years thereafter, always with Marine Officers, Marine Artillery, and the Marine Band in attendance. However, these dinners are not traditional Marine Corps Mess Nights, as we know them today, although they contributed much of the fostering influence.

The only significant mess nights during the 19th century, which were sponsored by the Corps of officers, were at the Old Center House, Marine Barracks, Washington, which must have seen some good-humored evenings in the old days. The *Evening Star* of Washington, DC on February 16, 1908, printed a large photograph of the Old Center House (then torn down) with the following caption: "Tales are told of nights of revelry, when the wine flowed and souls of great men, freed from the cares of state, allowed their wit and spirit to soar unhampered while gracing the Officer's Mess beneath the beams of the old house. The rafters which once rang with the laughter of Presidents now lie in grim disorder." Fortunately, this tradition is carried on and each summer or early fall, Marine Barracks, Washington, Center House Mess is honored by the Commandant at a Mess Night

Aside from the tales and traditions of miscellaneous special dinners, the traditions of Mess Nights, as we know them, come from the 4th Marine Regiment, then stationed in Shanghai. The Regimental swimming coach, Captain Lemeul Shepard, was invited to the Mess of the 2nd Battalion, Scots Guards. His commanding officer, Colonel Davis, was so impressed that, soon thereafter, the first Marine Corps Mess Night was held in 1928.

Probably the first formal Mess Night to be held after World War II was conducted in 1953 by officers of the 3rd Regimental Combat Team, then in Japan, under the command of Colonel Robert H. Williams. The occasion for this particular evening was the visit made to the area by General Lemeul Shepard, then Commandant of the Marine Corps. Thereafter, members of the 3rd Marines continued to enjoy Mess Nights. When Colonel Williams was transferred to Marine Barracks, 8th and I, the custom was reestablished at that Command.

The Staff Noncommissioned Officer Mess Night tradition was begun at the Staff Noncommissioned Officer Academy in 1971, when the academy was first established. Today the custom of the Mess Night has become firmly rooted in the traditions of the Marine Corps. It is taught and practiced at both officer and enlisted professional military education schools as well as by various size units throughout the Marine Corps.

## MARINE CORPS DRILL AND CEREMONIES MANUAL

As we all know, customs and traditions are perpetuated from one generation to the next. The "*Esprit de Corps*" of every Marine has been brought about by their ever-present feeling of pride, not only in his unit, but also in themselves; to emulate, but not bask in the glory of, the worthy deeds of his past. It is with this feeling that we carry on the custom of the mess night.

So as the Revolutionary War recruiting poster of the Continental Marines stated, (the latter portion of which is often used as the final "bottoms-up" toast of the evening to the Corps)...Take courage then seize the fortune that awaits you, repair to the Marine Rendezvous where in a flowing bowl of punch, and three times three, you shall drink, "Long Live the United States and success to the Marines."

### D-2. OFFICERS OF THE MESS

1. There are two functional officers of the mess: the President and Vice President. They are designated to oversee the planning and execution of the event. Together they establish a chronological checklist of tasks to be accomplished prior to the mess night, as well as the conduct of the mess night itself.

a. The President of the Mess is normally the commanding officer or the senior Marine within the mess. The President's duties include:

(1) The President sets the date and place for the mess night, coordinates the activities of all representatives, ensuring all deadlines are set and met.

(2) The President appoints the Vice President and various committees.

(3) Select and send invitation to the guest of honor 3 to 4 weeks in advance of mess night.

(4) At least two weeks prior to mess night ensures invitations to guests are prepared and delivered.

(5) Designates escorts for the guest of honor and all other guests. (Each guest will be assigned an escort.)

(6) Arranges for the chaplain for the invocation.

(7) Prepares introductory comments and an introduction of the Guest of Honor.

(8) Establish a seating diagram using paragraph D-6.9 as guidance.

(9) Select an appropriate gift for the guest of honor. This gift should have no real value other than as a memento, appropriately engraved and signifying the occasion. The gift should never be a personal item, but rather one that can become a treasure only to the guest of honor.

(10) Brief the field music on when to sound all music for the mess night. If the band is not available assign an individual to play taped music.

## MARINE CORPS DRILL AND CEREMONIES MANUAL

(11) Ensure all members of the mess are informed as to how to conduct themselves during the mess night, ensures the members designated to give toasts rehearse their toasts well before the actual event, and schedules a rehearsal of the mess night with all hands present.

(12) During the mess night the President greets all guests and members of the Mess before dinner.

(13) Introduces the guest of honor and other honored guests of the Mess.

(14) Maintains the decorum of the Mess, controls and levies fines, and in addition to proposing toasts, recognizes members and guests who wish to propose toasts.

(15) Ensure a letter of appreciation is sent to the honored guest after the mess night.

b. The Vice President (Mr. or Madam Vice) may be appointed but is normally the junior officer or noncommissioned officer within the organization or unit. The Vice President's duties include:

(1) The planning, coordination, and execution of the entire mess night. The Marine is advised and assisted by the Mess President and committee members and makes progress reports to the Mess President.

(2) Undertake all preliminary arrangements, e.g., guest list, seating diagram, menu, catering, music, decorations, etc.

(3) Collect funds from all mess night members and conducts all financial transactions.

(4) Prepares a letter of invitation to the guest of honor and obtains a biographical sketch.

(5) Provides the Mess with an exact number of participants and guests.

(6) Coordinates with the treasurer of the mess night and treasurer of the banquet facility to complete all financial transactions.

(7) Ensures all monies collected are recorded and copies of receipts are kept.

(8) Responsible for the conduct of the mess night and ensures the sequence of events is kept on track. Accompanies the chief steward when parading the beef, delivering wine and rum punch to the head table. Pours the wine and rum punch and brings forth the smoking lamp.

c. The success of the mess night depends on the Vice President.

2. Mess Committee. Depending on the size of the mess night, committees may be formed to assist the President and Vice President in the planning, preparation and conduct of the mess night. The President selects other members of the Mess as committee chairmen. Examples of committees are:

a. Seating Committee - Place cards, seating, centerpiece, silver, crystal and china.

## MARINE CORPS DRILL AND CEREMONIES MANUAL

b. Decorations Committee - Menu, serving time, public address system, awards, flags, trophies, photographer, payment of mess and bar charges.

c. Protocol Committee - Prepares invitations, provides biographies of the guest of honor and distinguished guests, briefs escorts, prepares the program, and thank you letters for after the event.

3. Members of the Mess. A mess night is a formal dinner attended by all hands assigned to a unit's mess. It is customary for members not desiring to attend such affairs to request a leave of absence, in writing or person, addressed to the President of the Mess.

4. Escorts. Members of the mess may be assigned duties as escorts. Prior to the mess night the escort should contact the invited guest and inform them of mess customs, dress, sequence of events, and any other pertinent information. If necessary the escort also arranges for transportation and quarters for the guest when needed. During the mess night the escort's responsibilities include offering the guest a beverage, introducing them to other members of the mess, and showing them their proper place at the table. Escorts will not make their guests feel uncomfortable or "captive" by introducing themselves as an assigned escort. Three or four members of the mess should attend guests at all times, rotating among the membership to allow the guests to meet and speak with a majority of the mess.

5. Duty Officer. In certain units, the duty officers attend the dinner wearing swords. This custom was adopted from the Worcestershire Regiment, whose Captain of the Week traditionally wears their sword in the mess as a token of the time when all officers remained under arms during meals. This practice is said to have begun when the Regiment was stationed in North America in 1746. The Regiment employed a number of reputedly loyal Indians. For this reason, the officers did not take the trouble to protect themselves against the Indians, who suddenly attacked them one evening, ruining dinner and causing numerous casualties. If such is a unit tradition, the uniform will be dress blue/blue white with sword. These officers will refrain from imbibing and will return to their posts immediately following dinner.

### D-3. UNIFORM

1. The uniform for a mess night should be prescribed as the best uniform that the respective Marine possesses. The uniform should always be prescribed as Evening Dress and each Marine must ensure that he/she is in their best uniform, although it may not necessarily be the uniform their commanding officer is wearing. For example, for company-grade officers this would mean the dress blue/blue white "A" uniform. For those enlisted members not in possession of the dress blue uniform then the service "A" uniform would be appropriate.

2. If the correct term for the uniform of a sister service is not known, use the phrase "Evening Dress." Do not use "Full Dress", as this may imply daytime uniform with sword, which is not desired.

3. For civilians, "Military Evening Dress, if convenient" may be requested if it is known the civilian is a retired or reserve service member. This often adds color to the mess, particularly abroad. If attending in civilian attire, Black Tie with miniature medals or dark suit with large medals is common and proper. The invitation automatically implies at least a dinner jacket. If a tailcoat is

desired, "Full Dress" should be stated and "Orders and Decorations" is noted under the dress requirement. Miniature medals, neck ribbons, and sashes are appropriate on civilian dress at formal military functions. Do not use the expression "Black Tie" or "White Tie" on the invitations.

D-4. GUESTS. There are three types of guests:

1. Official Guests. Official guests are guests of the mess as a whole and the members of the mess share their expenses. Their number should be limited. It might be noted that the selection of guests for mess night should be chosen with discretion. It is better to have no guest, than to honor someone who does not rate such a distinction. As a general guide, it would be considered improper to honor an officer junior to the senior officer of the mess unless the junior officer had in some way distinguished himself or was a foreign national. It is always proper to honor a prominent public figure.

2. Guest of Honor. The guest of honor is an official guest of special distinction. "When the guest of honor is a very high ranking official, it is customary to offer him/her the option of a date and to consult their staff concerning the guest list and general arrangements. After these preliminaries, a regular "invitation with 'To Remind' written on it instead of RSVP should be sent to the guest of honor."

3. Personal Guests. Personal guests are also guests the mess, but their expenses are absorbed by the individual who invited them. If the guest is a serving officer, he/she should "be junior to the commanding officer. The President of the Mess will specify the number of guests each member may entertain.

D-5. INVITATIONS

1. When you are invited to a social gathering, notification will come in the form of an invitation. The invitation will contain all the information you will need to prepare yourself for the occasion. The information placed on the invitation is to assist you and the host and will include the following basic information.

a. Who is Giving the Affair

(1) Avoid all but accepted abbreviations. Rank, titles and names are written in full.

(2) If the invitation is extended to a person primarily because he/she is the incumbent of a certain billet, his/her command title is used. However, if such is not the case, the invitation should specify their rank and last name only.

(3) On invitations to official guests, the proper phrase is "the honor of your company." Too personal guests "the pleasure of your company."

b. The Location, Date and Time. The date and hour are spelled out, but only the day and month are capitalized. Military time is not used.

c. The Type of Attire. In the lower left-hand comer indicate the desired uniform to be worn. Include other service and civilian equivalents if guests other than Marines are in attendance.



## MARINE CORPS DRILL AND CEREMONIES MANUAL

d. The phrase "RSVP," "Regrets," or "To Remind."

(1) RSVP is French for "Respondes S'il Vous Plait," or "Please Reply." In the lower left hand corner, "R.S.V.P." with periods and only one capital letter, is written. (R.S.V.P. with periods and all capital letters is also correct.) The reply should be made within 48 hours of receipt of invitation. Underneath the "RSVP" will be the person to whom the response is to be sent with a phone number, address or an e-mail address for you to use for your reply. It is normally used for very formal occasions. For very formal or large functions, there may be a card included in the invitation for you to use to send back with your reply. This phrase is used on the invitation and is the host/hostess way of ensuring the correct amount of food, cocktails and seating is available. You must reply if you are accepting the invitation or if you are declining the invitation.

(2) Regrets. The phrase "Regrets' or "Regrets Only" is used only if you do not plan to attend. A simply apology stating that you cannot attend will do. If you do not reply, then the host will assume that you are coming and will plan accordingly.

(3) To Remind. This is sent as reminder to someone that has been orally invited to a function. For example, if the host calls you on the phone and invites you to a function, and you accept, he/she may send you a "To Remind" invitation so that you do not forget. If you decline on the phone he/she will not send you the invitation.

(4) Withdrawing Acceptances. On rare occasions, a guest who has accepted an invitation must withdraw the acceptance. The only acceptable reasons for withdrawing an acceptance are due to official duties, severe illness, unforeseen but mandatory out of town absence, or the recent death of a close relative. When you must withdraw an acceptance you must notify the host immediately so he/she can make adjustments to their plans. This should be done orally and then followed up with a written notification.

2. Fifteen to thirty days before the dinner, invitations are extended to all guests that are not members of the mess. Invitations may be partly engraved on unit stationary or entirely handwritten and should follow the standard pattern. *The Service Etiquette* provides detailed guidance on preparing invitations.

### D-6. PROCEDURES

1. Planning. Well in advance of the anticipated date, the command will designate the Officers of the Mess. The President will inform the Vice President that he/she desires to have a mess night on a certain night. The President should also inform the Vice President of his wishes concerning guests. The Vice President is completely responsible for the proper organization and execution of the mess night. The Vice President must ascertain the number of Marines who are to attend, and ensure that sufficient space is available at the mess for both cocktails and dinner.

a. Day of the Dinner. Mr. Vice should be at the mess early on the morning of the dinner with a working party available to assist him/her in the final preparations. The unit silver or trophies should be displayed, together with the appropriate flags, decorations, paintings or photographs. The national and organizational colors are placed behind the President's chair per chapter 7 of this Manual. At organizational mess nights, unit guidons can be banked behind the head table with good effect. Ensure the table is set in the proper manner and that place cards for individuals are checked for accuracy against the seating arrangement posted.

## MARINE CORPS DRILL AND CEREMONIES MANUAL

b. Evening of the Dinner. The President and Vice President must be at the mess at least 30 minutes prior to the commencement of the dinner, cocktails being a part of the dinner. They must make a final check of all details and ensure that nothing has been left to change. By this time, the punch bowl is positioned, and the rum punch is mixed.

2. Facilities. For many details, the Vice President must confer with the manager of the mess. Sufficient time should be allocated for advance planning and to make coordination with supporting organizations. Reservations should be completed at least 2 weeks prior to the date, giving the mess manager the opportunity to complete their planning and to prepare the desired menu. One week prior to the dinner, the Vice President should check again with the mess manager and give him/her a final figure on those attending, approve the menu for the evening, ensuring that the proper wines are available in sufficient quantity, and ensure that the waiters to be used are familiar with the serving procedure for a formal dinner.

3. Menu. There are normally 4 to 6 courses at formal dinner. Roast prime rib of beef with Yorkshire pudding is the traditional entree at a mess dinner. The courses will normally consist of the following although substitution is allowed.

Appetizer -Shrimp, clams, oysters, herring juice, melon, etc.

Soup -Consommé.

Fish -As desired.

Entree -Roast, vegetables, rolls.

Salad -As desired

Dessert -As desired. A savory, rather than a sweet dessert is served, as the latter spoils the taste of the port. Coffee is served with dessert.

4. Décor. Two weeks prior to the event, the Vice President should assemble all the unit silver to be displayed and see to its proper cleaning. The Vice President will need to obtain cooperation of unit commanders to see that the silver is made available to him/her and that sufficient personnel to assist in the work are assigned. The Vice President should make an inspection of all colors and standards to be used and see to their cleaning and pressing. The unit silver should be assembled, together with the appropriate flags, decorations, paintings or photographs well in advance. It should be no problem to procure pictures or relics of the unit for display, if only the time and energy are expended. The table should be set in the proper manner, with a place card for each individual. The seating arrangement will need to be posted in the lounge, in order that each Marine will know where he/she is to be seated. The punch bowl for the traditional toast is to be inspected and its position designated for best service.

5. Music. If at all possible, music should be performed by the unit's own band. Requirements may range from two drums and four fifes for announcing dinner and playing tributes during toasts, to a small orchestra section for playing dinner music and after dinner music, to an entire marching band for complete entertainment. However, in our modern world of electronics, it is expedient to have a sound system on a good quality public address system serve as a substitute if the band is not available. Regardless of what is used, the music must be chosen with care. As a general rule, selections are chosen to alternate between martial music and classical or semi-classical selections. If contemporary music is played care must be taken to play a variety as not all tastes are the same. The Vice President should meet with the bandmaster and approve the proposed music selections

## MARINE CORPS DRILL AND CEREMONIES MANUAL

for the evening, ensuring that the band is thoroughly familiar with the "National Anthem" or unit marches of the guests who are to be toasted. The Vice President should be particularly cautious in the case of foreign nationals, as occasionally they have several unit marches, only one of which is proper for playing in conjunction with toast. The Vice President may check with the guests' mess secretary or aide-de-camp for advice as appropriate. The following are the standard mess night music.

- a. "*Dinner Chimes*" or "*First Call (First Sergeant Call)*" 15 minutes prior to the start of dinner.
- b. "*Officers Call*" or "*Mess Call*" ("Mess Call" may be substituted a for enlisted mess night) 5 minutes prior to the start of dinner.
- c. "*Sea Soldier*" or "*March On*" for the march on of the mess members.
- d. "*Semper Fidelis*" for the march on of the head table.
- e. "*Roast Beef of Old England*" for the march on of the beef.
- f. If foreign officers or guests are present their national anthem is played when their head of state is toasted.
- g. "*National Anthem*" for the toast to the Commander and Chief.
- h. "*Anchors Away*" for the toast to the Navy. If toasts are made to the other services then their service song is played at this time.
- i. If foreign service members are guests and their service is toasted then appropriate music will be played.
- j. "*Taps*" during the Fallen Comrade toast.
- k. "*Marine's Hymn*" during the toast to the Corps. Traditionally, all the members of the mess sing all three versus of the Marine's Hymn.

6. Cocktails. The room set aside for cocktails should command a great deal of the Vice President's attention, as this is where his/her brother and sister Marines and guests will receive their first impression of the evening's festivities. The room should if possible, be small enough to lend itself to an atmosphere of intimacy yet not so small that the guests feel they are crowded. It is better to have a room too large than one too small. Subdued lighting should illuminate the room.

a. Cocktail Hour. Members of the mess are expected to attend cocktail hour, whether they chose to imbibe or not. Each member of the mess should arrive at the appointed place for cocktails 5 minutes before opening time. The cocktail hour is primarily designed to establish social rapport and to afford an opportunity to meet the guests. The cocktail hour should last not longer than 45 minutes. There will be sufficient time after dinner to completely satisfy all thirst and members should, therefore, avoid excessive drinking prior to dinner. It is customary that each Marine upon entering presents himself/herself to the President of the Mess. A simple "Good evening sir/ma'am" will suffice. To take a drink or to smoke prior to doing this is bad manners. In addition, the younger Marines should take this occasion to pay their respects informally to the senior members; this is proper and much appreciated by the older Marines. At sometime during the cocktail hour, every member should make it a point to introduce themselves to each of the guests.

## MARINE CORPS DRILL AND CEREMONIES MANUAL

b. It is the specific duty of the President to greet each guest as that person arrives at the mess. The guest of honor is usually the last to arrive and is greeted immediately by the Vice President. The guest of honor is introduced to the President, and subsequently to the mess. There should be three or four members attending each guest at all times prior to and after the dinner. Members should rotate between peer groups and guests to assure that each guest has an opportunity to converse with three or four different members at all times. As a member of the mess, you are a host and should act accordingly. During the cocktail hour there should be no formal "Hors D'oeuvres", however, it is quite proper to have several plates of peanuts, potato chips, crackers, and pretzels placed about the room. At this time suitable music should be played. Everyone attending must be in the cocktail lounge at least 10 minutes prior to the hour fixed for dinner. Be sure to locate your seating assignment prior to the Call to Dinner. Do not spoil your evening by becoming intoxicated at this time.

7. Call to Dinner Depending on local ground rules, members and guests may proceed informally to their places; or where more formality is the custom, each marches into the wardroom at designated times. The usual entrance for large assemblies is for the membership to be in place within the wardroom and the Officers of the Mess march in procession, escorting the honored guests. The signal for dinner will be the playing of "Officers Call," (or "Mess Call" for enlisted mess nights) followed by "SeaSoldiers" or "March On." As soon as the music starts, all hands not seated at the head table should dispose of their drinks and cigarettes, and proceed informally (but orderly) into the wardroom to their seating locations and stand behind their chairs. The musicians will start playing in the wardroom, march through the cocktail lounge back into the wardroom, around the table and return to the cocktail lounge where they will halt. By the time the music has returned to the cocktail lounge, all hands, except those to be seated at the head table, will have retired to the wardroom and found their respective places at the table. They will stand quietly behind their chairs. There should be no delay moving into the wardroom and the path of the musicians should never be restricted. At this time there will be no one in the cocktail lounge except those to be seated at the head table and the musicians. The President will form those to be seated at the head table in the order in which they are to march into the wardroom. The President with the honored guest on his/her right, followed by the next senior officer and the next senior honored guest, etc., followed by the remaining officers in order of seniority, prepare to enter the wardroom (as an option the head table may March on in the order in which they are to be seated). When all the guests are ready to enter the wardroom, the President will inform the bandmaster that he/she may proceed with the ceremony. The musicians will strike up "*Semper Fidelis*", enter the wardroom, march around the table and halt. Once the music has entered the wardroom and reached the far end of that room, the President will lead the head table guests to their seats. As soon as the last member to enter has stopped and turned to face his place setting, the music will cease playing, execute the prescribed facing movements and march out of the wardroom to a single drumbeat. The President will initiate the formal opening of the mess (by offering grace). Once the head table has entered the wardroom, no one will be allowed to enter the mess without permission from the President. The proper sequence to enter after this point is to address "Mr./Madam President" and wait to be acknowledged. Express your regrets and ask to join your place in the mess. Conversely, once seated, no one may leave the wardroom without permission of the President. Regardless of the degree of formality in the entrance, drinks or cigarettes will not be carried into the wardroom. It is not proper to have alcohol on the table during grace.

8. Grace. As soon as the musicians have left the wardroom, the President will rap with a spoon or gavel as the signal for order and attention. All hands will be standing. The President says in all audible but not loud voice. "Ladies and gentlemen the grace." The chaplain, or in his/her absence the President or the Vice President will then say grace. Immediately following the grace all hands will be instructed to take their seats. Often there is a short concluding grace after dinner, before the port is served. Do not create a sermon out of grace. A story is told about the officer who was informed he/she would have to act as President of the mess, due to the absence of the commanding officer, and also render a short grace. Whereupon the officer intoned, "The commanding officer is not here. Thank God." A more appropriate grace might be: "Father, we thank you for the blessing you have given us today and throughout our lives. We are especially thankful for the privilege of gathering here in this mess tonight, honoring the traditions and esprit so deeply rooted within our beloved Corps. We invoke your blessing on this assembly, the meal we are about to enjoy, and the fellowship that will follow. Amen."

9. Seating Arrangement. The tables may be arranged in any order that suits the particular circumstances, the only rule being that no one should be seated across the head table. Members of the mess, with certain reservations, are normally seated according to seniority, from the head table down. Seating will, as far as practical, prevent members of the same organization sitting together (to aid in the prevention of "talking shop"). Typical diagrams may be a "T", a "U", an "E", or a "Multiple Line." (See figures D-1.) If more than one spur extends from the head table, they should be disjoined to permit passage of the stewards between the spurs and head table. The senior honored guest sits on the right side of the President, the next senior guest on the left. The remaining guests are interspersed throughout the mess to ensure their being well entertained by members. The Vice President is seated at the foot of the table or separate table opposite the head table at large mess nights. Do not mis-seat the honored guest.

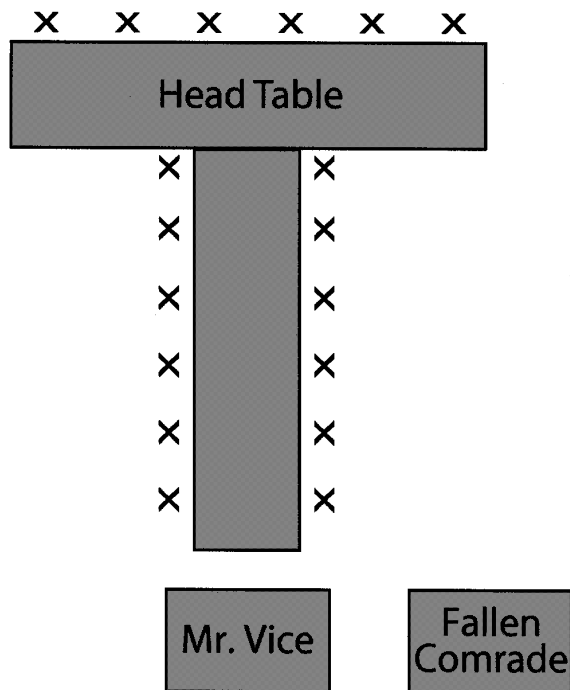

a. "T" Seating Layout.

Figure D-1.--Sample Seating Diagram.

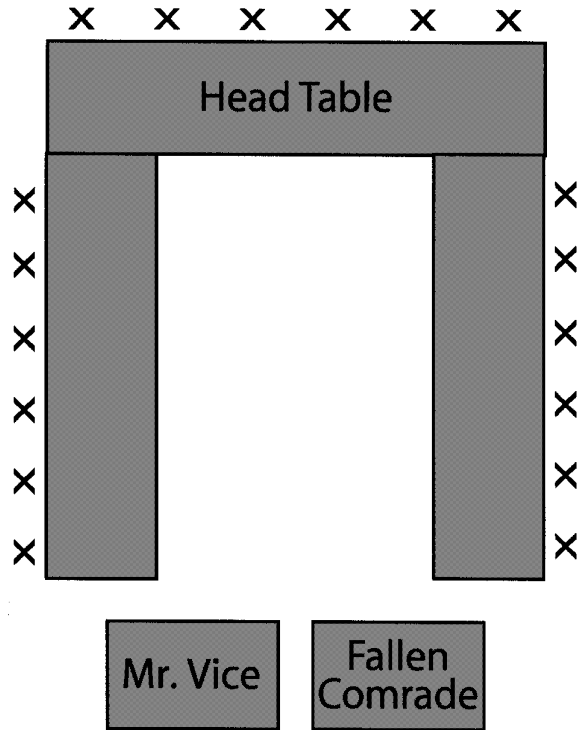

b. "U" Seating Layout.

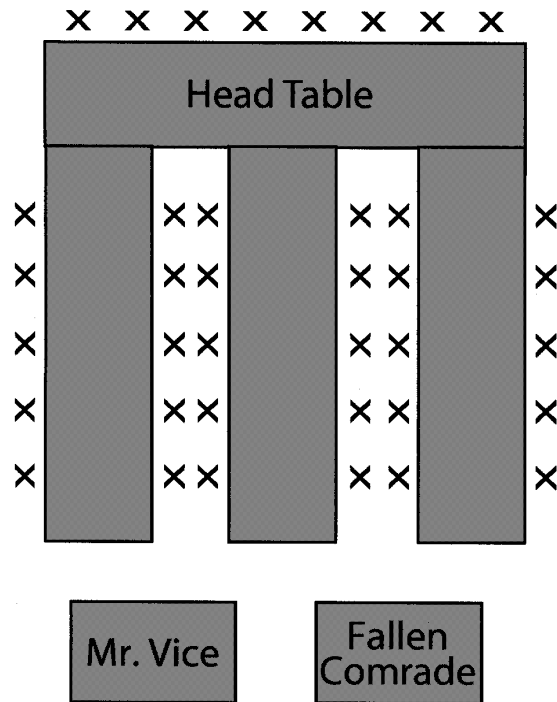

c. "E" Seating Layout.

Figure D-1.--Sample Seating Diagram--Continued.

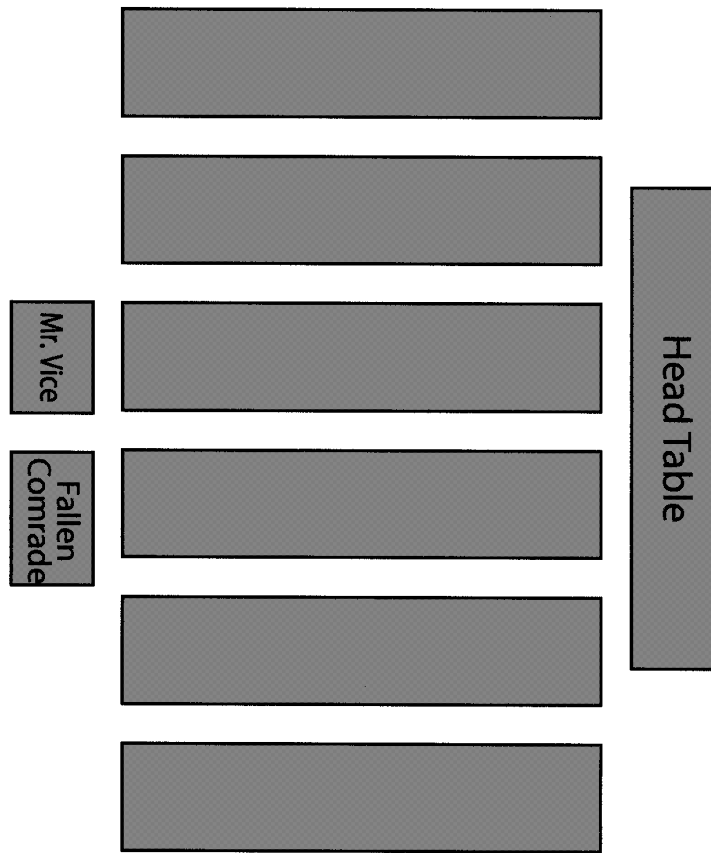

d. "Multiple Line" Seating Layout.

Figure D-1.--Sample Seating Diagrams--Continued.

10. Table Setting. A formal table setting using a unit's silver, crystal, and china can make a handsome picture. A lay plate is in the center, partially covered by a neatly folded napkin on top of which lies the place card. To its left, working from the outside toward the plate, will be the forks in the order of use--fish, meat, and salad, the latter properly being eaten after the main entree. To its right, working from the outside toward the plate, will be the fruit and soup spoons, then the knives in order of use--fish, meat, and salad. However, the oyster fork is always outboard on the right side. Above the knives will be the crystal. Again working from the outside toward the center, in order of use--a sherry glass for white wine, one for red wine, a Claret glass for port (found only at stag dinners), and a goblet for water. Thus, by merely proceeding in order, the wrong equipment cannot be used. After each course, a well-trained steward will remove all extra silver and glass, again aiding the choice of the proper utensil at the proper time. The dessert implements are normally found on the dessert plate. If not, they will be innermost utensils of their kind. Butter plates are not used on formal setting. The center of the table is decorated with flowers or unit silver. Candelabra will furnish all light. Nuts, celery, etc. are placed in appropriate dishes and removed at the proper time. Ashtrays and cigarette containers will be conspicuously absent.

11. Dinner. The backbone of a good dinner is amicable and friendly conversation. Each Marine is not only expected, but also encouraged to enjoy himself to the utmost during the dinner hour. As Marines, jokes that are off-color or which may be detrimental to the guests are forbidden. It is beneath the dignity of a Marine to make any comment that possibly might offend anyone present over dinner. During the dinner, members must refrain from loud and boisterous conversation. Exuberance of spirit is more properly accepted after completion of the meal, when all guests and members join at the bar. It must be kept in mind that there are guests present who are judging the whole Marine Corps by the manner in which the members conduct themselves. Women, politics, and religion are not discussed in the wardroom or mess. Customarily, a woman's name is not mentioned in the wardroom or mess unless she is a celebrity. There are normally 4 to 6 courses at a formal dinner. The service will be conducted by two stewards in a counter clockwise fashion commencing with the honored guest and the officer to the right of the President. In that way the official hosts, the President and the Vice President are served last. The head steward will clear the table when each person at the table has finished his course. Therefore, dinner should be consumed at normal speed. Stewards should not be disciplined during dinner. Refer complaints to the Vice President. Traditionally, when roast beef is the entree, the President will command "Chief steward bring forth the beef for my inspection" and the chief steward will ceremoniously roll on the beef escorted by the Vice President while music sounds "the Roast Beef of Old England." He halts behind the President, cuts him a small but choice piece and lays it before the President on a plate. The President will taste the beef and declare "I find this beef to be tasty and fit for human consumption." Serving then commences.

12. Wines. Good wine is as much a part of a formal dinner as the entree. There has evolved over the years a rule of thumb that white wine is to be served with white courses, fish and fowl, and red wine with blood meats. Champagne may be used any time. Sherry, sometimes served with soup, is more often omitted. White and sparkling wines are served chilled. Red wine is offered at room temperature, however it is well to remember that this infers a temperature of 58-60F. Port, an after dinner brandy, is served for all toasts except to the Corps, for which a rum punch is used. This punch was initially reported in a recruiting poster that appeared in Philadelphia in January 1776, which ordered the recruit upon enlistment to: "REPAIR TO THE MARINE RENDEZVOUS, WHERE IN A FLOWING BOWL OF PUNCH, AND THREE TIMES THREE, YOU SHALL DRINK, LONG LIVE THE UNITED STATES AND SUCCESS TO THE MARINES." To make the traditional 1775 Rum Punch; mix 4 parts dark rum, 2 parts lime juice, 1 part maple syrup, and add a small amount of grenadine to taste. Ice generously. The wine, in decanters if available, is served by stewards or placed on the table and passed by the members. At the end of a course that calls for wine, the steward will properly remove your glass. Do not stop him, even though your glass may be full. It is also improper to turn a glass upside down on the table. Should a member not desire wine, he/she may place his card over the glass, inform the steward that he does not wish wine, or simply allow him/her to pour the glass and do not drink it. The steward will remove the glass at the proper time, full or not. However, glasses must be charged with port for toasts and at least raised to the lips. Not to do so would be an insult to the person toasted. Appropriate wines with each course stimulates the palate and accentuates the meal, however, remember that a chilled rose goes with all food combinations, has a light, pleasant taste, and is inexpensive (in other words, you don't have to be a wine snob to rum a good mess night).



13. Smoking. Following dessert and coffee, the entire table will be cleared except for the port glasses. Port will be called for and all glasses should be charged as soon as possible. Do not drink it yet. Ashtrays and cigarettes or cigars will be placed on the tables. Do not smoke yet. Following the loyalty toast, the President announces "Ladies and gentlemen, the smoking lamp is lighted." Now, and not before, smoking commences. Cigars will be passed. The Vice President will light the smoking lamp, if there is one available and pass it to the President, who lights the honored guests' tobacco. The Smoking Lamp is always announced as being "lighted", not as being lit. When the smoking lamp is lighted and cigars and port are passed around, the President may, at his discretion, send for the bandmaster and offer him/her a drink.

14. Use of the Gavel. The gavel, in possession of the President of the Mess, will be used to signal the members. Three resounding raps require the attention to the President of the members, whether standing or seated. Two raps cause the members to rise, standing in place, and one rap is the signal for the members to take their seats.

15. Applause. Applause or gaining attention from the mess will be accomplished by rapping a spoon against the table. Do not strike the glassware. Follow the example of the President. As guests are introduced, applause is correct and invited as each guest is introduced and at the conclusion of each one's remarks.

16. After Dinner Activities. At some point, the President will signal that dinner is concluded and invite all present for further conviviality by saying, "Ladies and gentlemen, you join me in the bar. "Remember, the members of the mess should wait until the head table and guests have left the wardroom. Then, without undue haste, they also leave the dining area to continue the festivities at the bar. All hands are encouraged to stay, enjoy themselves and partake of refreshments. The remainder of the evening may be spent more or less, as impulse and ingenuity suggest. Singing is always in order and camaraderie is the key to the remainder of the evening. By this time many Marines are often pleasantly surprised to discover how really well they can produce harmony. There are also any number of parlor games and feats of strength that could be planned in good taste. The custom has grown in some messes for the members to join into rough and dangerous games after dinner. This is not only dangerous to the individual, but quite often causes the destruction of mess property. Remember that you are in your dress uniform and even though you may not worry about its care, others do worry about theirs. However, you choose to occupy yourself or whatever hilarity you indulge in, never forget that you are a Marine and represent the Nation's finest. Proper etiquette and decorum dictate that, as the mess is your home, you must remain until all official guests have left. It is also customary not to leave the mess for your quarters until your commanding officer has retired for the evening. The President must remain in the mess until all officers senior to himself/herself have retired for the evening, at which time he may designate the Vice to remain as host until all hands have departed. This is necessary to ensure that all members and guests receive full courtesies of the mess, yet leave promptly at closing time and to see that the unit's decorations are secured after the evening is over. However, a more common practice of departing the bar after a proper and decent interval serves the purpose of the evening much better. If the usual custom is observed, it will place the senior guests and officers in an awkward position. They will feel compelled leave early, even though inclination is to stay on, in order not to inconvenience those who may have important duties the following day and wish to leave at an early hour. Anyone should feel free to leave at any time after the proper interval, and done properly, the guests and officers of the Mess will take it as a kindness.

17. Behavior. Your behavior is just as important as the way you dress. Looking good will not bring you respect if you cannot conduct yourself accordingly. Here is a list of the things you should do and why, and the things you should not do.

a. What You Should Do

(1) Be on Time. One of the most valuable habits you can acquire is that of being on time. It is said that promptness and responsibility go hand in hand.

(2) Receiving Lines. If there is a receiving line, it is a courtesy--and therefore mandatory--that you go through the receiving line.

(3) Table Talk. Loud talk and laughter at the table are disturbing to others. Be careful of controversial or unpleasant subjects, such as politics, religion, or death.

(4) Always stand when being introduced.

(5) Treat self-introduction with care; the impression you give will be the one that is remembered.

(6) Do

(a) Introduce yourself and speak to each guest.

(b) Make head call prior to dinner.

(c) Eat at your own pace. Let the stewards take your plate and glass when attempted.

(d) Remain in the bar after dinner.

b. What You Should Not Do

(1) Public Display of Affection. Entering into any formal gathering accompanied by your date is all the attention you need. Open or extreme displays of affection are not considered appropriate at any formal function, and should be kept at a modest or minimum level. Refrain from any type of groping or lewd gestures at all costs. Remember that you are a Marine officer, staff noncommissioned officer, or noncommissioned officer and a true professional and are expected to carry yourself as such.

(2) Do not drum on a table with your fingers, or tap your feet on the floor. If you do--stop it. Finger or foot tapping draws attention to what you are doing and takes away from what is being said.

(3) Poor grammar, rude or vulgar talk, and the persistent use of improper and uncouth phraseology are representative of careless personal habits.

(4) Don't

(a) Drink too much at the cocktail hour.

(b) Smoke at the table until the "Lamp is Lighted."

MARINE CORPS DRILL AND CEREMONIES MANUAL

- (c) Discuss sex, religion, or politics at dinner.
- (d) Use raucous behavior at the table.
- (e) Do not talk with food in your mouth. Avoid making noises while eating or swallowing and chew with your mouth closed.
- (f) Do not blow on hot liquids to cool them.
- (g) Do not lick your fingers. That is the purpose of having a napkin.
- (h) Never reach for food; ask for it to be passed.
- (i) When finished with the napkin, place it to the left of the plate, not inside of it.
- (j) During cocktail never have both hands full at the same time.
- (k) Always wait for the guest of honor or host/hostess to begin eating first.

18. Rules of the Mess. The following are some time-honored rules of the mess. These can be modified or expanded depending on local custom.

- a. Thou shall be punctual, heavy fines will be levied on all late arrivals.
- b. Thou shall not wear an ill-fitting, ill-prepared, or discolored uniform.
- c. Thou shall not wear clip on ties.
- d. The sounding of "Chimes" is the last opportunity to make thy head call until thy meal is completed.
- e. Thou shall not murder the Queen's English.
- f. Thou shall not use foul language, speak smut tingly, or use loud, obtrusive remarks in any language.
- g. Thou shall not pick thy nose, ears, or buttocks.
- h. Thou shall not fluctuate, lest thou be severely punished.
- i. Thou shall not chew gum.
- j. Thou shall not bring cocktails or other tobacco products in the dining area.
- k. Thou shall sit in thy assigned seat.
- l. Thou shall not rap on glassware for attention.
- m. Thou shall not rearrange the table settings.

MARINE CORPS DRILL AND CEREMONIES MANUAL

- n. Thou shall greet the guest of honor and make every effort to greet all members of the Mess at some point during the evening.
- o. Women, politics, shop, money, and religions shall not be discussed at the Mess. The Commander in Chief's policies will not be discussed.
- p. Thou shall not haggle over thy date of rank.
- q. Thou shall not refuse any course, nor shall you ask for seconds, thy meal shall be consumed as served, and in a manner becoming a lady or gentlemen.
- r. Thou shall not throw food or disgrace the Mess with unruly conduct.
- s. Thy elbows will remain from the table.
- t. Thou shall not turn glasses upside down or refuse any beverage. Members shall not be required to consume alcohol, however all glasses will be filled.
- u. Wine will be passed from right to left.
- v. Thou shall not "bottom up" glasses for every toast, only for the final "Toast to the Corps."
- w. Exclusive of actual emergencies, no member shall leave the dining area until thy head table has exited.
- x. Thy President and the Vice President shall be the only consultants of time during the feast.
- y. Members may request to address thy Mess by standing up at their seat and asking, "Mr./Madam Vice President, (rank and name) request permission to address the mess." The head table is not required to request permission and may address the mess directly.
- z. Thou shall not rise with smoking material in mouth or hand.
- aa. Thou shall not use tobacco products until the smoking lamp is lighted. Only cigars provided to the Mess will be smoked.
- bb. Thou shall not put ashes on the plates, table, or floor. All smoking materials shall be extinguished properly.
- cc. The Vice President will monitor the behavior of the Mess throughout the evening. Upon request of the President, he/she will list any violations of these rules and the President will assign appropriate punishment. Members of the Mess may request to address the Mess in their own defense. All fines will be paid to the Vice President.
- dd. Any member of the Mess addressed directly by the President may respond directly without requesting permission from the Vice President.
- ee. The decisions of the President are final and may not be appealed. The decisions of the Vice President are final and may not be appealed, unless overturned by the President.

MARINE CORPS DRILL AND CEREMONIES MANUAL

ff. Thou shall move to the Mess when it is time and remain standing until seated by the President.

gg. Thou shall keep toasts and comments within the limits of good taste and mutual respect. Degrading or insulting remarks will be frowned upon by the membership. However, good-natured needling is ENCOURAGED. Thou shall not laugh at ridiculously funny comments unless the President shows approval by laughing.

hh. When the Mess adjourns, thou shall rise and wait for the President and guests to leave.

ii. The Mess will not talk to the head table or servers of the mess.

jj. Thou shall not start a course before the President.

kk. Thou shall use proper toasting procedure.

ll. Thou shall ensure that thy glass is always charged while toasting.

mm. Thou shall practice in all toasts unless thyself or the group is honored with a toast.

nn. Thou shall have exact funds for fines.

oo. Thou shall not have a copy of these violations in the Mess.

19. Cost. The cost of a mess night should be prorated by rank. Both the "*Marine Officer's Guide*" and the "*Handbook for Marine Noncommissioned Officers*" contain examples of the Schatzel formula used to calculate prorated costs.

20. Fining. The tradition of fining is a hold over from the days of closed messes when members lived and subsisted in the mess and formal rules for conduct in the mess existed. When the President raps the gavel three times and announces that the floor will be open for fines, you will now have the opportunity to levy charges, on anyone in the Mess except for the members of the head table. You may bring to the attention of the Mess any violations or infractions your fellow Marine may have violated or committed. Be prepared to address the Vice President and the President correctly. Also prepare to be challenged by those accused which, might result in your being fined. Today this tradition is an optional part of the mess night. The President will generate fines for any infractions deemed appropriate. Coins of the realm are designated as United States Dollars (the Vice President will not make change!) However, fines are not required to be monetary in nature. The following guidelines apply when fining:

a. The President is the only person authorized to levy fines.

b. Guests are exempt from fining.

c. Unfounded accusations brought to the attention of the Mess will be grounds for the accuser being fined.

d. If monetary fines are levied they should be a token amount and the procedures agreed upon by all members in advance.

## MARINE CORPS DRILL AND CEREMONIES MANUAL

e. An alternate to monetary fines may be imposed. This includes singing, tests of knowledge and exercises.

f. All monetary fines collected will be dispersed by the Vice President to cover the cost of after dinner drinks or donated as an additional gratuity to the serving staff.

g. While not all inclusive, the following specific infractions that will incur fines are:

(1) Navigational errors (know your place and be in it at the proper time).

(2) Hagglng over dates of rank or precedence numbers.

(3) Excessive grog intake or spilling your drink (alcohol abuse will be dealt with severely).

(4) Food (and drink) is not eligible to log flight time, therefore, do not launch it.

(5) Annoying the President with trivial or unwarranted allegations from the Mess.

(6) Grievous violations of the Mess protocol (uncouth behavior without permission).

21. Addressing the Mess. The following procedures will be used to address the Mess.

a. The Marine will stand at the position of attention and address the Vice President; "Mr./Madam Vice, (Rank & Name) requests permission to address the Mess."

b. The Vice President will address the President; "Mr./Madam President, (Rank & Name) requests permission to address the Mess. (Note: The Vice President has the unconditional option to deny or forward the request.)"

c. When the President grants permission, the Marine will address the President and state the charge.

d. If the nature of the address is to accuse a member of an infraction, the President has the option of allowing accused to respond to accusation. Consider charges only or dismiss accusation and fine accuser.

e. When addressing the Mess, do not break the position of attention without permission. This requires the individual to request permission to move about freely.

### D-7. TOASTS

1. It is appropriate here to mention the term "toast" which is English in origin. The idea is not older than the 17th century and had reference first to the custom of drinking to the ladies. In Stuart times it was the custom to put a piece toast in the wine cup or glass before drinking in the belief that this improved the flavor of the wine. There is an account of a celebrated beauty who, during the

reign of Charles II, was bathing in public when one of her admirers took a glass of water in which she stood and drank her health to the assembled company. The account goes on to say that "there was in the place a gay fellow, half befuddled with drink, who offered to jump in and swore, though he needed no more liquor, he would have the toast." There are four classes of toasts:

- a. Toasts of Protocol. To foreign governments or chiefs of states; toast to the President of the United States.
- b. Official Toasts. To other services, military organizations, government departments, agencies, or institutions.
- c. Traditional Toasts. To Corps and country, toast to battles.
- d. Personal Toasts. To individuals (distinguished guests, members being dined out, etc.)

2. Port is served from decanters and is passed clockwise from the President and Vice President. All toasts are with port except the traditional toast. When all glasses are charged, toasts will begin. The President controls the procedure. The President will call for a toast to the head of state of the senior foreign guest. After a proper interval (usually about 2 minutes), he/she will call for a toast to the head of state of the second senior foreign guest, until the heads of government of all foreign guests or members have been toasted. Many messes add a bright touch to a toast. The President may propose a toast to "The King of the Belgians" and the Vice President replies in French "Le Roi de Belge," this could be an exciting toast in Korean or Chinese. The President then turns to the senior foreign guest and calls him/her by name. The senior foreign guest will stand and propose the toast "Ladies and gentlemen, to the President of the United States" which is not seconded (this is called "*The Loyal Toast*"). The mess rises and the orchestra plays the "*National Anthem*." When the music ends, the mess raises their glasses, respond in unison "The President of the United States," drink, and return to their seats.

3. If foreign guests or members are not present, the President will call for a toast to the President of the United States as the first toast and then light the smoking lamp. The President then proceeds to toast the units represented by the United States service members at the dinner. This follows a short talk by the senior honored guest and introductions or shorter talks by the remaining official guests. The President must tactfully inform each official guest to limit his remarks to not more than 10 minutes. The mess will not rise to applaud speeches, unless exceptionally inspiring, and only on the example of the President or Commanding Officer. After speechmaking, the President may open the floor for toasts from the mess.

4. The procedures for toasting utilize the following sequence. The person making the toast addresses the toast to the Vice President. The Vice President seconds the toast and finally all members of the mess echo the toast. As an example:

**President:** "Mr./Madam Vice, a toast to the President of Tunisia."

**Mr./Madam Vice:** "Ladies and gentlemen (pause while all stand), a toast to the President of Tunisia."

**All:** "The President of Tunisia."

MARINE CORPS DRILL AND CEREMONIES MANUAL

5. The next series of toasts are to the units of the foreign guests or members, called by the President. These are followed by toasts to the units of American Services represented at the dinner, according to seniority of those present, regardless of whether they are members or guests of the mess.

a. **President:** "Mr./Madam Vice, A toast to the United States Navy." **Mr./Madam Vice:** Ladies and Gentlemen, a companion at sea. It is with a great deal of respect and honor that I propose a toast to our sister service, the United States Navy. **All:** "The United States Navy."

b. **President:** "Mr./Madam Vice, A toast to our comrades-in-arms, the U.S. Navy Corpsmen." **Mr./Madam Vice:** Ladies and gentlemen, to those who provide care and comfort on the battlefield. It is with a great deal of respect and honor that I propose a toast to our comrades-in-arms U.S. Navy Corpsmen." **All:** "Navy Corpsmen."

6. Toasts from the mess are given in similar fashion, except for asking permission to toast. A person stands and says "Mr./Madam Vice, a toast." Mr./Madam Vice will acknowledge the toast with "Propose your toast sir" The member or guest says "Mr./Madam Vice, a toast to the Continental Marines, who.." Mr./Madam Vice will stand, raise his/her glass and says "Ladies and gentlemen." All hands will stand with wine glasses in their hands and Mr./Madam Vice will continue "To the Continental Marines." All members raise their glasses, repeat in unison the words of Mr./Madam Vice, drink a portion of their wine, and resume their seats.

7. Some organizations seed the mess to offer historic toasts when the floor is opened, examples of these are:

a. A toast to the Continental Marines who fought for our freedom and liberty. (Mr./Madam Vice responds: The Continental Marines.)

b. A toast to the Marines of the 19th century who fought from the Halls of Montezuma to the Shores of Tripoli. (Mr./Madam Vice responds: The Marines of the 19th century.)

c. A toast to the Marines who fought in World War I from the Argonne Forest to Belleau Wood. (Mr./Madam Vice responds: The Marines of World War I.)

d. A toast to the Marines who fought in the island campaigns of World War II where "Uncommon valor was a common virtue." (Mr./Madam Vice responds: The Marines of World War II.)

e. A toast to the Marines who fought in Korea from Inchon to the Chosin Reservoir (Mr./Madam Vice responds: The Marines of the Korean War.)

f. A toast to the Marines who fought for freedom in Viet Nam (Mr./Madam Vice responds: The Marines of the Viet Nam War.)

g. A toast to the Marines currently forward deployed to the sharp edge of the sword. (Mr./Madam Vice responds: The deployed Marines.)

h. Newer toasts may be added as needed. Such as:

(1) A toast to the Marines in Beirut, who gave their lives defending the sanctity of another nation. (Mr./Madam Vice responds: The Marines of Beirut.)



MARINE CORPS DRILL AND CEREMONIES MANUAL

(2) A toast to the Marines who fought in the Persian Gulf War to liberate a nation from aggression. (Mr./Madam Vice responds: The Marines of the Persian Gulf War.)

8. In place of individual toasts an alternate toast can be inserted at this time to honor all of the battles that Marines have fought in. The President of the Mess makes the following introductory remarks after which selected members of the mess stand in sequence and each announces a battle. They remain standing. A ship's bell is rung once after each battle is announced. After all battles have been announced the members sit.

**President:** "Ladies and gentlemen, it is traditional to pay homage to the valor shown and sacrifices made by Marines who have distinguished themselves throughout history." (A ship's bell is rung one time following each campaign.)

BLADENSBURG  
TRIPOLI  
CHAPULTEPEC  
GUANTANAMO BAY  
MEUSE-ARGONNE  
GUADALCANAL  
TARAWA  
IWO JIMA  
OKINAWA  
INCHON  
CHOSIN RESERVOIR  
KHE SANH  
HUE CITY  
LEBANON  
GRENADA  
PANAMA  
KUWAIT  
SOMALIA

9. A moving toast, often offered by the Guest of Honor just prior to the Traditional Toast, is the fallen comrade toast. It involves staging an empty table, draped in black, in a corner of the wardroom. It should be set with a full dinner setting and prominently display a pair of blank Identification Tags and a Purple Heart Medal (Figure D-2). The toast that is offered describes:

a. "Marines, I too have a toast. I would direct your attention to the table at the rear where a place has been set for those Marines who have gone before us. The military way of life is filled with much symbolism. The table provides a way to tell us that members of our profession, whom we call "brothers", are unable to be with us this evening. It is set for one, yet there are many represented by the single chair. The table is draped in black, symbolizing the color of mourning; the ultimate sacrifice, a table set in honor of our fallen comrades. The single lighted candle reminds us of the flame of eternal life that the memory of our fallen comrades will be with us always. The Purple Heart medal displayed to reflect the infliction of wounds and the ebb of life in battle. The identification tags blank, yet they could bear the name of Marines of every creed and color, and from every state in the Union. The dinner setting inverted, they dine with us in spirit only. Those who have died so that we may live, our former comrades who

have earned the glory and have given to us the respect and pride that we, as Marines, hold so dear." ... (inflection pause)... "Marines and honored guests, let us honor our fellow Marines, who have gone before. Mr./Madam Vice, a toast to all Marines who have died for our beloved Corps."

b. **Mr./Madam Vice:** "Marines a toast." (The entire mess will rise to the position of attention) "To our fallen comrades."

c. **All:** "To our fallen comrades."

d. Taps is played.

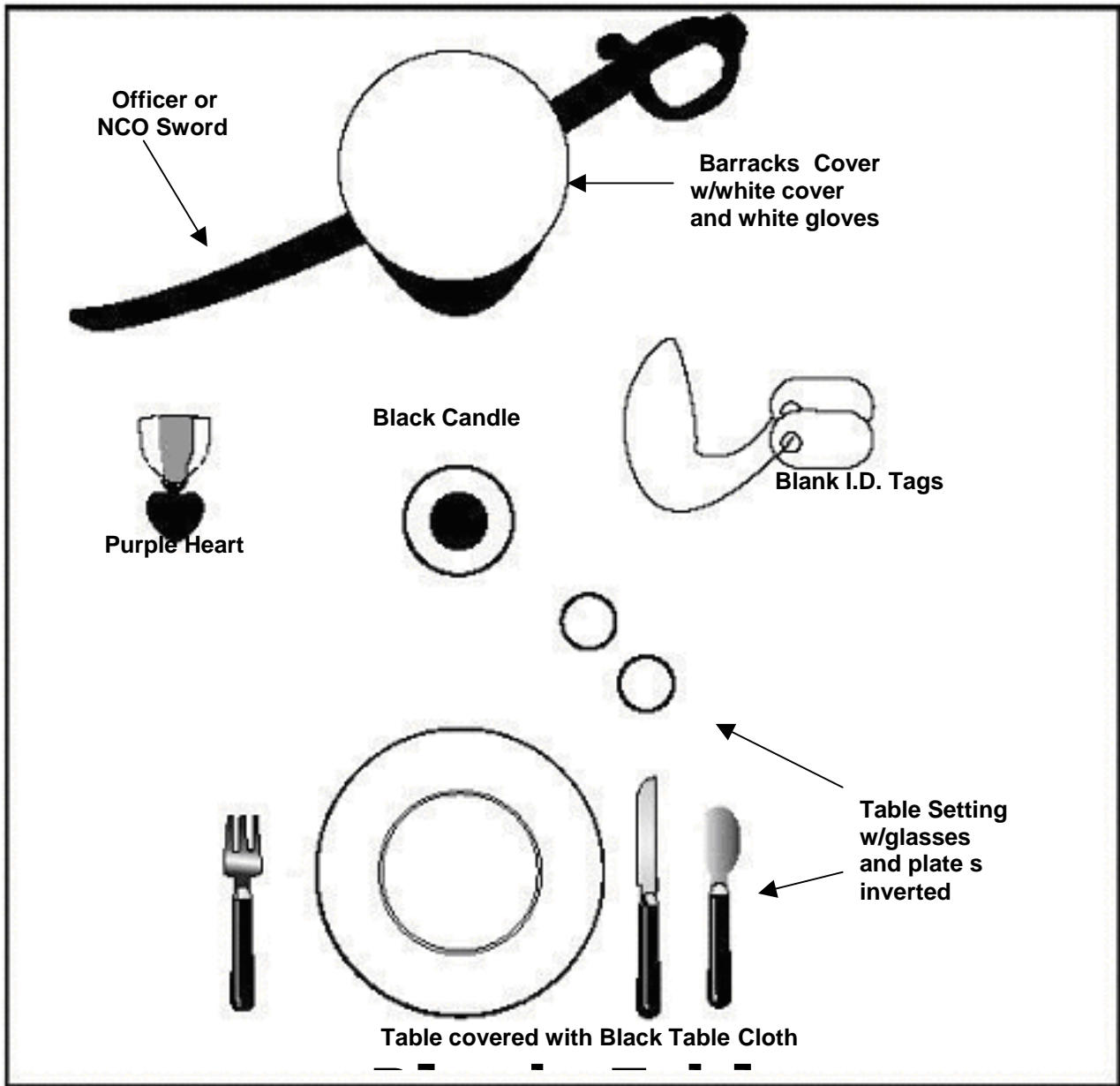

Figure D-2.--Fallen Comrades Table.

MARINE CORPS DRILL AND CEREMONIES MANUAL

10. To conclude the formalities of dinner, the President calls for the toast, "To Corps and country." Mr./Madam Vice fills each cup from the punch bowl at the end of the table starting with the honored guest and ending with the President. At large dinners the Vice fills only the cups of those seated at the head table, the stewards charging the other glasses. The President fills the Mr./Madam Vice's cup who then faces about and seconds the toast.

a. **President:** "In 1776, one of the first recruiting posters ordered recruits upon enlistment, take courage then, seize the fortune that awaits you, repair to the Marine rendezvous, where in a flowing bowl of punch, and three times three you shall drink (pause), long live the United States and success to the Marines. Mr./Madam Vice, a toast to the country and Corps."

b. **Mr./Madam Vice:** "Ladies and Gentlemen, a toast. Long live the United States and success to the Marines!"

c. **All:** "Long live the United States and success to the Marines!"

d. Marines' Hymn is played or sung.

11. From this point, procedures vary with each mess according to the desires of the commanding officer and its own traditions. Usually, the President will offer: "Ladies and gentlemen, will you join me in the bar?" after which all members will stand fast until those seated at the head table have departed the dining room.

12. The following are some general rules for toasting:

a. Do not toast the Commandant.

b. Do not be caught with an uncharged glass.

c. Do not "bottoms-up" your glass on each toast, only on the final traditional toast.

d. Do not stand or drink a toast if you represent the service toasted, except the Traditional Toast.

e. Keep in mind that toasts are offered to institutions, never to persons by proper name.

f. During toasts to battles, individuals who participated in the specific battle will remain seated.

D-8. CHECKLIST.

1. The following is a sample checklist of key events and milestones that occur during the preparation for a mess night.

\_\_\_\_\_ Command selects officers of the mess and assigns committee members.

\_\_\_\_\_ Select honored guest, make initial correspondence to his office to ensure that the date of the mess night fits into his schedule.

\_\_\_\_\_ Prepare for the honored guest and obtain his biographical sketch.

MARINE CORPS DRILL AND CEREMONIES MANUAL

- \_\_\_\_\_ Send letters to support agencies to reserve facilities, arrange for field music, arrange transportation (as needed) and other necessary support.
- \_\_\_\_\_ Select a list of guests that the mess desires to have attend their function.
- \_\_\_\_\_ Ensure invitations to guests are properly prepared and delivered.
- \_\_\_\_\_ Prepare a script for introductions and special toasts and prepare the working program for the event. Begin seating arrangements, decoration plans, and any other special arrangements that may be required.
- \_\_\_\_\_ Complete seating arrangement, conduct command briefing, finalize working program, and complete decoration plan.
- \_\_\_\_\_ Verify all requested support requirements, complete last minute liaison with all support agencies.
- \_\_\_\_\_ Select and brief escorts for guests as required, possible rehearsals for key figures.
- \_\_\_\_\_ Conduct a final walk-through inspection, see to the details. Brief the field music.
- \_\_\_\_\_ Ensure that a letter of appreciation is sent to the honored guest, coordinate with the treasurer of the facilities to complete all financial transactions.

2. The President will:

- a. Coordinate the activities of all representatives, ensuring deadlines are set and met.
- b. Select and properly invite the honored guest. At least 2 weeks prior to the event, ensure invitations to the guests are prepared and delivered.
- c. Designate escorts for the guests.
- d. Prepare a script to introduce guests.
- e. Select and acquire an appropriate gift for the guest of honor, appropriately engraved to signify the occasion.
- f. Complete letters of appreciation for support agencies.

3. Mr./Madam Vice will:

- a. Plan, coordinate and execute the entire mess night. The Marine is advised by the President and other members, but has the responsibility to the mess and President.
- b. Collects funds from members and conducts all financial transactions.
- c. Coordinates with the mess manager about numbers attending, facilities and such.

MARINE CORPS DRILL AND CEREMONIES MANUAL

d. Coordinates and supervises the treasurer and accounts for all monies received and expended.

D-9. GEAR LIST. The following is a list of equipment normally required to conduct a mess night.

1. Smoking Lamp.
2. Gavel.
3. Unit Colors (and guidons if applicable).
4. Officer or Noncommissioned Officer Sword (substitute a rifle and bayonet for field mess night).
5. Barracks cover with white cap (substitute a helmet for field mess night).
6. Purple Heart Medal.
7. Blank identification tags.
8. Black tablecloth with inverted dinner set (substitute a field mess gear during a field mess night).
9. One candle (preferably black).
10. Ships bell if the alternate to the traditional toasts is used per paragraph D-7.8.
11. Seating chart.

D-10. VARIATIONS. There are several variations to the mess night and include:

1. Field Mess Night. Also known as a "Warrior Night" or "Viking Night." Circumstances will frequently not permit a mess night with all the formalities as to uniform, catering, table, or services as detailed here. This should not deter an organization, however, and adaptations should be made to meet the "situation and terrain." Do not, in particular, let yourself become stupefied by the apparent formality of mess night; the object is the pleasure and camaraderie of all hands. The key words are conduct yourself with dignity and style. Some key elements that differ for a field mess night are:

a. Uniform. Normally the camouflage utility uniform with designated field equipment.

b. Meal. The meal may be modified from field rations to MREs.

c. Wines. Appropriate substitute beverages may have to be employed.

d. Decorations, table settings and the like will be modified to fit the situation.

e. Fallen Comrades Table. Modified for a field setting as shown in figure D-3. Figure D-3 shows a modified setting using only a field table. A second option is to take the helmet and bayonet from the table and placing them on a M16 rifle placed inverted in front of the table similar to the boot and rifle display used for memorial services in chapter 25.

f. These and any other modifications do not preclude the members of the mess from following the prescribed ceremonies for toasts, treatment of guests or other traditions.

g. During a field mess night certain rules of the mess may be relaxed by the President of the Mess in keeping with the informality of the evening.

2. Another variation of the Mess Night is a "Dining-Out." This is normally conducted in the same manner as a mess night with the exception that spouses and dates are invited. Specific rules such as fining need to be omitted or modified. A dining-out allows spouses to share in the camaraderie of the mess night.

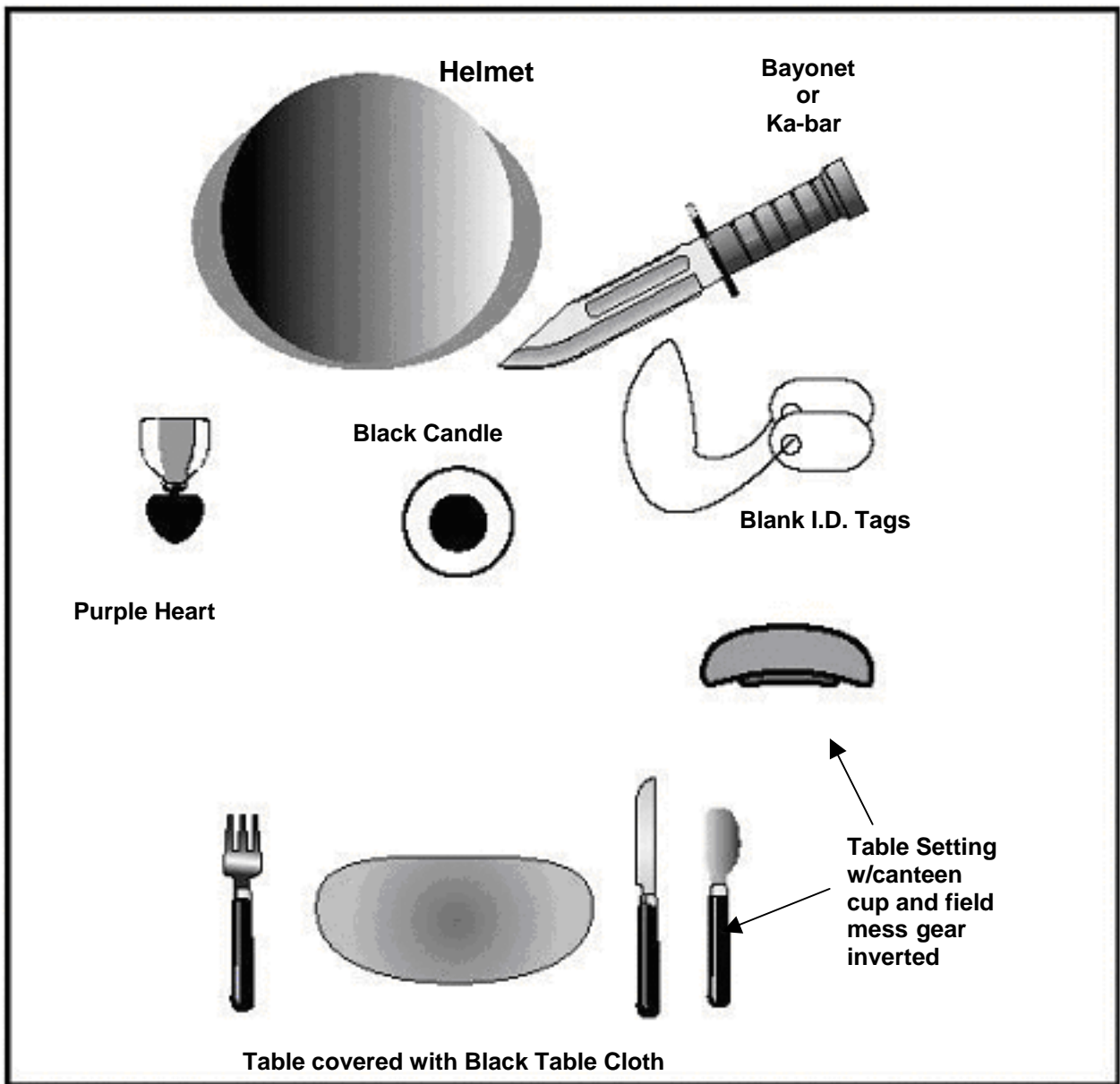

Figure D-3.--Fallen Comrades Table, Field Mess Night.